

**VARTON**



## About the company



Every day company "Varton" proves that the introduction of new technologies is necessary and the use of high-quality and durable materials is much more important than excessive reduction in production.



The company has production facilities in Russia. We provide the best quality of our products due to modern equipment and high-class element base.



## Production site

VARTON is a certified partner who will support you in creating both standard and individual projects around the world. From professional lighting solutions to production goods in our own factory - we will be able to fit even non-standard requirements.

### 1 PRODUCTION OF METAL CASES

10,000 cases per day  
3 automatic production lines  
200 different models per day  
Automatic production planning system

### 2 AUTOMATIC CONVEYOR PAINTING LINE

3 m per minute - painting speed  
Painting chamber and Gema automatic guns  
Raw materials: Jotun, AkzoNobel, Henkel

### 3 PLASTIC MOLDING PLOT

6000 items per day  
3 Automatic molding machines  
Robotic production  
Delale production 20-1000 g, size up to 1.2 m

### 4 ALUMINUM PROCESSING

500 items per day  
Use of machine tools with software control  
High precision machining and repeatability of items  
Processing of various aluminum profiles

### 5 ASSEMBLY WORKSHOP

Electronic accounting system of finished products  
Individual labeling of all products  
100% quality control

### 6 WAREHOUSE

6000 m<sup>2</sup> of storage space  
Automated storage and order matching system WMS

### 7 LABORATORY

Modern high-precision equipment Researches: light characteristics, CCT, IP, EMC, UGR, IK, light intensity curve, etc.

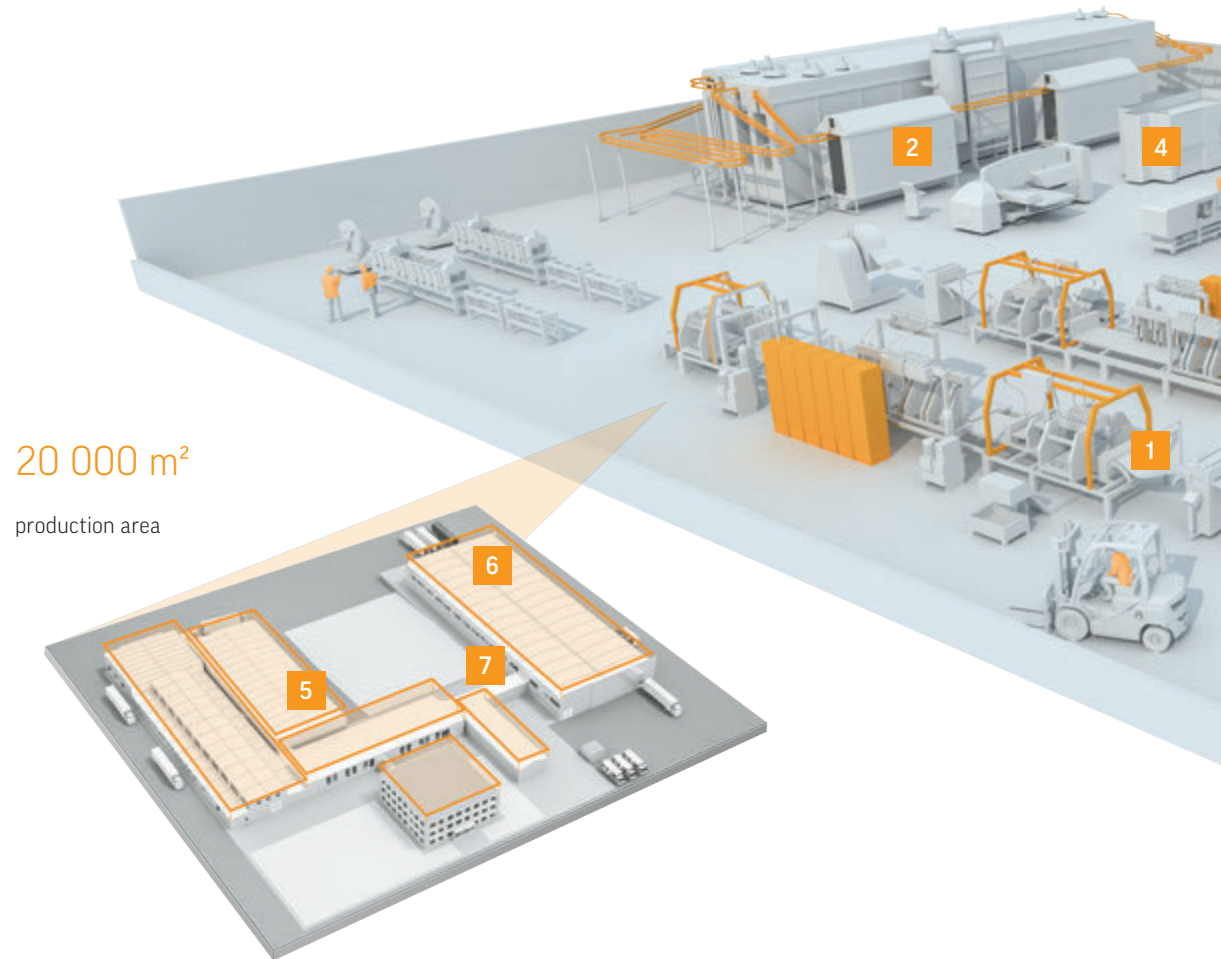

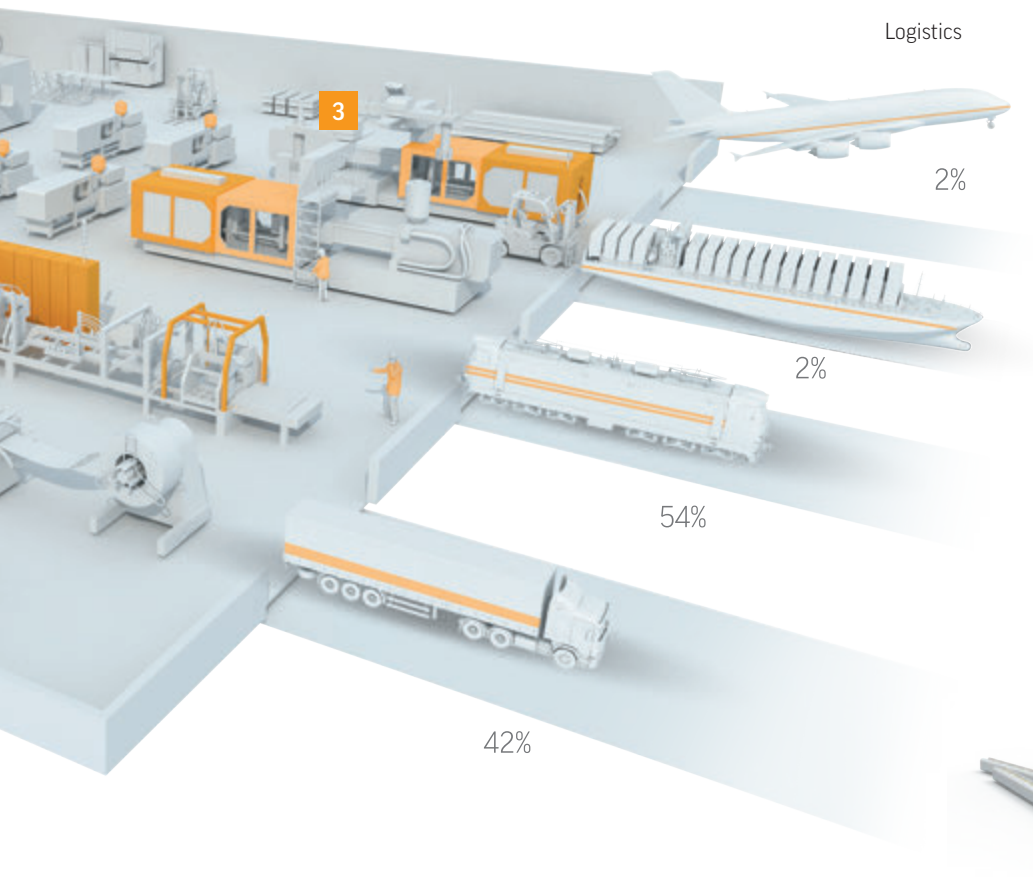

Quality Management System certified according to ISO9001 requirements



15 000

luminaires produced in a day

**17** seconds

production cycle of a single lamp

**24/7**

production mode

**50** series

products produced daily

**5**

international patents

Global suppliers



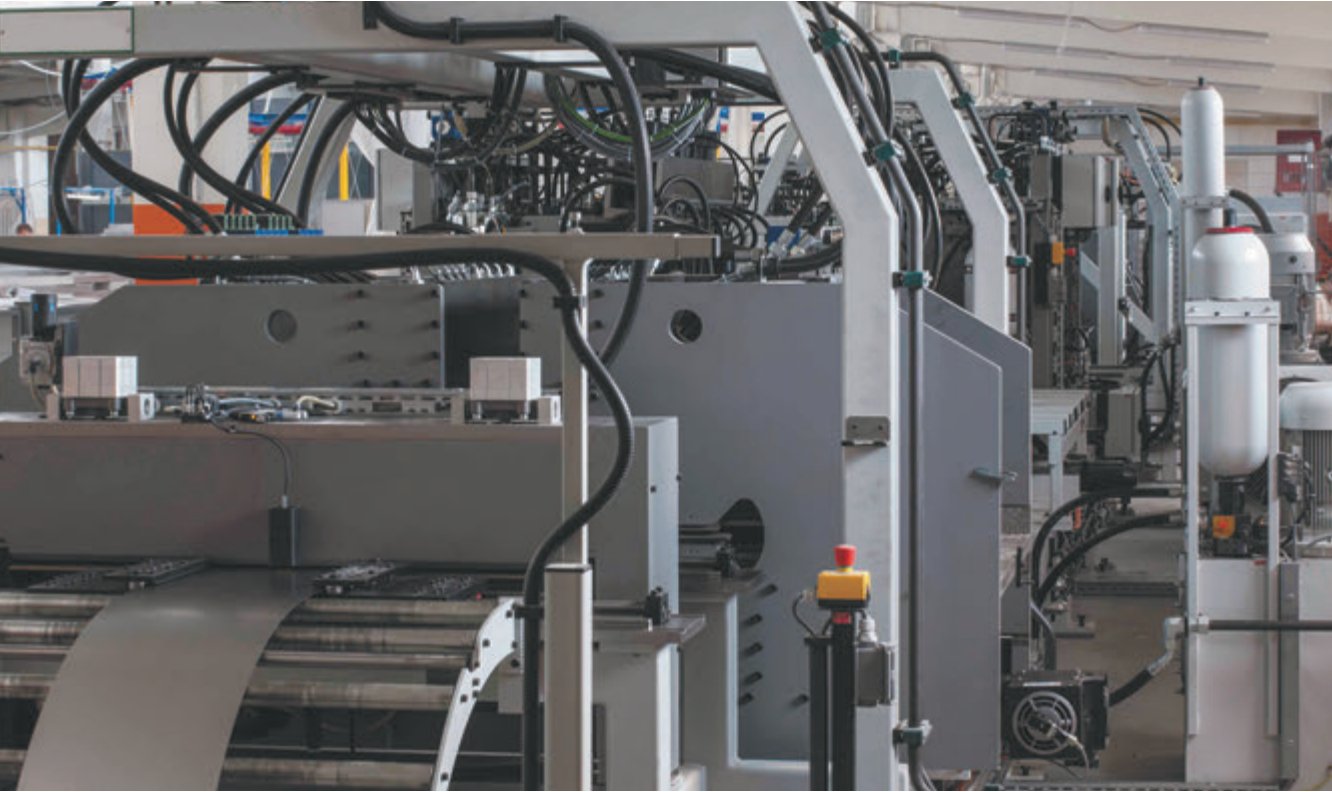

### Manufacture of metal cases

- ▶ **10 000 cases per day**
- ▶ 3 automatic production lines
- ▶ 200 different models per day
- ▶ Automatic production planning system

### Automatic conveyor painting line

- ▶ **4 m per minute painting speed**
- ▶ Painting booth and Gema automatic pistols
- ▶ Raw materials: Jotun, AkzoNobel, Henkel



### Plastic casting area

- ▶ **6000 items per day**
- ▶ 3 Automatic Molding Machine
- ▶ Manufacturing parts 20-1000 g, size up to 1.2 m
- ▶ Use of robots in production

### Aluminum processing

- ▶ **500 items per day**
- ▶ Use of machine tools with software control
- ▶ Precision machining and repeatability of products
- ▶ Processing of various aluminum profiles



### Assembly workshop

- ▶ **50 series of products produced per day**
- ▶ Electronic accounting system of released products
- ▶ Individual labeling of all products
- ▶ 100% quality control

### Warehouse

- ▶ **6000 m<sup>2</sup> of storage space**
- ▶ Automated storage and order picking system WMS 6000 m2

### Laboratory

- ▶ **Modern precision equipment**
- ▶ Research: light characteristics, CCT, IP, EMC, UGR, IK, light intensity curve, etc.



## Certification and quality

**The quality management system of the VartonGroup corresponds to international standard ISO 9001: 2015.** Technical control department supervises all stages of production.

**Certification under the Customs Union (CU), EAC marking.** Lighting products manufactured by the Varton Group of Companies pass mandatory confirmation of safety compliance according to the Technical Regulations of the Customs Union:- TR CU 004/2011 "On the safety of low-voltage equipment", approved by Decision of the Commission of the Customs Union (CCU) on August 16 2011 № 768.- TR TS 020/2011 "Electromagnetic compatibility of technical means ", approved by the Decision of the Commission of the Customs Union (CCU) on 9 December 2011 N 879. Conformity of manufactured products assessment to requirements of technical regulations of the Customs Union carried out before its released into usage. Documents of compliance are issued in accordance with the Decision of the Board of the Eurasian Economic Commission on 25 December 2012 №293 "On the unified forms of the certificate of conformity

and the declaration of compliance with the technical regulations of the Customs Union and their rules registration". The requirements of regulatory documents on sanitary-epidemiological and hygienic rules and regulations are strictly followed during production. Tests are conducted regularly by accredited laboratories of the Russian Federation. The products also undergo voluntary certification of fire and environmental safety.

**Certification in the European Union (EU), CE marking.** All lighting products supplied to the European Union (EU) are subject to conformity assessment with the requirements of the relevant EU Directives and are marked with CE sign. Testing on the harmonized European standards (EN) is carried out in accredited laboratories of EU countries, conformity assessment in the notified bodies, in particular, related to the German concern TUV NORD AG. Our products meet the requirements of: 2014/30/EU (Low Voltage Directive-LVD), 2014/35/EU (Electromagnetic Compatibility-EMC), 2011/65/EU (Restriction of Hazardous Substances), 2002/96/EU (Waste Electrical and Electronic Equipment Direc-

tive-WEEE), 2011/65/EU (Restriction of Hazardous Substances - RoHS). There is own lighting laboratory located on the production territory which allows a full range of lighting tests, EMC, and tests for dust and moisture protection (IP) of luminaires, degradation tests, climate tests, impact tests, vibration, etc.

**Company "Varton" is the official partner of Dialux. You can always find relevant data on our luminaires in the Dialux plug-in.**

## Features and benefits of VARTON LED luminaires













- ▶ The case of Tornado luminaire is made of aluminum by method of injection molding.
- ▶ The luminaire uses efficient degradation-resistant LEDs and reliable and time-tested drivers.
- ▶ The design of the luminaire allows you to use a widerange of lenses, achieving the light distribution required in a particular case.
- ▶ Universal bracket allows you to install the luminaire in the console as well as in the floor lamp position and also carry out a fine adjustment of the angle of the lamp.











- ▶ Tempered silicate glass reliably protects optical compartment from mechanical impact. Impact resistance of glass corresponds to IK09 according to IEC 62262:2002.
- ▶ Access to the driver compartment is carried out without a tool. The driver of the lamp is installed on the plate allowing to carry out.
- ▶ The voltage breaker allows safe access to the driver compartment without dismantling the luminaire.
- ▶ The luminaire is equipped with lightning protection with an exclusive level of withstanding voltage (12kV).









- ▶ Structurally the luminaire is divided into two temperature-independent cameras: the light compartment and the driver compartment. This separation minimizes the thermal effect of the driver on the LED module.
- ▶ The lamp has a high level of dust and water resistance. The degree of protection of the product is provided by the shell according to GOST 14254 - IP66).
- ▶ Pressure equalization valve prevents the appearance of moisture on the internal parts of the lamp.



# Symbols

## AREAS OF USE



-  Highways
-  Plants
-  Offices
-  Pharmacies, hospitals
-  Sales areas
-  Educational institutions
-  Stairways
-  Warehouse complexes
-  Cottage villages
-  Park areas



-  Hotels
-  Car washes
-  Aggressive environments
-  Agricultural complexes
-  Farms
-  Laboratories
-  Kitchens
-  Cleanrooms
-  Sport halls
-  Airports
-  Railway stations



-  AWADA Smart light
-  Emergency execution
-  Luminaires with a minimum level of visual discomfort
-  Dual illumination
-  Dimmable version of the protocol 1-10V
-  Version with microwave motion sensor
-  Dimmable version
-  Dimmable DALI protocol version
-  Low voltage version



-  Requirements of the letter of the Head of Rosпотребнадзор, G.G. Onishchenko from 01.10.2012 No. 01/11157-12-32 «On the organization of sanitary supervision over the use of energy-saving light sources»
-  SanPiN 2.4.2.2821-10 «Sanitary and epidemiological requirements for the conditions and organization of training in educational institutions» (with changes as of 25 December 2013);
-  SanPiN 2.2.1/2.1.1.1278-03 «Hygienic requirements to natural, artificial and combined lighting of residential and public buildings»

## SPECIFICATIONS

-  Unified sign of product circulation on the market of the Customs Union member states, confirming that the equipment complies with the mandatory requirements of the Technical Regulations
-  Confirmation of conformity of goods with GOST R 54350-2015
-  Proof of conformity of goods with the basic requirements of the EU

































































































































































-  Mark of conformity of products with the standards of Ukraine in the certification system UkrSEPRO
-  Sign of compliance with a high level of environmental safety
-  The company has implemented and successfully applied a quality management system at all stages of production and sales of products and services that meets the requirements of GOST ISO 9001-2015

-  Luminaires designed to be installed on the surface of normally flammable materials
-  Climatic version\*  
\*asterisk indicates a limited temperature range
-  The degree of dust and moisture protection of the luminaires

-  Sign of grounding, I class electrical safety from electric shock
-  II class electrical safety from electric shock
-  III class electrical safety from electric shock



# Series

 10 AWADA Smart Light	 13 Emergency evacuation lamps BASIC	 14 Emergency evacuation lamps BASIC	 14 Emergency evacuation lamps BASIC	 14 Emergency evacuation lamps BASIC	 15 Emergency downlight	 15 Emergency downlight	 15 Emergency downlight	 16 Emergency evacuation lamps ADVANCED	 18 Emergency evacuation lamps ADVANCED	 19 Emergency evacuation lamps ADVANCED	 19 Emergency evacuation lamps ADVANCED	 19 Emergency evacuation lamps ADVANCED	 20 Bend	 20 WALL-EM	 21 EM-Recovery Power Supplies	 21 EM-Recovery Power Supplies	 21 EM-Recovery Power Supplies	 23 FL-01	 24 FL-PRO	 26 Triumph HB
 29 LT-01	 30 Strong 2.0	 36 IP65 Strong	 42 Iron 2.0	 46 Iron 2.0 Lens	 48 Iron	 52 Iron Lens	 54 Iron Opal	 56 Olymp 2.0	 60 Olymp	 66 Olymp S10	 67 Olymp HB	 68 Olimp K	 69 Olymp Mini	 72 Olimp Round	 74 Tornado	 77 Uran/ Uran Xtrem/ Uran P	 84 Uran Mini	 86 Village/ Village L120	 87 Triumph	 88 Retro
 90 Professional LED tape	 98 Nimbus	 100 Flex 50	 102 WL-Cube IP54	 103 WL-Tube IP54	 104 TT-Mono	 106 TT-Vivo	 110 TT-01 2.0	 111 TT-02 2.0	 112 TT-Stellar	 113 TT-Prisma	 114 TT-01	 115 TT-02	 116 Busway	 119 Universal- Line	 122 G-Line	 125 Mercury Mall IP54	 127 Mercury Mall	 131 Supermarket		
 135 Stellar-Line	 137 Q-40	 138 Q-80	 140 R-Line	 141 T-Line	 145 DL-Slim	 146 DL-Pro	 148 DL-01	 150 DL-02	 152 DL-03	 154 DL-Lens	 156 DL-Spark	 158 DL-Stellar	 159 DL-Tetris	 160 DL/R	 163 C PANEL IP65	 164 C170/NGL	 165 C350/GL	 166 C070, C070/N	 167 C070/GL, C070/NGL	 168 C270, C270/N
 172 E070	 173 E270	 174 E220	 175 S070	 177 S270	 178 S170	 180 TAB	 181 NERO	 182 AERO	 183 HCS	 184 HCS Round	 185 Lux	 188 Panel 300	 189 Panel 370	 190 Panel Comfort 350	 191 Panel Comfort 070	 192 Panel 070	 169 C170, C170/N	 170 C350, C350/N		
 195 SOFT/OT Comfort	 196 LINEA	 197 Solo	 199 A070 2.0	 200 A070	 201 Lamps with uniform illumination	 203 A400	 203 A420	 204 A450	 205 A470	 206 A070, A070/S	 207 A070, A070/S	 208 A070, A070/S	 226 Varton for SL2*	 227 Varton for Vector*	 229 Varton for MicroLook*	 232 Varton for Clip-In*	 233 Varton for Clip-In*	 242 GR 070 2.0	 243 GR 490/F	 244 GR070
 210 A270	 213 A170	 214 A220	 215 A370	 216 A350	 217 G070	 218 G270	 219 A070/OT	 220 A300	 221 AL220	 222 AL270	 223 AL170	 234 Varton for V-Clip*	 235 Varton for Tegular*	 236 Varton for Finesse*	 237 Varton for Ecophon	 238 Varton for Cesal	 245 GR070/F	 247 GR170/F	 248 GR270/F	
 251 A070 Basic	 252 A170 Basic	 253 A270 Basic	 254 FL Basic	 255 Strong Basic	 256 Iron Basic	 257 TT-Basic	 258 GR070 Basic	 259 DL-Basic	 260 JKKX Basic	 261 Sensors and control systems	 270 LED T8	 271 High Power L.	 272 Low- Voltage L.	 274 Iron Agro	 276 Iron PHYTO	 277 Iron Lens PHYTO	 279 Olimp PHYTO			

# Content and catalog navigation

01	About the company
10	AWADA Smart Light
12	Emergency solutions
22	Spotlights
28	Industrial solutions
73	Outdoor solutions
89	Decorative solutions
105	Accent solutions
118	Linear recessed solutions
124	Linear pendant solutions
134	Pendant and surface mounted solutions
144	Downlights
161	Lighting for clean and medical solutions
171	Lighting for educational institutions
180	Lighting for housing and utilities objects
186	Panels
194	Administrative solutions
224	Special ceiling solutions
240	Grilato
250	Basic series
261	Sensors and control systems
268	Light sources
273	Agro lighting
275	Phyto Lighting
283	Information

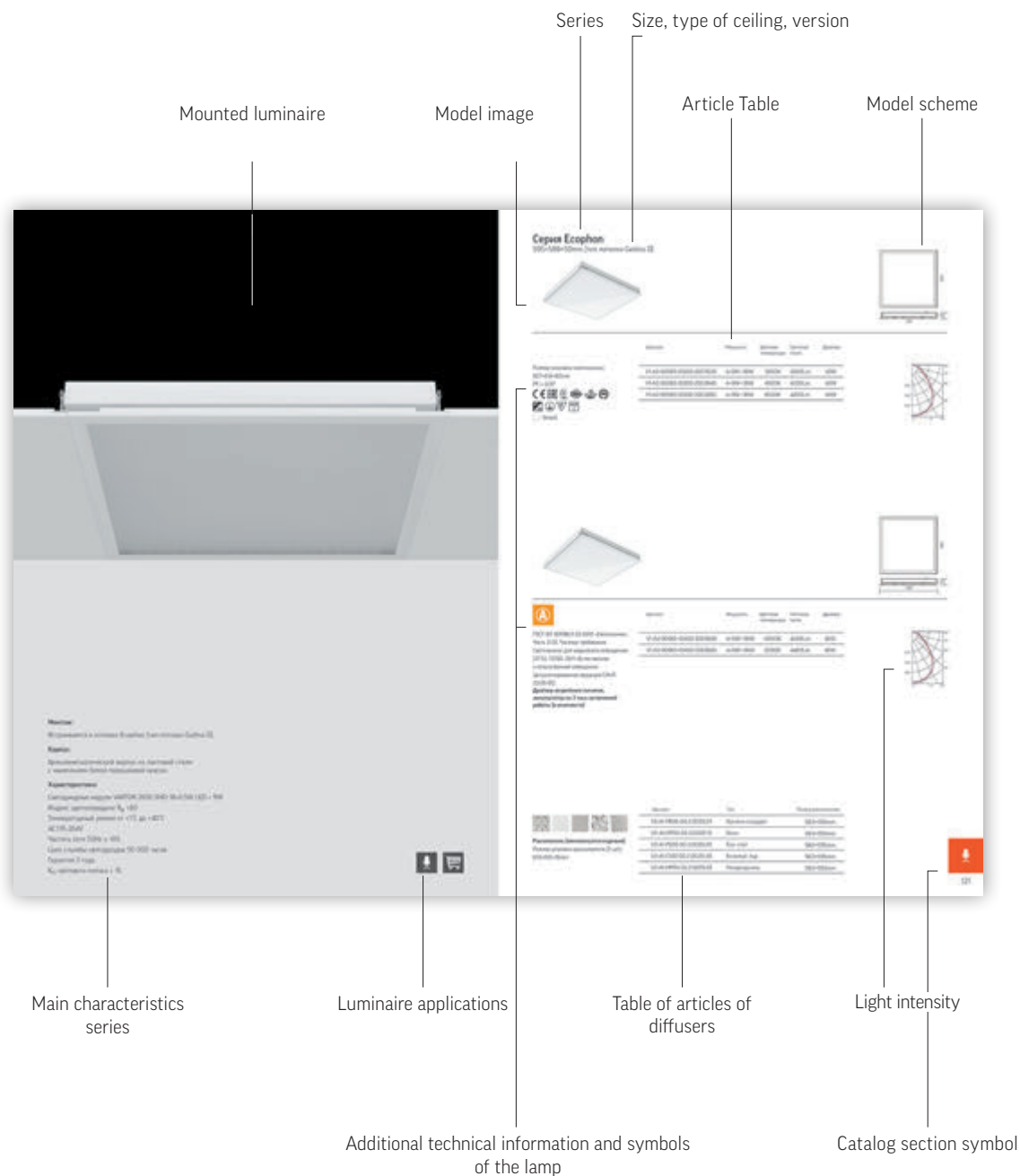

## AWADA Smart Light



AWADA lighting control system from Varton is an advanced proven protocol DALI based technology.

### Why do you need it:

up to 85% of additional energy savings; creature of common control systems for all equipment in buildings (lighting, air conditioning, ventilation, video surveillance, etc.); comfort and high-quality light environment for work and life; contribution to environmental protection. Varton™ projects use equipment only from leading European companies and meet the most stringent requirements and pass all the necessary tests. Any Varton™ luminaire can be manufactured with the DALI protocol and/or with variable color temperature. With complex supplies of systems and equipment we guarantee the compatibility of all systems.

With the help of our experts you can get a solution for any project from small to large, from simple to complex, from economical to premium. The system can work both in manual and automatic mode; constantly maintain the same luminous flux, taking into account daylight; study in a short time and adjust to a specific room. The system may include various sensors and additional equipment working not only on DALI protocol, but also on other control protocols (ZigBee, KNX, etc.).

### The first training systems for lighting control.



Simple and convenient interface

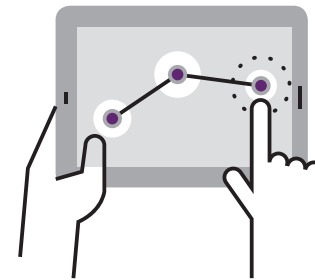

Automatic and manual control



Integration with the DALI system

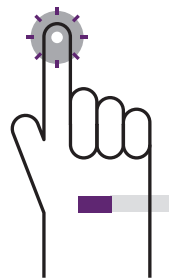

Intuitive control on the 3D-scheme



Possibility of training the system



Cost control and management



## Energy saving

### Fine-tuning of illumination

The setting of scenes with dimming of each individual luminaire allows you to compensate for areas with excessive illumination, achieving optimal illumination of all space while reducing the overall energy consumption.

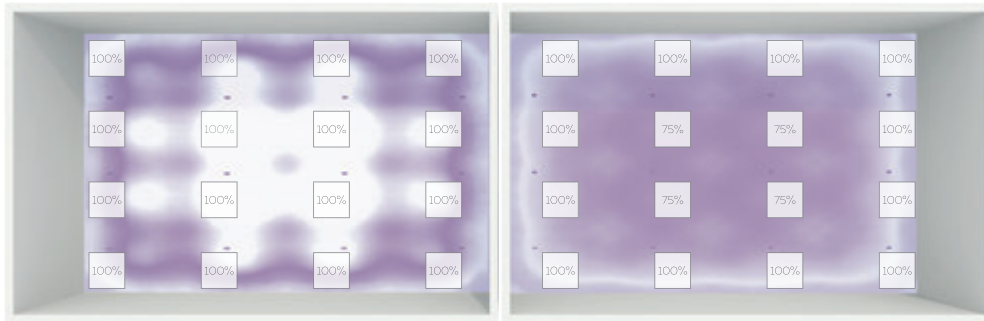

100% brightness of luminaires

Lamps with individually configured brightness

### Intellectual presence control

The use of presence sensors, coupled with the AWADA learning function, allows you to create not only energy-efficient, but also comfortable lighting at the facility. Forget about the effect of traffic lights and steps into a dark room, turning off the light when you do not expect it. The system allows you to customize the behavior of lighting as you need, smoothly increasing the illumination in areas where there are people, and smoothly lowering it to the standby mode in empty rooms.

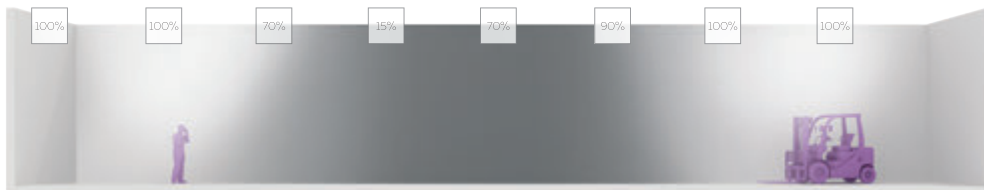

### Use of daylight

With windows or skylights, sunlight is a great opportunity not to spend extra money. The system itself controls the desired level, providing the ability to manually adjust if necessary.

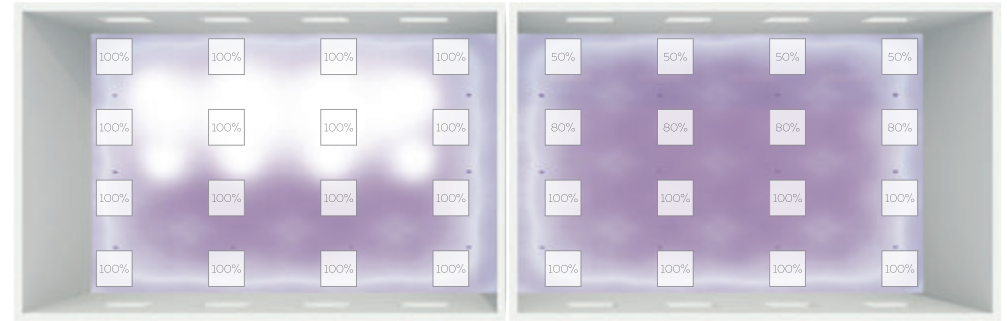

100% brightness of luminaires

The brightness of the lamps with the external light source

### Real Time Monitoring

In the AWADA application you will not only see the current state of each lamp at the facility but you can also build energy graphs for any zone/floor/building for the period of time that interests you and upload this data in the Exel format.

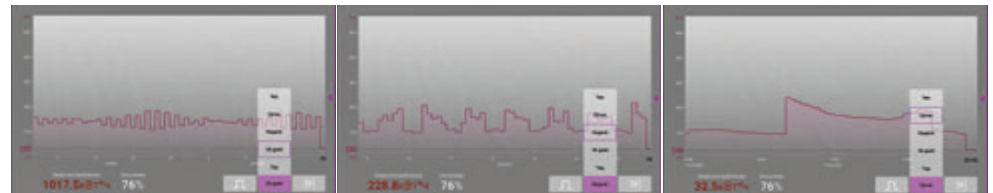



**EMERGENCY EVACUATION LIGHTING**

# EMERGENCY EVACUATION LAMPS AND LIGHT INDICATORS



BASIC SERIES

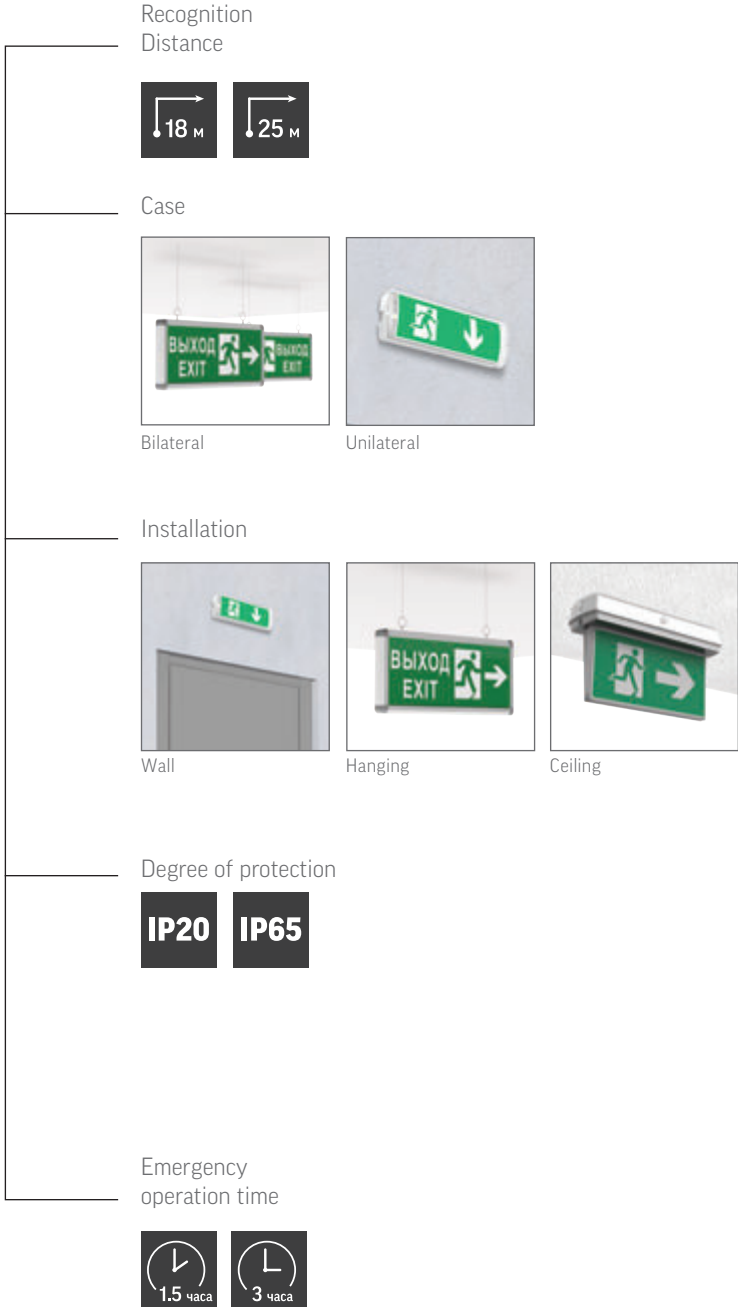



## Light indicators IP20 Basic

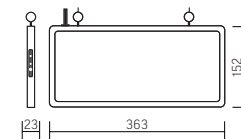

Aluminium case  
Type of action: permanent  
Package size of the lamp:  
375×30×175mm



○ metallic

Article	Recognition Distance	Power	Power Operating time from the built-in battery	Version	Dimensions
V1-R0-70354-02A02-2000365	25 m	3W	1,5 h	Unilateral	363x152x23 mm

Pictogram applied to the glass.

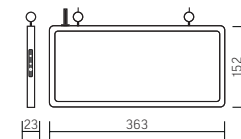

Aluminium case  
Type of action: permanent  
Package size of the lamp:  
375×30×175mm

○ metallic

Article	Recognition Distance	Power	Power Operating time from the built-in battery	Version	Dimensions
V1-R0-70354-02A02-2100365	25 m	3W	1,5 h	Unilateral	363x152x23 mm

Pictogram applied to the glass.

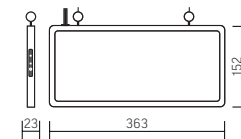

Aluminium case  
Type of action: permanent  
Package size of the lamp:  
375×30×175mm

○ metallic

Article	Recognition Distance	Power	Power Operating time from the built-in battery	Version	Dimensions
V1-R0-70354-02A02-2200365	25 m	3W	1,5 h	Unilateral	363x152x23 mm

Pictogram applied to the glass.

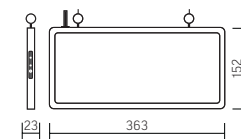

Aluminium case  
Type of action: permanent  
Package size of the lamp:  
375×30×175mm

○ metallic

Article	Recognition Distance	Power	Power Operating time from the built-in battery	Version	Dimensions
V1-R0-70354-02A02-2300365	25 m	3W	1,5 h	Unilateral	363x152x23 mm

Pictogram applied to the glass.

### Installation:

Suspended or overhead installation for all types of ceilings

### Diffuser:

Strained glass

### Specifications:

Color index Ra > 75

Temperature range from + 1°C to + 40°C

AC176-264V

Network frequency 50Hz ± 10%

2 year warranty

Luminous flux Kn ≤ 3%



## Luminous pointer IP20 Basic Unilateral

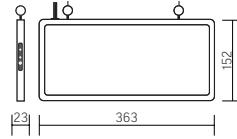

Aluminium case  
Type of action: permanent  
Package size of the lamp:  
375×30×175mm

Article	Recognition Distance	Power	Power Operating time from the built-in battery	Version	Dimensions
V1-R0-70354-02A02-2400365	25 м	3W	1,5 h	Unilateral	363x152x23 mm

Pictogram purchased separately.



○ metallic

### Pictograms for emergency luminaires IP20 BASIC:



## Emergency Downlight IP65 Basic

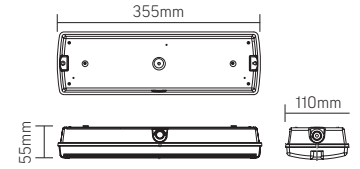

Case material: incombustible polycarbonate  
Action Type: permanent / non-permanent  
Package size of the lamp:  
365×65×120mm

Article	Power	Luminous flux working/ emergency	Version	Power Operating time from the built-in battery	Recognition Distance	Dimensions
V1-R0-70355-21A01-2000165	3,5W	130/140lm	Unilateral	3 h	18 м	355x110x55mm

Pictogram purchased separately.



○ white

### Pictograms for emergency luminaires IP65 BASIC:



## Emergency Downlight Basic

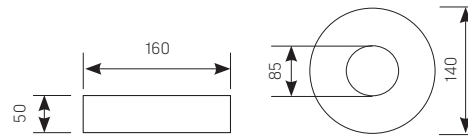

Case material: polycarbonate  
Action Type: Intermittent

Article	Power	Luminous flux working/ emergency	Operating time from the built-in battery	Dimensions, mm
V1-R0-00349-10A02-2000300	1,7W	~110 lm	3 h	Ø140(85) x20mm Power Supply 160x50x35mm



○ white

### Accessories for the lamp IP65 Basic:



Article	Description	Recognition Distance	Dimensions
V4-R0-70355-21A01-6500165	Replaceable two-sided matt diffuser	30м	355x110x180mm
V4-R0-00355-21A01-2000165	Protective grid	-	390x134x70mm





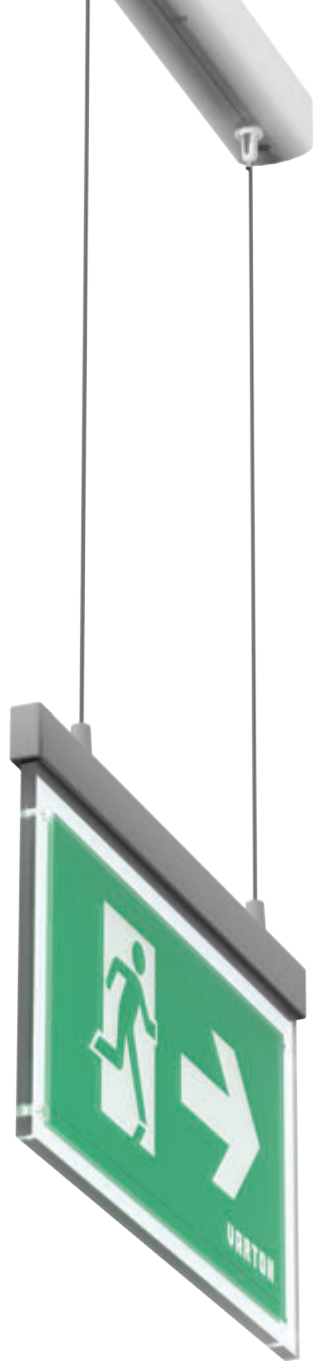

# EMERGENCY EVACUATION LAMPS AND LIGHT INDICATORS

ADVANCED SERIES



Recognition Distance



Case



Bilateral



Unilateral

Installation

Low degree of protection



Wall



Hanging



Ceiling



Side



Built-in

High degree of protection



Wall



Built-in



Ceiling

Modifications



Self diagnostic system



Group diagnostic system

Advantage



Emergency operation time



Plastic case resistant to burning



Unified Pictogram Illumination



Pictogram compliance with GOST requirements





**Installation:**  
All available types of installation

**Case:**  
Polycarbonate

**Diffuser:**  
Polycarbonate

**Specifications:**  
Color transmission index Ra > 80  
Temperature range from +1°C to +45°C  
AC220-240V  
Network frequency 50Hz ± 10%  
3 year warranty  
Luminous flux Kn ≤ 3%

**Advanced Series**



**Luminous pointer Flip**

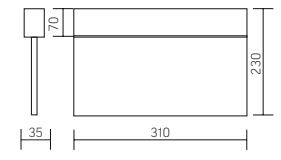

Case material polycarbonate Type of action: permanent	Article	Recognition Distance	Power	Operating time on internal battery	Dimensions
--	---------	----------------------	-------	------------------------------------	------------



V1-EM-70432-02A01-4000365	27m	3W	3 h	310x230x35mm
---------------------------	-----	----	-----	--------------

Two Pictograms are included with the Luminous pointer Flip that indicate the direction of the exit to right and left.

**Mounting kits for Flip Light Index**

	Article	Application
	V4-EM-00.0018.ADV-0001	For embedded mounting
	V4-EM-00.0005.ADV-0002	For side mounting/end mounting



**Luminous pointer Flip Hanging**

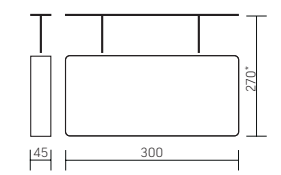

Case material polycarbonate Type of action: permanent / non-permanent	Article	Recognition Distance	Power	Operating time on internal battery	Dimensions
--	---------	----------------------	-------	------------------------------------	------------



V1-EM-70432-30A01-4000365	27m	3W	3 h	300x270x45mm
---------------------------	-----	----	-----	--------------

\* The height of the lamp is indicated with a minimum length of hangers (20mm). Maximum length of built-in hangers is 600mm.  
Two Pictograms are included with the Luminous pointer Flip Hanging that indicate the direction of the exit to right and left



### Luminous pointer Vision

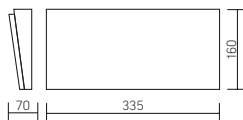

Case material polycarbonate  
Type of action: permanent / non-permanent

Article	Recognition Distance	Power	Operating time on internal battery	Dimensions
V1-EM-00432-21A01-4000365	30m	3W	3 h	335x160x70mm



○ white

Pictogram purchased separately.

### Series Advanced IP65



### Luminous pointer Resist

NEW MODEL

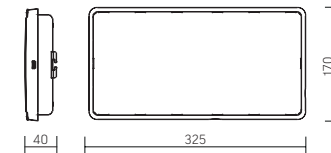

Case material polycarbonate  
Type of action: permanent / non-permanent

Article	Recognition Distance	Power	Operating time on internal battery	Dimensions
V1-EM-70432-02A01-4000365	30m	5W	3 h	325x170x40mm



○ white

The light pointer is suitable for installation in drywall, mounting springs included.  
Two Pictograms are included with the Luminous pointer Resist that indicate the direction of the exit to right and left.

### Pictograms for the Series Advanced



Flip V4-EM-00.0035.ADV-0003  
Vision V5-EM03-60.003.024  
Compact V5-EM04-60.004.024



Flip V4-EM-00.0035.ADV-0005  
Vision V5-EM03-60.003.021  
Compact V5-EM04-60.004.021



Flip V4-EM-00.0035.ADV-0008  
Vision V5-EM03-60.003.018  
Compact V5-EM04-60.004.018



Flip complete with lamp  
Vision V5-EM03-60.003.022  
Compact V5-EM04-60.004.022  
Resist complete with lamp



Flip V4-EM-00.0035.ADV-0001  
Vision V5-EM03-60.003.003  
Compact V5-EM04-60.004.003  
Resist V4-EM-00.0057.ADV-0001



Flip complete with lamp  
Vision V5-EM03-60.003.019  
Compact V5-EM04-60.004.019  
Resist complete with lamp



Flip V4-EM-00.0035.ADV-0004  
Vision V5-EM03-60.003.023  
Compact V5-EM04-60.004.023



Flip V4-EM-00.0035.ADV-0006  
Vision V5-EM03-60.003.016  
Compact V5-EM04-60.004.016



Flip V4-EM-00.0035.ADV-0004  
Vision V5-EM03-60.003.017  
Compact V5-EM04-60.004.017



Flip V4-EM-00.0035.ADV-0002  
Vision V5-EM03-60.003.013  
Compact V5-EM04-60.004.013



Flip V4-EM-00.0035.ADV-0011



Flip V4-EM-00.0035.ADV-0041  
Resist V4-EM-00.0057.ADV-0041  
Token V4-EM-00.0060.ADV-0041



### Emergency Evacuation Lamp Token

NEW MODEL

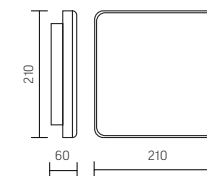

Case material polycarbonate  
Type of action: permanent



○ white

Article	Recognition Distance	Power	Luminous flux working / emergency	Operating time on internal battery	Dimensions
V1-EM-00432-01A01-6501065	40m	10W	900/600 lm	3 h	210x210x60mm

Pictogram purchased separately.



### Emergency evacuation luminaire Compact

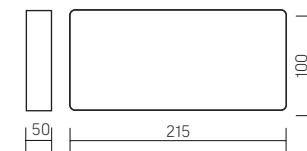

Case material polycarbonate  
Type of action: permanent / non-permanent



○ white

Article	Recognition Distance	Power	Luminous flux working / emergency	Operating time on internal battery	Dimensions
V1-EM-00432-01A01-6500265	18m	2,5W	150/150lm	3 h	215x100x50mm

Pictogram purchased separately



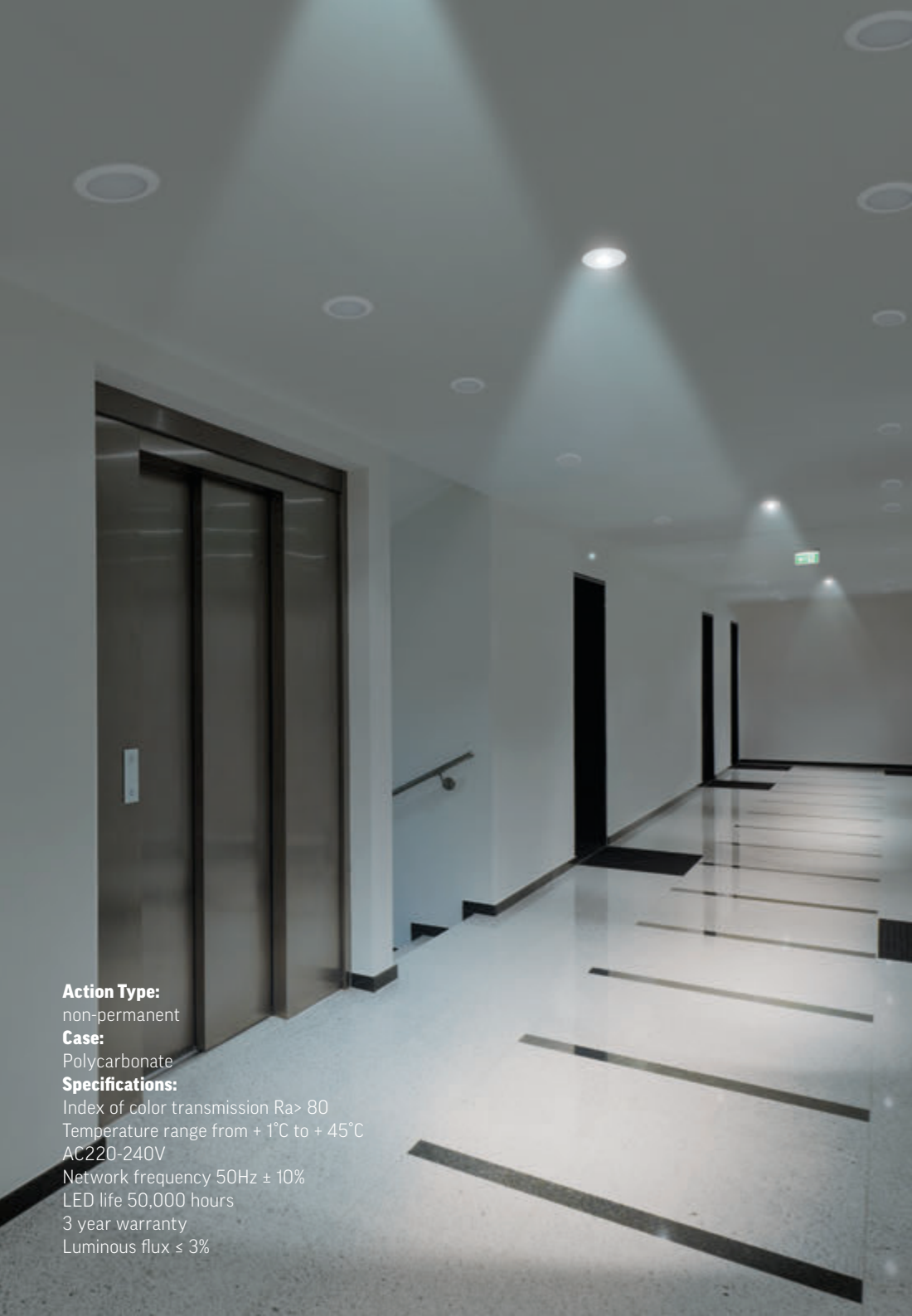

**Action Type:**  
non-permanent

**Case:**  
Polycarbonate

**Specifications:**  
Index of color transmission Ra > 80  
Temperature range from +1°C to +45°C  
AC220-240V  
Network frequency 50Hz ± 10%  
LED life 50,000 hours  
3 year warranty  
Luminous flux ≤ 3%

## Emergency lighting Bend



NEW  
MODEL

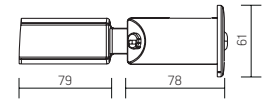

Case material polycarbonate  
Type of action: non-permanent



○ white

Article	Luminous flux working / emergency	Operating time from the built-in battery	Optics	Dimensions
V1-EM-00479-10A00-2000465	- / 350 lm	1 h	For open space	Ø60x80mm +Bt. Ø40x85mm

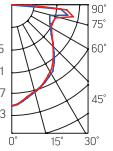

NEW  
MODEL

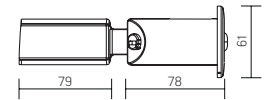

Case material polycarbonate  
Type of action: non-permanent

○ white

Article	Luminous flux working / emergency	Operating time from the built-in battery	Optics	Dimensions
V1-EM-00480-10A00-2000465	- / 350 lm	1 h	For corridor	Ø60x80mm + Bt. Ø40x85mm

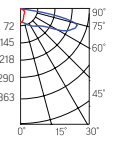

## Emergency lighting Wall-EM

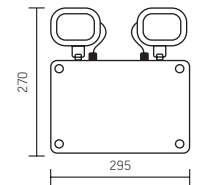

Case material polycarbonate  
Type of action: non-permanent



○ white

Article	Luminous flux working / emergency	Operating time from the built-in battery	Dimensions
V1-EM-00432-01A01-6500265	- / 700lm	3 h	295x270x75mm

## Emergency power supplies 100% EM-Recovery



NEW MODEL

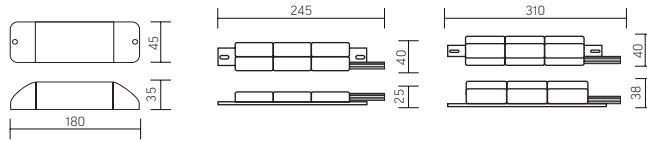

Case material: polycarbonat



○ white

Article	Max. lamp power	Luminous flux in emergency mode	Emergency operation time	Dimensions
V1-EM-00478-21A01-4002000	20W	100%	At least 1 hour	180x45x35mm + Bt. 245x40x25mm
V1-EM-00478-21A01-4004000	40W	100%	At least 1 hour	180x45x35mm + Bt. 245x40x25mm



NEW MODEL

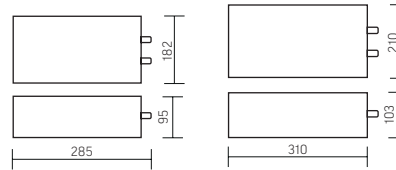

Case material: polycarbonat



○ white

Article	Max. lamp power	Luminous flux in emergency mode	Emergency operation time	Dimensions
V1-EM-00478-21A01-6512000	120W	100%	At least 1 hour	285x182x95mm
V1-EM-00478-21A01-6520000	200W	100%	At least 1 hour	310x210x103mm

## Emergency power supplies EM-Utility



NEW MODEL

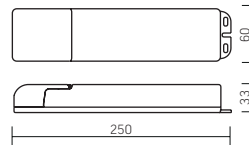

Case material: polycarbonat



○ white

Article	Output voltage	Output voltage UPS	Luminous flux in emergency mode	Operating time from the built-in battery	Dimensions
V1-EM-00478-21A01-2000400	10-90B	2/4B <sub>T</sub>	10-30%*	3/1,5 h	250x60x33mm

\* • calculated relative to the power of the connected lamp.

NEW MODEL

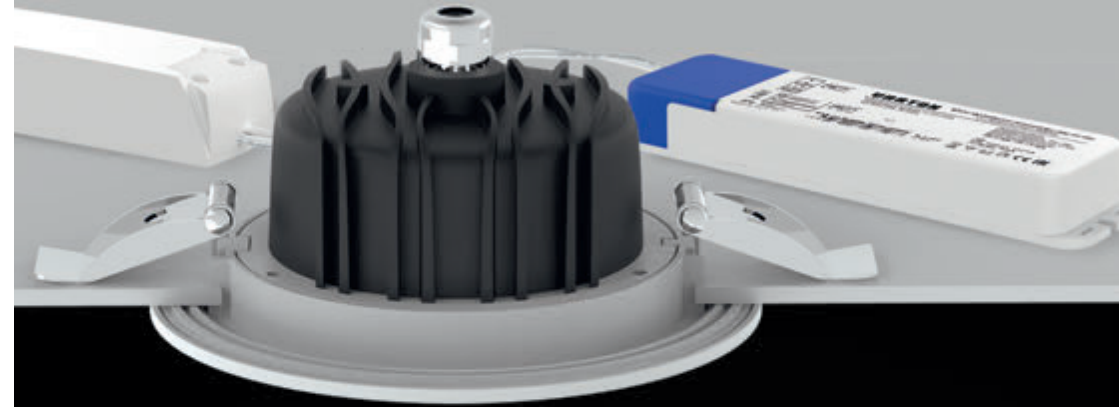

### Installation:

Outside / inside luminaire

### Case:

Polycarbonate

### Specifications:

Temperature range from +1°C to +40°C

AC220-240V

Network frequency 50Hz +/- 10%

Test button, charge indicator included

Application:

Together with LED lamps for emergency lighting



**SPOTLIGHTS**



## FL-01

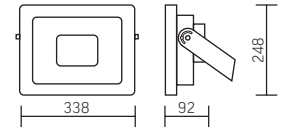

Angle of rotation - 180°  
Radiation angle - 120°  
Lamp Size:  
338 × 248 × 92mm  
Package size of the lamp:  
375 × 305 × 140 mm  
PF ≥ 0.9



● grey

Article	Power	Light temperature	Luminous flux
V1-I0-70474-04L05-6510040	100W	4000K	11500lm
V1-I0-70474-04L05-6515040	150W	4000K	17250lm
V1-I0-70474-04L05-6510050	100W	5000K	11500lm
V1-I0-70474-04L05-6515050	150W	5000K	17250lm

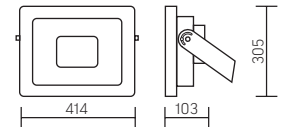
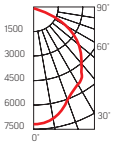

Angle of rotation - 180°  
Radiation angle - 120°  
Lamp Size:  
414×305×103mm  
Package size of the lamp:  
455×365×140 mm  
PF ≥ 0.9



● grey

Article	Power	Light temperature	Luminous flux
V1-I0-70475-04L05-6520040	200W	4000K	23000lm
V1-I0-70475-04L05-6520050	200W	5000K	23000lm

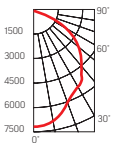

**Installation:**  
Mount to walls, ceiling and floor with the option of tilt angle adjustment within 180°

**Case:**  
Cast aluminum housing  
Swivel bracket.

**Application:**  
Designed for warehouses, access areas, exhibition grounds, architectural lighting elements, buildings, etc.

**Specifications:**  
Index of color transmission  $R_a > 75$   
Temperature range from -20° C to + 45° C  
AC220-240V  
Network frequency 50Hz ± 10%  
LED life 50,000 hours  
3 year warranty  
Luminous flux  $K_n < 5$





NEW  
MODEL



**Installation:**

Mount to walls, ceiling and floor with the option of tilt angle adjustment within 180 °

**Case:**

Aluminium case. Strained glass.

**Application:**

The lamp is designed to illuminate industrial premises, sports facilities and architectural lighting.

**Specifications:**

Index of color transmission Ra > 75  
 Temperature range from -40 ° C to 45 ° C  
 AC 100-305V, 47-63Hz, DC 142-431V  
 LED life 50,000 hours  
 3 year warranty  
 Luminous flux Kn ≤5%  
 PF≥0,96



FL-PRO



NEW  
MODEL

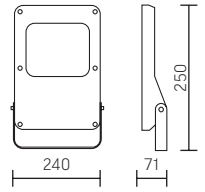

Angle of rotation: 180 °  
 Lamp Size:  
 240x250x71 mm



● grey

Article	Power, W	LT, K	Luminous flux, lm	Radiation angle
V1-I0-H0589-04L40-6605030	50	3000	6250	20
V1-I0-H0589-04L40-6605040	50	4000	6750	20
V1-I0-H0589-04L40-6605050	50	5000	6750	20
V1-I0-H0589-04L02-6605030	50	3000	6250	30
V1-I0-H0589-04L02-6605040	50	4000	6750	30
V1-I0-H0589-04L02-6605050	50	5000	6750	30
V1-I0-H0589-04L07-6605030	50	3000	6250	60
V1-I0-H0589-04L07-6605040	50	4000	6750	60
V1-I0-H0589-04L07-6605050	50	5000	6750	60
V1-I0-H0589-04L41-6605030	50	3000	6250	80
V1-I0-H0589-04L41-6605040	50	4000	6750	80
V1-I0-H0589-04L41-6605050	50	5000	6750	80
V1-I0-H0589-04L42-6605030	50	3000	6250	30x50
V1-I0-H0589-04L42-6605040	50	4000	6750	30x50
V1-I0-H0589-04L42-6605050	50	5000	6750	30x50
V1-I0-H0589-04L40-6607530	75	3000	8625	20
V1-I0-H0589-04L40-6607540	75	4000	9375	20
V1-I0-H0589-04L40-6607550	75	5000	9375	20
V1-I0-H0589-04L02-6607530	75	3000	8625	30
V1-I0-H0589-04L02-6607540	75	4000	9375	30
V1-I0-H0589-04L02-6607550	75	5000	9375	30
V1-I0-H0589-04L07-6607530	75	3000	8625	60
V1-I0-H0589-04L07-6607540	75	4000	9375	60
V1-I0-H0589-04L07-6607550	75	5000	9375	60
V1-I0-H0589-04L41-6607530	75	3000	8625	80
V1-I0-H0589-04L41-6607540	75	4000	9375	80
V1-I0-H0589-04L41-6607550	75	5000	9375	80
V1-I0-H0589-04L42-6607530	75	3000	8625	30x50
V1-I0-H0589-04L42-6607540	75	4000	9375	30x50
V1-I0-H0589-04L42-6607550	75	5000	9375	30x50

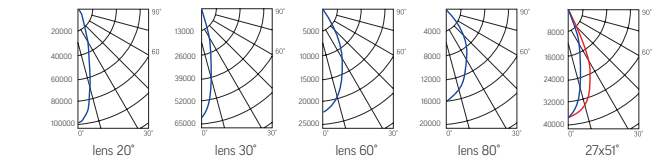

# FL-PRO



NEW MODEL

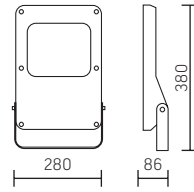

Angle of rotation: 180°  
Lamp Size:  
280x380x86 mm



Article	Power, W	LT, K	Luminous flux, lm	Radiation angle
V1-10-H0590-04L40-6610030	100	3000	12500	20
V1-10-H0590-04L40-6610040	100	4000	13500	20
V1-10-H0590-04L40-6610050	100	5000	13500	20
V1-10-H0590-04L02-6610030	100	3000	12500	30
V1-10-H0590-04L02-6610040	100	4000	13500	30
V1-10-H0590-04L02-6610050	100	5000	13500	30
V1-10-H0590-04L07-6610030	100	3000	12500	60
V1-10-H0590-04L07-6610040	100	4000	13500	60
V1-10-H0590-04L07-6610050	100	5000	13500	60
V1-10-H0590-04L41-6610030	100	3000	12500	80
V1-10-H0590-04L41-6610040	100	4000	13500	80
V1-10-H0590-04L41-6610050	100	5000	13500	80
V1-10-H0590-04L42-6610030	100	3000	12500	30x50
V1-10-H0590-04L42-6610040	100	4000	13500	30x50
V1-10-H0590-04L42-6610050	100	5000	13500	30x50
V1-10-H0590-04L40-6612030	120	3000	13800	20
V1-10-H0590-04L40-6612040	120	4000	15000	20
V1-10-H0590-04L40-6612050	120	5000	15000	20
V1-10-H0590-04L02-6612030	120	3000	13800	30
V1-10-H0590-04L02-6612040	120	4000	15000	30
V1-10-H0590-04L02-6612050	120	5000	15000	30
V1-10-H0590-04L07-6612030	120	3000	13800	60
V1-10-H0590-04L07-6612040	120	4000	15000	60
V1-10-H0590-04L07-6612050	120	5000	15000	60
V1-10-H0590-04L41-6612030	120	3000	13800	80
V1-10-H0590-04L41-6612040	120	4000	15000	80
V1-10-H0590-04L41-6612050	120	5000	15000	80
V1-10-H0590-04L42-6612030	120	3000	13800	30x50
V1-10-H0590-04L42-6612040	120	4000	15000	30x50
V1-10-H0590-04L42-6612050	120	5000	15000	30x50

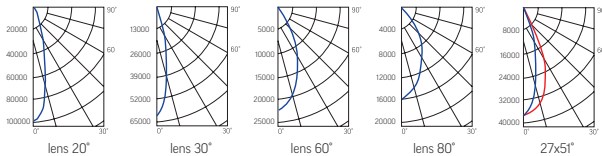

# FL-PRO



NEW MODEL

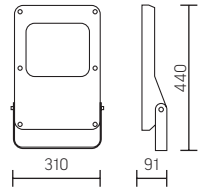

Angle of rotation: 180°  
Lamp Size:  
310x440x91 mm



Article	Power, W	LT, K	Luminous flux, lm	Radiation angle
V1-10-H0591-04L40-6615030	150	3000	18750	20
V1-10-H0591-04L40-6615040	150	4000	20250	20
V1-10-H0591-04L40-6615050	150	5000	20250	20
V1-10-H0591-04L02-6615030	150	3000	18750	30
V1-10-H0591-04L02-6615040	150	4000	20250	30
V1-10-H0591-04L02-6615050	150	5000	20250	30
V1-10-H0591-04L07-6615030	150	3000	18750	60
V1-10-H0591-04L07-6615040	150	4000	20250	60
V1-10-H0591-04L07-6615050	150	5000	20250	60
V1-10-H0591-04L41-6615030	150	3000	18750	80
V1-10-H0591-04L41-6615040	150	4000	20250	80
V1-10-H0591-04L41-6615050	150	5000	20250	80
V1-10-H0591-04L42-6615030	150	3000	18750	30x50
V1-10-H0591-04L42-6615040	150	4000	20250	30x50
V1-10-H0591-04L42-6615050	150	5000	20250	30x50
V1-10-H0591-04L40-6620030	200	3000	23000	20
V1-10-H0591-04L40-6620040	200	4000	25000	20
V1-10-H0591-04L40-6620050	200	5000	25000	20
V1-10-H0591-04L02-6620030	200	3000	23000	30
V1-10-H0591-04L02-6620040	200	4000	25000	30
V1-10-H0591-04L02-6620050	200	5000	25000	30
V1-10-H0591-04L07-6620030	200	3000	23000	60
V1-10-H0591-04L07-6620040	200	4000	25000	60
V1-10-H0591-04L07-6620050	200	5000	25000	60
V1-10-H0591-04L41-6620030	200	3000	23000	80
V1-10-H0591-04L41-6620040	200	4000	25000	80
V1-10-H0591-04L41-6620050	200	5000	25000	80
V1-10-H0591-04L42-6620030	200	3000	23000	30x50
V1-10-H0591-04L42-6620040	200	4000	25000	30x50
V1-10-H0591-04L42-6620050	200	5000	25000	30x50

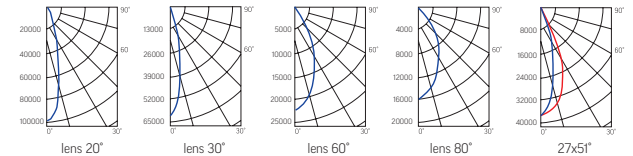



## Triumph HB

430×330×142mm

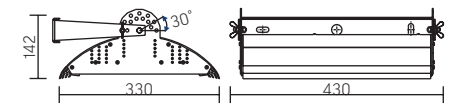
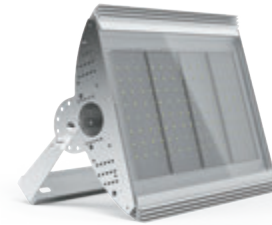

Protective glass:  
Strained glass 4mm  
Angle of light scattering 120°  
Package size of the lamp:  
450×335×150mm  
PF ≥ 0,97



○ metallic

Article	Power	Light temperature	Luminous flux
V1-10-70056-04L05-6506065	60W	6500K	6900lm
V1-10-70056-04L05-6509065	90W	6500K	10350lm
V1-10-70056-04L05-6512065	120W	6500K	13800lm

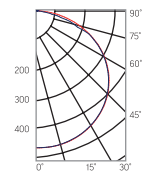

**Installation:**  
Mount to walls, ceiling and floor with the option of tilt angle adjustment within 180 °

**Case:**  
Anodized Aluminum Case  
Stainless steel swivel bracket

**Application:**  
Designed for warehouses, access areas, exhibition sites, lighting architectural elements, buildings, etc.

**Specifications:**  
Index of color transmission Ra > 75  
Temperature range from -40 °C to + 45 °C  
AC100-305V  
Network frequency 50Hz ± 10%  
LED life 50,000 hours  
3 year warranty  
Luminous flux Kn <1%



# Triumph HB floodlight mounting methods

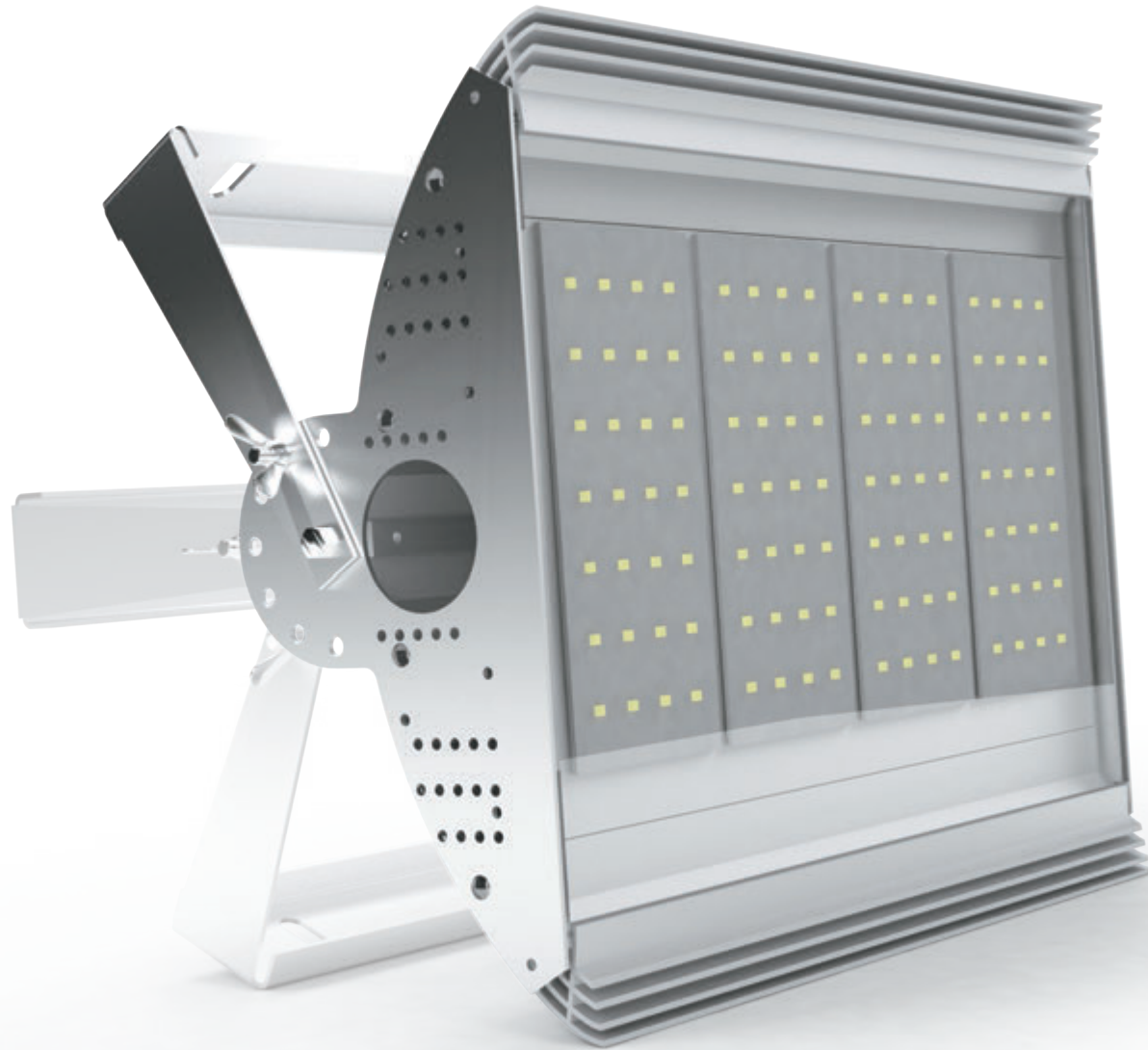

Spotlight Rotation Angle - 180°



Ceiling mounting



Wall mounting

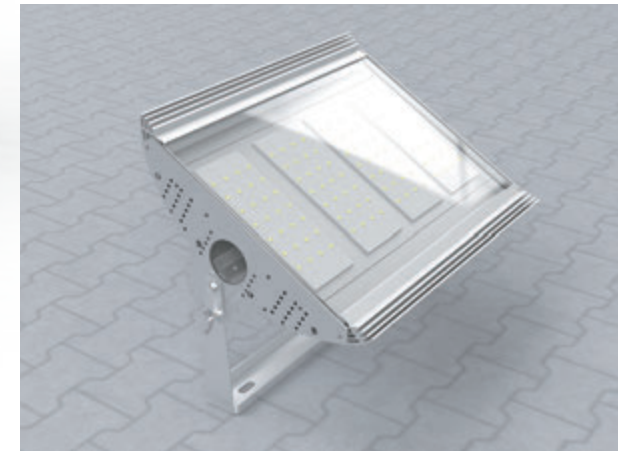

Floor mounting



Plant "Tetra Pak" (Moscow, Russia)



**INDUSTRIAL LIGHTING**

LT-01

NEW MODEL



NEW MODEL

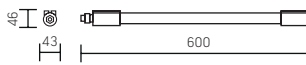

Lamp Size:  
600×43×46 mm  
PF ≥ 0,97

Article

Power

Colour temperature

Luminous flux

V1-I0-70536-02G02-6501340	13W	4000K	1495lm
V1-I0-70536-02G02-6501350	13W	5000K	1495lm

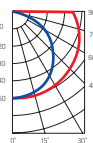

○ white



NEW MODEL

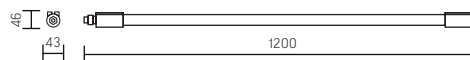

Lamp Size:  
1200×43×46 mm  
PF ≥ 0,97

Article

Power

Colour temperature

Luminous flux

V1-I0-70537-02G02-6502540	25W	4000K	2875lm
V1-I0-70537-02G02-6502550	25W	5000K	2875lm

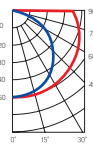

○ white



NEW MODEL

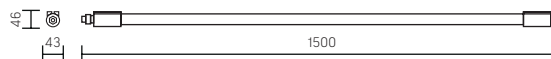

Lamp Size:  
1500×43×46 mm  
PF ≥ 0,97

Article

Power

Colour temperature

Luminous flux

V1-I0-70538-02G02-6503240	32W	4000K	3680lm
V1-I0-70538-02G02-6503250	32W	5000K	3680lm

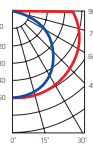

○ white



**Installation:**

Fastening on a horizontal or vertical surface. Possibility of mounting on hangers.

**Case / Diffuser:**

High impact polycarbonate

**Specifications:**

II class electrical safety

Index of color transmission Ra > 80

Temperature range from -20 ° C to + 40 ° C

Luminous flux Kn ≤5%

LED life 50,000 hours

3 year warranty





## STRONG 2.0

Linear lamp  
Plastic case  
IP65



Dimensions

**16W**



674 mm

**30W**

**45W**



1242 mm

Versions



Dimming protocol DALI



Emergency version



Low voltage version



Touch version

Optics





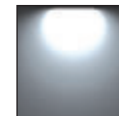

Clear diffuser



Matt diffuser

Light temperature

-  3000K Warm white
-  4000K Neutral white
-  5000K Cold white
-  6500K Cold white





NEW  
MODEL



## Strong 2.0

1242×90×68mm

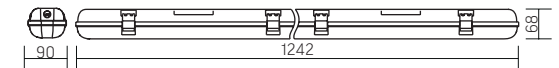

AC176-264V  
Package size of the lamp:  
1278×98×56mm  
Kn<2%  
PF ≥ 0,95  
Ra>84



Article	Power	Light temperature	Light flow	Diffuser	Clear diffuser
V1-I2-70210-03G02-6503065	30W	6500K	3600lm	Matt	
V1-I2-70210-03G02-6504565	45W	6500K	5400lm	Matt	
V1-I2-70210-03G00-6503065	30W	6500K	3900lm	Clear	
V1-I2-70210-03G00-6504565	45W	6500K	5850lm	Clear	
V1-I2-70210-03G02-6503050	30W	5000K	3600lm	Matt	
V1-I2-70210-03G02-6504550	45W	5000K	5400lm	Matt	
V1-I2-70210-03G00-6503050	30W	5000K	3900lm	Clear	
V1-I2-70210-03G00-6504550	45W	5000K	5850lm	Clear	
V1-I2-70210-03G02-6503040	30W	4000K	3600lm	Matt	
V1-I2-70210-03G02-6504540	45W	4000K	5400lm	Matt	
V1-I2-70210-03G00-6503040	30W	4000K	3900lm	Clear	
V1-I2-70210-03G00-6504540	45W	4000K	5850lm	Clear	
V1-I2-70210-03G02-6503030	30W	3000K	3240lm	Matt	
V1-I2-70210-03G02-6504530	45W	3000K	4860lm	Matt	
V1-I2-70210-03G00-6503030	30W	3000K	3510lm	Clear	
V1-I2-70210-03G00-6504530	45W	3000K	5265lm	Clear	

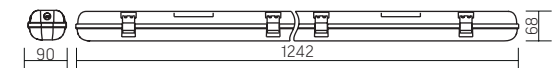

DC24-36V  
PF ≥ 0,97



Article	Power	Light temperature	Light flow	Diffuser	Clear diffuser
V1-I2-70210-03N02-6503065	30W	6500K	3600lm	Matt	
V1-I2-70210-03N02-6504565	45W	6500K	5400lm	Matt	
V1-I2-70210-03N00-6503065	30W	6500K	3900lm	Clear	
V1-I2-70210-03N00-6504565	45W	6500K	5850lm	Clear	
V1-I2-70210-03N02-6503050	30W	5000K	3600lm	Matt	
V1-I2-70210-03N02-6504550	45W	5000K	5400lm	Matt	
V1-I2-70210-03N00-6503050	30W	5000K	3900lm	Clear	
V1-I2-70210-03N00-6504550	45W	5000K	5850lm	Clear	
V1-I2-70210-03N02-6503040	30W	4000K	3600lm	Matt	
V1-I2-70210-03N02-6504540	45W	4000K	5400lm	Matt	
V1-I2-70210-03N00-6503040	30W	4000K	3900lm	Clear	
V1-I2-70210-03N00-6504540	45W	4000K	5850lm	Clear	
V1-I2-70210-03N02-6503030	30W	3000K	3240lm	Matt	
V1-I2-70210-03N02-6504530	45W	3000K	4860lm	Matt	
V1-I2-70210-03N00-6503030	30W	3000K	3510lm	Clear	
V1-I2-70210-03N00-6504530	45W	3000K	5265lm	Clear	

### Installation:

Mount directly on a horizontal or vertical surface  
Can be mounted on hangers

### Case:

High impact self-extinguishing ABS plastic  
It is completed with wearproof cable input

### Diffuser:

Polycarbonate with UV stabilizer additives  
Mounted to the body of the lamp on the latches

### Specifications:

Index of color transmission Ra > 80  
Temperature range from -40 °C to + 45 °C  
Network frequency 50Hz ± 10%  
LED life 50,000 hours  
3 year warranty  
Luminous flux Kn <1%



**Strong 2.0**  
1242×90×68mm

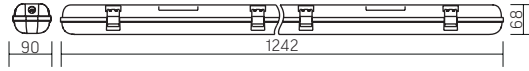

**DALI**

AC176-264V  
PF ≥ 0,97

Article	Power	Light temperature	Light flow	Diffuser	Matt Diffuser	Clear Diffuser
V1-I2-70210-03D02-6503065	30W	6500K	3600lm	Matt		
V1-I2-70210-03D02-6504565	45W	6500K	5400lm	Matt		
V1-I2-70210-03D00-6503065	30W	6500K	3900lm	Clear		
V1-I2-70210-03D00-6504565	45W	6500K	5850lm	Clear		
V1-I2-70210-03D02-6503050	30W	5000K	3600lm	Matt		
V1-I2-70210-03D02-6504550	45W	5000K	5400lm	Matt		
V1-I2-70210-03D00-6503050	30W	5000K	3900lm	Clear		
V1-I2-70210-03D00-6504550	45W	5000K	5850lm	Clear		
V1-I2-70210-03D02-6503040	30W	4000K	3600lm	Matt		
V1-I2-70210-03D02-6504540	45W	4000K	5400lm	Matt		
V1-I2-70210-03D00-6503040	30W	4000K	3900lm	Clear		
V1-I2-70210-03D00-6504540	45W	4000K	5850lm	Clear		
V1-I2-70210-03D02-6503030	30W	3000K	3240lm	Matt		
V1-I2-70210-03D02-6504530	45W	3000K	4860lm	Matt		
V1-I2-70210-03D00-6503030	30W	3000K	3510lm	Clear		
V1-I2-70210-03D00-6504530	45W	3000K	5265lm	Clear		

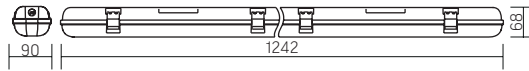

**SENSOR**

AC176-264V  
PF ≥ 0,97

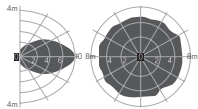

Article	Power	Light temperature	Light flow	Diffuser	Matt Diffuser	Clear Diffuser
V1-I2-70210-03S02-6503065	30W	6500K	3600lm	Matt		
V1-I2-70210-03S02-6504565	45W	6500K	5400lm	Matt		
V1-I2-70210-03S00-6503065	30W	6500K	3900lm	Clear		
V1-I2-70210-03S00-6504565	45W	6500K	5850lm	Clear		
V1-I2-70210-03S02-6503050	30W	5000K	3600lm	Matt		
V1-I2-70210-03S02-6504550	45W	5000K	5400lm	Matt		
V1-I2-70210-03S00-6503050	30W	5000K	3900lm	Clear		
V1-I2-70210-03S00-6504550	45W	5000K	5850lm	Clear		
V1-I2-70210-03S02-6503040	30W	4000K	3600lm	Matt		
V1-I2-70210-03S02-6504540	45W	4000K	5400lm	Matt		
V1-I2-70210-03S00-6503040	30W	4000K	3900lm	Clear		
V1-I2-70210-03S00-6504540	45W	4000K	5850lm	Clear		
V1-I2-70210-03S02-6503030	30W	3000K	3240lm	Matt		
V1-I2-70210-03S02-6504530	45W	3000K	4860lm	Matt		
V1-I2-70210-03S00-6503030	30W	3000K	3510lm	Clear		
V1-I2-70210-03S00-6504530	45W	3000K	5265lm	Clear		

**Strong 2.0**  
1242×90×68mm

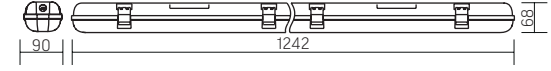

**A Autonomous emergency lamp constant action**

Emergency power supply unit, battery for 1 hour of autonomous operation, charge indicator, "Test" button in the set (see description on page 266)

**Conformity:**  
Standard IEC 60598-2-22:2012 "Luminaires. Part 2-22. Private requirements. Luminaires for emergency lighting"  
SP 52. 13330. 2011 "Natural and artificial lighting" (updated edition of SNiP 23.05-95)

Article	Power	Light temperature	Light flow	Diffuser
V1-I2-70210-03A02-6503065	30W	6500K	3600lm	Matt
V1-I2-70210-03A02-6504565	45W	6500K	5400lm	Matt
V1-I2-70210-03A00-6503065	30W	6500K	3900lm	Clear
V1-I2-70210-03A00-6504565	45W	6500K	5850lm	Clear
V1-I2-70210-03A02-6503050	30W	5000K	3600lm	Matt
V1-I2-70210-03A02-6504550	45W	5000K	5400lm	Matt
V1-I2-70210-03A00-6503050	30W	5000K	3900lm	Clear
V1-I2-70210-03A00-6504550	45W	5000K	5850lm	Clear
V1-I2-70210-03A02-6503040	30W	4000K	3600lm	Matt
V1-I2-70210-03A02-6504540	45W	4000K	5400lm	Matt
V1-I2-70210-03A00-6503040	30W	4000K	3900lm	Clear
V1-I2-70210-03A00-6504540	45W	4000K	5850lm	Clear
V1-I2-70210-03A02-6503030	30W	3000K	3240lm	Matt
V1-I2-70210-03A02-6504530	45W	3000K	4860lm	Matt
V1-I2-70210-03A00-6503030	30W	3000K	3510lm	Clear
V1-I2-70210-03A00-6504530	45W	3000K	5265lm	Clear

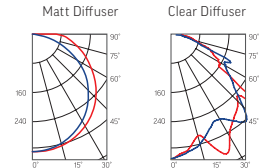



## Strong 2.0

674×90×68mm

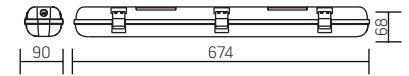

AC176-264V  
Package size of the lamp:  
674×90×68mm

$K_{T1} < 2\%$   
 $PF \geq 0,95$   
 $R_a > 84$



IP65  
metal

Article	Power	Light temperature	Luminous flux*	Diffuser
V1-12-70215-03G02-6501665	16W	6500K	1920lm	Matt
V1-12-70215-03G00-6501665	16W	6500K	2080lm	Clear
V1-12-70215-03G02-6501650	16W	5000K	1920lm	Matt
V1-12-70215-03G00-6501650	16W	5000K	2080lm	Clear
V1-12-70215-03G02-6501640	16W	4000K	1920lm	Matt
V1-12-70215-03G00-6501640	16W	4000K	2080lm	Clear
V1-12-70215-03G02-6501630	16W	3000K	1728lm	Matt
V1-12-70215-03G00-6501630	16W	3000K	1872lm	Clear

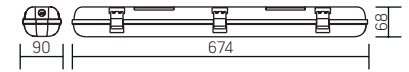
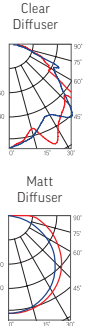

DC24-36V  
 $PF \geq 0,97$

metal

Article	Power	Light temperature	Luminous flux*	Diffuser
V1-12-70215-03N02-6501665	16W	6500K	1920lm	Matt
V1-12-70215-03N00-6501665	16W	6500K	2080lm	Clear
V1-12-70215-03N02-6501650	16W	5000K	1920lm	Matt
V1-12-70215-03N00-6501650	16W	5000K	2080lm	Clear
V1-12-70215-03N02-6501640	16W	4000K	1920lm	Matt
V1-12-70215-03N00-6501640	16W	4000K	2080lm	Clear
V1-12-70215-03N02-6501630	16W	3000K	1728lm	Matt
V1-12-70215-03N00-6501630	16W	3000K	1872lm	Clear

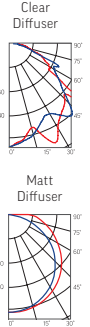

### Installation:

Mount directly on a horizontal or vertical surface  
Can be mounted on hangers

### Case:

High impact self-extinguishing ABS plastic  
It is completed with wearproof cable input

### Diffuser:

Polycarbonate with UV stabilizer additives  
Mounted to the body of the lamp on the latches

### Specifications:

Index of color transmission  $R_a > 80$   
Temperature range from  $-40^\circ\text{C}$  to  $+45^\circ\text{C}$   
LED life 50,000 hours  
3 year warranty  
Luminous flux  $K_n < 2\%$



## Strong 2.0

674×90×68mm

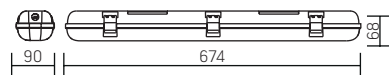

### DALI

AC176-264V  
PF ≥ 0,97

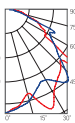
Article	Power	Light temperature	Luminous flux*	Diffuser	Clear Diffuser
V1-I2-70215-03D02-6501665	16W	6500K	1920lm	Matt	
V1-I2-70215-03D00-6501665	16W	6500K	2080lm	Clear	
V1-I2-70215-03D02-6501650	16W	5000K	1920lm	Matt	
V1-I2-70215-03D00-6501650	16W	5000K	2080lm	Clear	
V1-I2-70215-03D02-6501640	16W	4000K	1920lm	Matt	
V1-I2-70215-03D00-6501640	16W	4000K	2080lm	Clear	
V1-I2-70215-03D02-6501630	16W	3000K	1728lm	Matt	
V1-I2-70215-03D00-6501630	16W	3000K	1872lm	Clear	

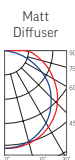

## Strong 2.0

674×90×68mm

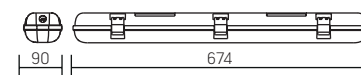

### Autonomous emergency lamp constant action

Emergency power supply unit battery for 1 hour of autonomous operation, charge indicator, "Test" button in the set (see description on page 266)

### Conformity:

Standard IEC 60598-2-22-2012 «Luminaires. Part 2-22. Private requirements. Luminaires for emergency lighting »  
SP 52. 13330. 2011 "Natural and artificial lighting" (updated edition of SNiP 23.05-95)

Article	Power	Light temperature	Luminous flux*	Diffuser	Clear Diffuser
V1-I2-70215-03A02-6501665	16W	6500K	1920lm	Matt	
V1-I2-70215-03A00-6501665	16W	6500K	2080lm	Clear	
V1-I2-70215-03A02-6501650	16W	5000K	1920lm	Matt	
V1-I2-70215-03A00-6501650	16W	5000K	2080lm	Clear	
V1-I2-70215-03A02-6501640	16W	4000K	1920lm	Matt	
V1-I2-70215-03A00-6501640	16W	4000K	2080lm	Clear	
V1-I2-70215-03A02-6501630	16W	3000K	1728lm	Matt	
V1-I2-70215-03A00-6501630	16W	3000K	1872lm	Clear	

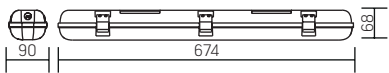
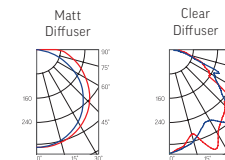

AC176-264V  
PF ≥ 0,97

metal

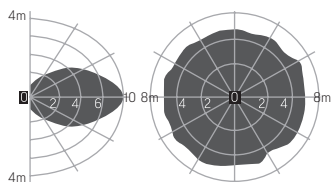

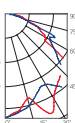
Article	Power	Light temperature	Luminous flux*	Diffuser	Clear Diffuser
V1-I2-70215-03S02-6501665	16W	6500K	1920lm	Matt	
V1-I2-70215-03S00-6501665	16W	6500K	2080lm	Clear	
V1-I2-70215-03S02-6501650	16W	5000K	1920lm	Matt	
V1-I2-70215-03S00-6501650	16W	5000K	2080lm	Clear	
V1-I2-70215-03S02-6501640	16W	4000K	1920lm	Matt	
V1-I2-70215-03S00-6501640	16W	4000K	2080lm	Clear	
V1-I2-70215-03S02-6501630	16W	3000K	1728lm	Matt	
V1-I2-70215-03S00-6501630	16W	3000K	1872lm	Clear	

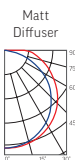

\* Luminous Flux Set excluding the diffuser





# STRONG

Linear lamp  
Plastic case  
IP65



Dimensions

**18W** **27W**



674 mm

**36W** **54W**



1242 mm

Versions



Dimming protocol DALI



Emergency version



Low voltage version



Touch version

Optics



Clear Diffuser



Matt Diffuser

Light temperature

-  3000K Warm white
-  4000K Neutral white
-  5000K Cold white
-  6500K Cold white





## IP65 Strong

1242x90x68mm

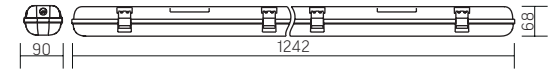

AC176-264V  
 Package size of the lamp:  
 1278x98x56mm  
 PF ≥ 0,97



○ metal

Article	Power	Light temperature	Luminous flux*	Matt Diffuser	Clear Diffuser
V1-I0-70210-03000-6501840	18W	4000K	2100lm		
V1-I0-70210-03000-6501850	18W	5000K	2100lm		
V1-I0-70210-03000-6501865	18W	6500K	2200lm		
V1-I0-70210-03000-6503640	36W	4000K	4200lm		
V1-I0-70210-03000-6503650	36W	5000K	4200lm		
V1-I0-70210-03000-6503665	36W	6500K	4400lm		
V1-I0-70210-03000-6505440	54W	4000K	6300lm		
V1-I0-70210-03000-6505450	54W	5000K	6300lm		
V1-I0-70210-03000-6505465	54W	6500K	6600lm		

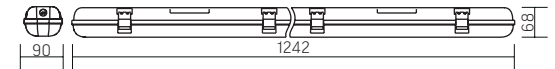

DC24-36V  
 PF ≥ 0,97



○ metal

Article	Power	Light temperature	Luminous flux*	Matt Diffuser	Clear Diffuser
V1-I0-70210-03N00-6501840	18W	4000K	2100lm		
V1-I0-70210-03N00-6501850	18W	5000K	2100lm		
V1-I0-70210-03N00-6501865	18W	6500K	2200lm		
V1-I0-70210-03N00-6503640	36W	4000K	4200lm		
V1-I0-70210-03N00-6503650	36W	5000K	4200lm		
V1-I0-70210-03N00-6503665	36W	6500K	4400lm		



### Diffuser (optional)

Pack size of the lens (3 pieces):  
 1281x98x81mm

### Diffuser (optional)

Pack size of the lens (3 pieces):  
 688\*98\*81mm

Article	Type	Diffuser size
V2-I0-IPPO-02.3.0210.18	Clear	1242x90x68mm
V2-I0-IPMO-02.3.0210.18	Matt	1242x90x68mm

Article	Type	Diffuser size
V2-I0-IPPO-02.3.0215.18	Clear	674x90x68mm
V2-I0-IPMO-02.3.0215.18	Matt	674x90x68mm

\*Luminous Flux Set excluding the diffuser

### Installation:

Mount directly on a horizontal or vertical surface  
 Can be mounted on hangers

### Case:

High impact self-extinguishing ABS plastic  
 It is completed with wearproof cable input

### Diffuser:

Polycarbonate with UV stabilizer additives  
 Mounted to the body of the lamp on the latches

### Specifications:

Index of color transmission Ra > 80  
 Temperature range from -40 °C to + 45 °C  
 Network frequency 50Hz ± 10%  
 LED life 50,000 hours  
 3 year warranty  
 Luminous flux Kn <1%



**IP65 Strong**  
1242×90×68mm

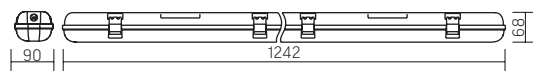

**DALI**

AC176-264V  
PF ≥ 0,97

Article	Power	Light temperature	Luminous flux*	Matt Diffuser	Clear Diffuser
V1-I0-70210-03D01-6503665	36W	3000K	4000lm		
V1-I0-70210-03D01-6503640	36W	4000K	4200lm		
V1-I0-70210-03D01-6503650	36W	5000K	4200lm		
V1-I0-70210-03D01-6503665	36W	6500K	4400lm		
V1-I0-70210-03D01-6505440	54W	4000K	6300lm		
V1-I0-70210-03D01-6505450	54W	5000K	6300lm		
V1-I0-70210-03D01-6505465	54W	6500K	6600lm		

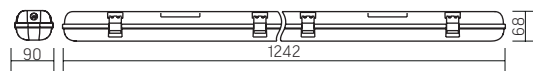

**SENSOR**

AC176-264V  
PF ≥ 0,97

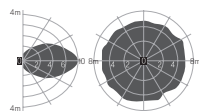

Article	Power	Light temperature	Luminous flux*	Matt Diffuser	Clear Diffuser
V1-I0-70210-03S00-6501840	18W	4000K	2100lm		
V1-I0-70210-03S00-6501850	18W	5000K	2100lm		
V1-I0-70210-03S00-6501865	18W	6500K	2200lm		
V1-I0-70210-03S00-6503640	36W	4000K	4200lm		
V1-I0-70210-03S00-6503650	36W	5000K	4200lm		
V1-I0-70210-03S00-6503665	36W	6500K	4400lm		
V1-I0-70210-03S00-6505440	54W	4000K	6300lm		
V1-I0-70210-03S00-6505450	54W	5000K	6300lm		
V1-I0-70210-03S00-6505465	54W	6500K	6600lm		

**IP65 Strong**  
1242×90×68mm

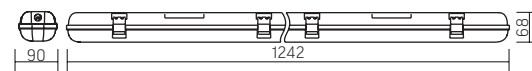

**A**

**Autonomous emergency lamp constant action**

Emergency power supply unit battery for 1 hour of autonomous operation, charge indicator, "Test" button in the set (see description on page 266)

**Conformity:**

Standard IEC 60598-2-22-2012 «Luminaires, Part 2-22. Private requirements. Luminaires for emergency lighting »  
SP 52. 13330. 2011 "Natural and artificial lighting" (updated edition of SNiP 23.05-95)

Article	Power	Light temperature	Luminous flux*
V1-I0-70210-03A00-6501840	18W	4000K	2100lm
V1-I0-70210-03A00-6501850	18W	5000K	2100lm
V1-I0-70210-03A00-6501865	18W	6500K	2200lm
V1-I0-70210-03A00-6503640	36W	4000K	4200lm
V1-I0-70210-03A00-6503650	36W	5000K	4200lm
V1-I0-70210-03A00-6503665	36W	6500K	4400lm
V1-I0-70210-03A00-6505440	54W	4000K	6300lm
V1-I0-70210-03A00-6505450	54W	5000K	6300lm
V1-I0-70210-03A00-6505465	54W	6500K	6600lm

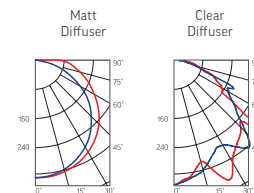





## IP65 Strong

674×90×68mm

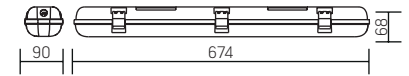

AC176-264V  
 Package size of the lamp:  
 706×98×56mm  
 PF ≥ 0,97



Article	Power	Light temperature	Luminous flux*	Matt Diffuser	Clear Diffuser
V1-I0-70215-03000-6501840	18W	4000K	2100lm		
V1-I0-70215-03000-6501850	18W	5000K	2100lm		
V1-I0-70215-03000-6501865	18W	6500K	2200lm		
V1-I0-70215-03000-6502740	27W	4000K	3150lm		
V1-I0-70215-03000-6502750	27W	5000K	3150lm		
V1-I0-70215-03000-6502765	27W	6500K	3300lm		

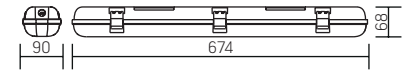

DC24-36V  
 PF ≥ 0,97



Article	Power	Light temperature	Luminous flux*	Matt Diffuser	Clear Diffuser
V1-I0-70215-03N00-6501840	18W	4000K	2100lm		
V1-I0-70215-03N00-6501850	18W	5000K	2100lm		
V1-I0-70215-03N00-6501865	18W	6500K	2200lm		

### Installation:

Mount directly on a horizontal or vertical surface  
 Can be mounted on hangers

### Case:

High impact self-extinguishing ABS plastic  
 It is completed with wearproof cable input

### Diffuser:

Polycarbonate with UV stabilizer additives  
 Mounted to the body of the lamp on the latches

### Specifications:

- Index of color transmission Ra > 80
- Temperature range from -40 °C to + 45 °C
- Network frequency 50Hz ± 10%
- LED life 50,000 hours
- 3 year warranty
- Luminous flux Kn <1%



**IP65 Strong**  
674×90×68mm

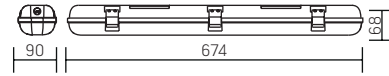

**DALI**

AC176-264V  
PF ≥ 0,97

NEW MODEL

Article	Power	Light temperature	Luminous flux*	Matt Diffuser	Clear Diffuser
V1-I0-70215-03D01-6501840	18W	4000K	2100lm		
V1-I0-70215-03D01-6501850	18W	5000K	2100lm		
V1-I0-70215-03D01-6501865	18W	6500K	2200lm		

**IP65 Strong**  
674×90×68mm

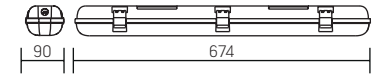

**Autonomous emergency lamp constant action**

NEW MODEL

Emergency power supply unit battery for 1 hour of autonomous operation, charge indicator, "Test" button in the set (see description on page 266)

**Conformity:**  
Standard IEC 60598-2-22:2012 «Luminaires. Part 2-22. Private requirements. Luminaires for emergency lighting »  
SP 52. 13330. 2011 "Natural and artificial lighting" (updated edition of SNiP 23.05-95)

Article	Power	Light temperature	Luminous flux*
V1-I0-70215-03A00-6501840	18W	4000K	2100lm
V1-I0-70215-03A00-6501850	18W	5000K	2100lm
V1-I0-70215-03A00-6501865	18W	6500K	2200lm

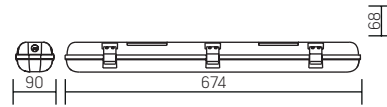
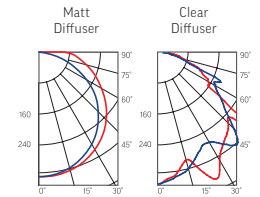

AC176-264V  
PF ≥ 0,97

NEW MODEL

metal

Article	Power	Light temperature	Luminous flux*	Matt Diffuser	Clear Diffuser
V1-I0-70215-03S00-6501840	18W	4000K	2100lm		
V1-I0-70215-03S00-6501850	18W	5000K	2100lm		
V1-I0-70215-03S00-6501865	18W	6500K	2200lm		

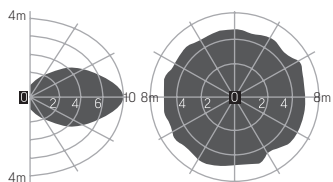

\* Luminous flux is specified without Diffuser



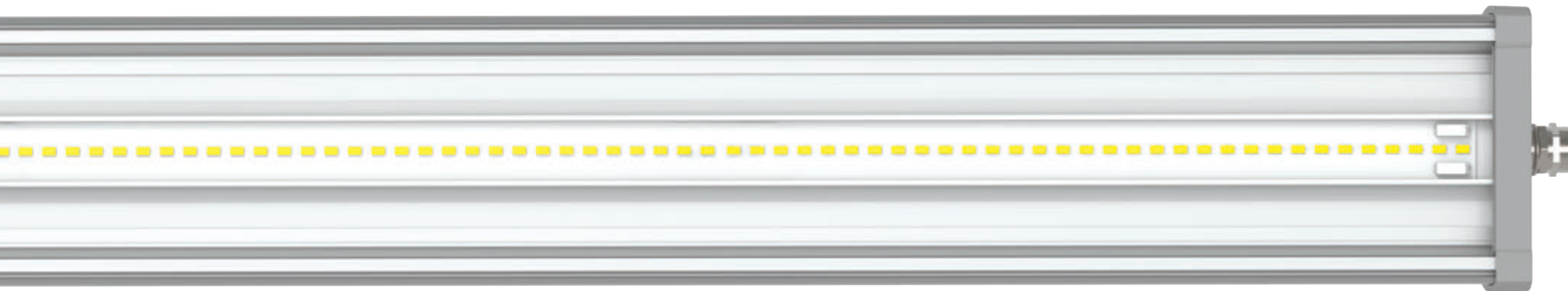

## IRON 2.0

Linear lamp  
Aluminum extrusion body IP66/67



Dimensions

**28W** **36W** **48W**



906 mm

**36W** **44W** **62W**



1190 mm

**44W** **56W** **80W**



1475 mm

Version

**DALI**

DALI protocol dimming



Emergency version

Optics

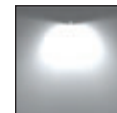

89°x115°



58°x121°

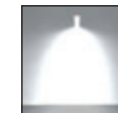

58°x121°

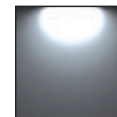

Clear Diffuser



92°x35°

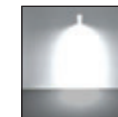

92°x35°



Opal Diffuser



Asymmetry



Asymmetry



Oblique light



Narrow asymmetry



Narrow asymmetry

Light temperature

4000K  
Neutral white





**Iron 2.0, 0.9m**  
906×109×66mm

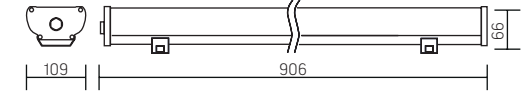

**Iron 2.0 Acryl**

AC176-264V  
Package size of the lamp:  
965×113×70mm  
PF ≥ 0,97



metal

Article	Power	Light temperature	Luminous flux
V1-IA-70157-03000-6702840	28W	4000K	3700lm
V1-IA-70157-03000-6703640	36W	4000K	4600lm
V1-IA-70157-03000-6704840	48W	4000K	6000lm

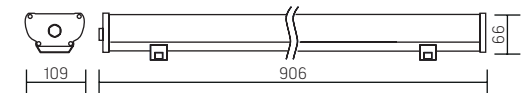
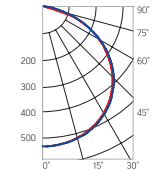

**Iron 2.0 Opal**

AC176-264V  
Package size of the lamp:  
965×113×70mm  
PF ≥ 0,97

metal

Article	Power	Light temperature	Luminous flux
V1-I0-70157-03G02-6702840	28W	4000K	2800lm
V1-I0-70157-03G02-6703640	36W	4000K	3700lm
V1-I0-70157-03G02-6704840	48W	4000K	4700lm

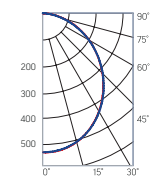

**Installation:**

It is mounted both on a flat surface and on hangers  
Easy installation and connection due to the wires removed from the luminaire

**Case:**

Aluminum anodized body  
Diffuser transparent PMMA (acrylic) in the version of Iron 2.0 Acryl  
Opal diffuser in the version of Iron 2.0 Opal

**Application:**

For lighting livestock and poultry complexes  
Industrial premises with high illumination requirements

**Specifications:**

Index of color transmission Ra > 80  
Temperature range from -40 ° C to + 45 ° C  
LED life 50,000 hours  
3 year warranty  
Luminous flux Kn≤1%



### Iron 2.0, 1.2m

1190×109×66mm

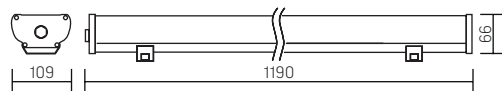

#### Iron 2.0 Acryl

AC176-264V  
Package size of the lamp:  
1293×117×70mm  
PF ≥ 0,97



○ metal

Article	Power	Light temperature	Luminous flux
V1-IA-70156-03000-6703640	36W	4000K	4900lm
V1-IA-70156-03000-6704440	44W	4000K	6200lm
V1-IA-70156-03000-6706240	62W	4000K	8200lm

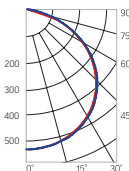

### Iron 2.0, 1.5m

1475×109×66mm

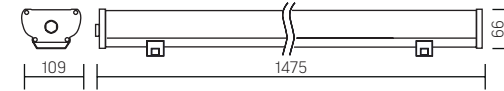

#### Iron 2.0 Acryl

AC176-264V  
Package size of the lamp:  
1541×119×70mm  
PF ≥ 0,97



○ metal

Article	Power	Light temperature	Luminous flux
V1-IA-70155-03000-6704440	44W	4000K	6300lm
V1-IA-70155-03000-6705640	56W	4000K	8200lm
V1-IA-70155-03000-6708040	80W	4000K	10300lm

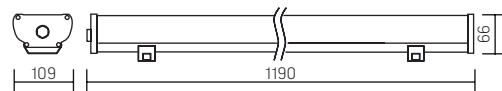
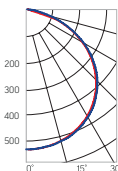

#### Iron 2.0 Opal

AC176-264V  
Package size of the lamp:  
1293×117×70mm  
PF ≥ 0,97

○ metal

Article	Power	Light temperature	Luminous flux
V1-I0-70156-03G02-6703640	36W	4000K	3700lm
V1-I0-70156-03G02-6704440	44W	4000K	4800lm
V1-I0-70156-03G02-6706240	62W	4000K	6300lm

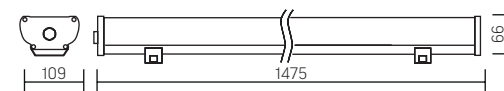
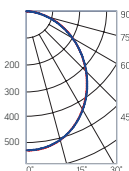

#### Iron 2.0 Opal

AC176-264V  
Package size of the lamp:  
1541×119×70mm  
PF ≥ 0,97

○ metal

Article	Power	Light temperature	Luminous flux
V1-I0-70155-03G02-6704440	44W	4000K	5100lm
V1-I0-70155-03G02-6705640	56W	4000K	6700lm
V1-I0-70155-03G02-6708040	80W	4000K	8300lm

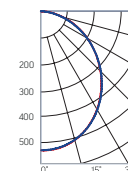



## Iron 2.0 LENS, 0.9m

906×109×66mm

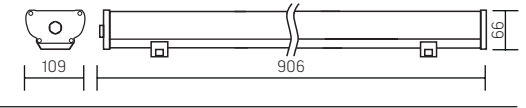

AC176-264V  
 Package size:  
 965×113×70mm  
 PF ≥ 0,97



Article	Power	Light temperature	Luminous flux
V1-IA-70157-03L12-6702840	28W	4000K	3600lm
V1-IA-70157-03L12-6703640	36W	4000K	4400lm
V1-IA-70157-03L12-6704840	48W	4000K	5800lm

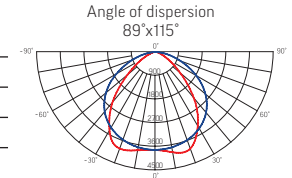

Article	Power	Light temperature	Luminous flux
V1-IA-70157-03L13-6702840	28W	4000K	3400lm
V1-IA-70157-03L13-6703640	36W	4000K	4300lm
V1-IA-70157-03L13-6704840	48W	4000K	5500lm

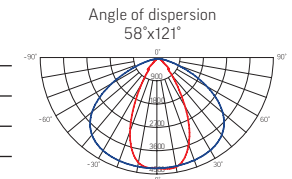

Article	Power	Light temperature	Luminous flux
V1-IA-70157-03L14-6702840	28W	4000K	3400lm
V1-IA-70157-03L14-6703640	36W	4000K	4200lm
V1-IA-70157-03L14-6704840	48W	4000K	5500lm

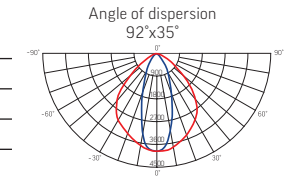

Article	Power	Light temperature	Luminous flux
V1-IA-70157-03L15-6702840	28W	4000K	3200lm
V1-IA-70157-03L15-6703640	36W	4000K	4100lm
V1-IA-70157-03L15-6704840	48W	4000K	5500lm

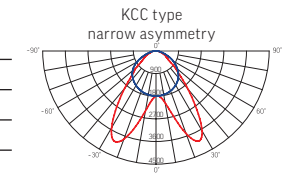

Article	Power	Light temperature	Luminous flux
V1-IA-70157-03L16-6702840	28W	4000K	3200lm
V1-IA-70157-03L16-6703640	36W	4000K	4100lm
V1-IA-70157-03L16-6704840	48W	4000K	5400lm

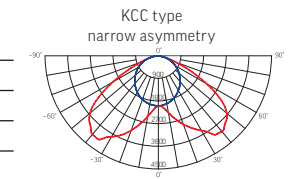

Article	Power	Light temperature	Luminous flux
V1-IA-70157-03L17-6702840	28W	4000K	3500lm
V1-IA-70157-03L17-6703640	36W	4000K	4400lm
V1-IA-70157-03L17-6704840	48W	4000K	5900lm

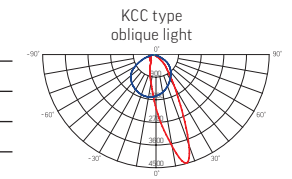

### Installation:

It is mounted both on a flat surface and on suspensions  
 Easy installation and connection due to the wires removed  
 from the luminaire

### Case:

Aluminum anodized body  
 Diffuser transparent PMMA (acrylic)

### Application:

For lighting warehouse and industrial premises. Shopping  
 facilities, including network retail class A.

### Specifications:

Index of color transmission Ra > 80  
 Temperature range from -40 °C to + 45 °C  
 LED life 50,000 hours  
 3 year warranty  
 Luminous flux Kn≤1%

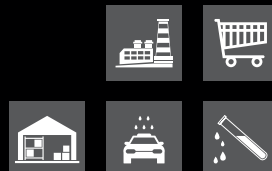

## Iron 2.0 LENS, 1.2m

1190×109×66mm

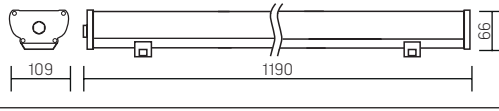

AC176-264V  
Package size:  
1293×117×70mm  
PF ≥ 0,97



Article	Power	Light temperature	Luminous flux	Angle of dispersion 89°x115°
V1-IA-70156-03L12-6703640	36W	4000K	4700lm	
V1-IA-70156-03L12-6704440	44W	4000K	5900lm	
V1-IA-70156-03L12-6706240	62W	4000K	7800lm	

Article	Power	Light temperature	Luminous flux	Angle of dispersion 58°x121°
V1-IA-70156-03L13-6703640	36W	4000K	4700lm	
V1-IA-70156-03L13-6704440	44W	4000K	6000lm	
V1-IA-70156-03L13-6706240	62W	4000K	8000lm	

Article	Power	Light temperature	Luminous flux	Angle of dispersion 92°x35°
V1-IA-70156-03L14-6703640	36W	4000K	4700lm	
V1-IA-70156-03L14-6704440	44W	4000K	5900lm	
V1-IA-70156-03L14-6706240	62W	4000K	7700lm	

Article	Power	Light temperature	Luminous flux	KCC type narrow asymmetry
V1-IA-70156-03L15-6703640	36W	4000K	4500lm	
V1-IA-70156-03L15-6704440	44W	4000K	5600lm	
V1-IA-70156-03L15-6706240	62W	4000K	7400lm	

Article	Power	Light temperature	Luminous flux	KCC type narrow asymmetry
V1-IA-70156-03L16-6703640	36W	4000K	4400lm	
V1-IA-70156-03L16-6704440	44W	4000K	5500lm	
V1-IA-70156-03L16-6706240	62W	4000K	7300lm	

Article	Power	Light temperature	Luminous flux	KCC type oblique light
V1-IA-70156-03L17-6703640	36W	4000K	4300lm	
V1-IA-70156-03L17-6704440	44W	4000K	5600lm	
V1-IA-70156-03L17-6706240	62W	4000K	7300lm	

## Iron 2.0 LENS, 1.5m

1475×109×66mm

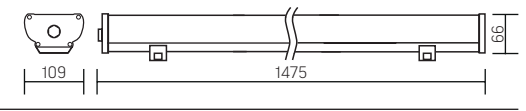

AC176-264V  
Package size:  
1541×119×70mm  
PF ≥ 0,97



Article	Power	Light temperature	Luminous flux	Angle of dispersion 89°x115°
V1-IA-70155-03L12-6704440	44W	4000K	5800lm	
V1-IA-70155-03L12-6705640	56W	4000K	7400lm	
V1-IA-70155-03L12-6708040	80W	4000K	9700lm	

Article	Power	Light temperature	Luminous flux	Angle of dispersion 58°x121°
V1-IA-70155-03L13-6704440	44W	4000K	5900lm	
V1-IA-70155-03L13-6705640	56W	4000K	7500lm	
V1-IA-70155-03L13-6708040	80W	4000K	9800lm	

Article	Power	Light temperature	Luminous flux	Angle of dispersion 92°x35°
V1-IA-70155-03L14-6704440	44W	4000K	5800lm	
V1-IA-70155-03L14-6705640	56W	4000K	7300lm	
V1-IA-70155-03L14-6708040	80W	4000K	9600lm	

Article	Power	Light temperature	Luminous flux	KCC type narrow asymmetry
V1-IA-70155-03L15-6704440	44W	4000K	5500lm	
V1-IA-70155-03L15-6705640	56W	4000K	7000lm	
V1-IA-70155-03L15-6708040	80W	4000K	9000lm	

Article	Power	Light temperature	Luminous flux	KCC type narrow asymmetry
V1-IA-70155-03L16-6704440	44W	4000K	5500lm	
V1-IA-70155-03L16-6705640	56W	4000K	6900lm	
V1-IA-70155-03L16-6708040	80W	4000K	9000lm	

Article	Power	Light temperature	Luminous flux	KCC type oblique light
V1-IA-70155-03L17-6704440	44W	4000K	5600lm	
V1-IA-70155-03L17-6705640	56W	4000K	7400lm	
V1-IA-70155-03L17-6708040	80W	4000K	9600lm	







# IRON

Linear lamp  
Aluminum extrusion body  
IP66/67



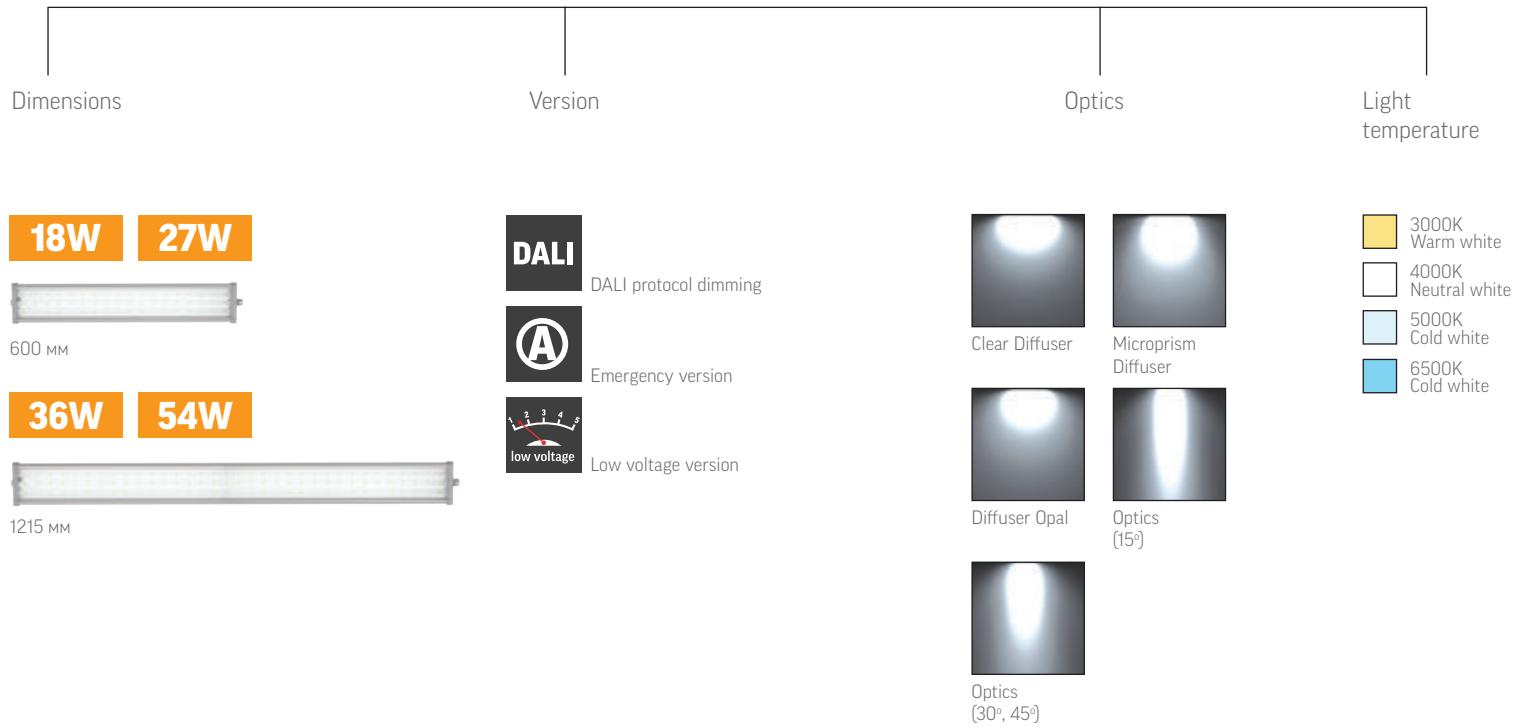

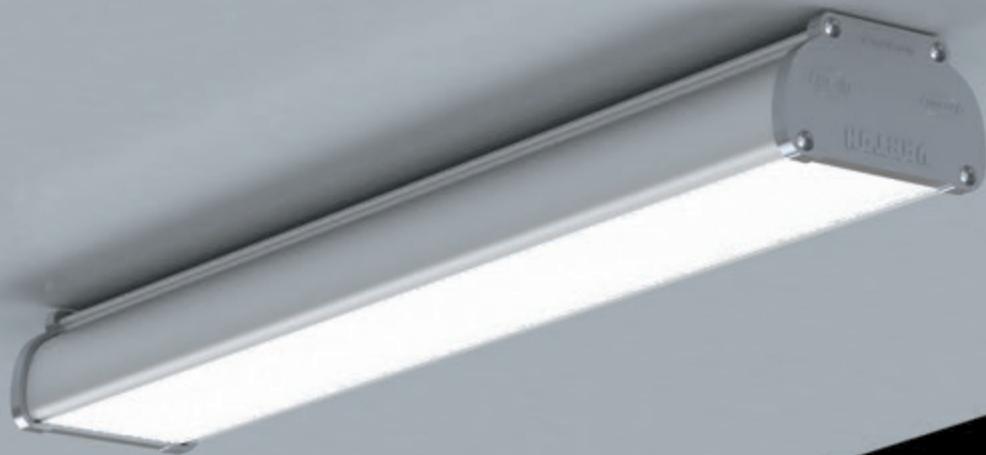

**Iron**  
1215×109×66mm

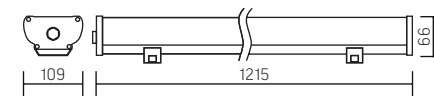

AC176-264V  
Package size of the lamp:  
1299×117×72mm  
PF ≥ 0,97



○ metal

Article	Power	Light temperature	Luminous flux
V1-I0-70072-03000-6703630	36W	3000K	2900lm
V1-I0-70072-03000-6703640	36W	4000K	3000lm
V1-I0-70072-03000-6703650	36W	5000K	3000lm
V1-I0-70072-03000-6703665	36W	6500K	3200lm
V1-I0-70072-03000-6705440	54W	4000K	4700lm
V1-I0-70072-03000-6705450	54W	5000K	4700lm
V1-I0-70072-03000-6705465	54W	6500K	5000lm

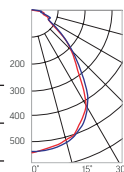

**Installation:**

It is mounted both on a flat surface, and on suspensions  
Easy installation and connection due to the wires removed from the lamp housing

**Case:**

Aluminum anodized body  
Diffuser made of polycarbonate with increased impact resistance  
Special silicone pads to ensure compliance with IP67 protection class

**Application:**

Rooms with increased requirements for the reliability of lamps,  
street lighting

**Specifications:**

Index of color transmission Ra > 80  
Temperature range from -40 °C to + 45 °C  
LED life 50,000 hours  
3 year warranty  
Luminous flux Kn ≤ 1%



## Iron

1215×109×66mm

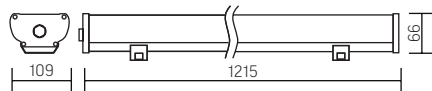

### Autonomous emergency lamp constant action

Emergency power supply unit, battery for 1 hour of autonomous operation, charge indicator, "Test" button included (see description on page 266)

### Conformity:

GOST IEC 60598-2-22-2012 – Luminaires. Part 2-22. Private requirements. Luminaires for emergency lighting » SP 52. 13330. 2011 "Natural and artificial lighting" (updated edition of SNiP 23.05-95)

Article	Power	Light temperature	Luminous flux
V1-10-70072-03A00-6703640	36W	4000K	3000lm
V1-10-70072-03A00-6703650	36W	5000K	3000lm
V1-10-70072-03A00-6703665	36W	6500K	3200lm
V1-10-70072-03A00-6705440	54W	4000K	4700lm
V1-10-70072-03A00-6705450	54W	5000K	4700lm
V1-10-70072-03A00-6705465	54W	6500K	5000lm

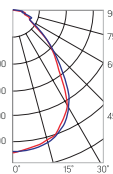

## Iron

600×109×66mm

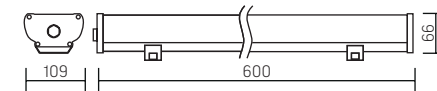

AC176-264V

Package size of the lamp:

646×117×72mm

PF ≥ 0,97



○ metal

Article	Power	Light temperature	Luminous flux
V1-10-70073-03000-6701830	18W	3000K	1300lm
V1-10-70073-03000-6701840	18W	4000K	1400lm
V1-10-70073-03000-6701850	18W	5000K	1400lm
V1-10-70073-03000-6701865	18W	6500K	1500lm
V1-10-70073-03000-6702740	27W	4000K	2400lm
V1-10-70073-03000-6702750	27W	5000K	2400lm
V1-10-70073-03000-6702765	27W	6500K	2500lm

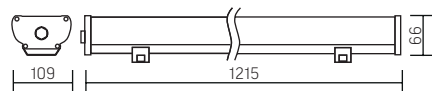
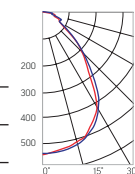

## DALI

Article	Power	Light temperature	Luminous flux
V1-10-70072-03D01-6703640	36W	4000K	3000lm
V1-10-70072-03D01-6703650	36W	5000K	3000lm
V1-10-70072-03D01-6703665	36W	6500K	3200lm
V1-10-70072-03D01-6705440	54W	4000K	4700lm
V1-10-70072-03D01-6705450	54W	5000K	4700lm
V1-10-70072-03D01-6705465	54W	6500K	5000lm

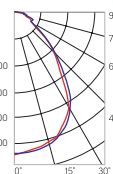



## Iron Lens 15°

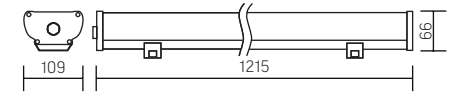

1215×109×66mm  
 AC176-264V  
 Package size of the lamp:  
 1293×117×72mm  
 PF ≥ 0,97



Article	Power	Light temperature	Luminous flux
V1-I0-70072-03L01-6701840	18W	4000K	2100lm
V1-I0-70072-03L01-6701865	18W	6500K	2200lm
V1-I0-70072-03L01-6703640	36W	4000K	3700lm
V1-I0-70072-03L01-6703665	36W	6500K	3800lm
V1-I0-70072-03L01-6705440	54W	4000K	5800lm
V1-I0-70072-03L01-6705465	54W	6500K	5900lm

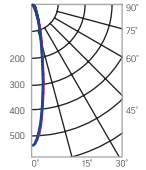

**Installation:**  
 It is mounted both on a flat surface, and on suspensions  
 Easy installation and connection due to the wires removed from the lamp housing

**Case:**  
 Aluminum anodized body  
 Diffuser made of acrylic with increased impact resistance  
 Special silicone pads to ensure compliance with IP67 protection class

**Application:**  
 Rooms with increased requirements for the reliability of lamps, street lighting

**Specifications:**  
 Index of color transmission Ra > 80  
 Temperature range from -40 °C to + 45 °C  
 LED life 50,000 hours  
 3 year warranty  
 Luminous flux ≤ 1%

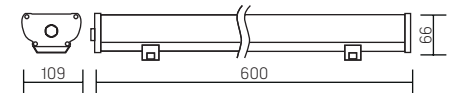

600×109×66mm  
 AC176-264V  
 Package size of the lamp:  
 646×117×72mm  
 PF ≥ 0,97



Article	Power	Light temperature	Luminous flux
V1-I0-70073-03L01-6701840	18W	4000K	2100lm
V1-I0-70073-03L01-6701865	18W	6500K	2200lm
V1-I0-70073-03L01-6702740	27W	4000K	2700lm
V1-I0-70073-03L01-6702765	27W	6500K	2800lm

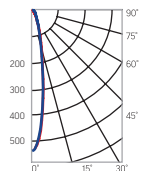

## Iron Lens 30°

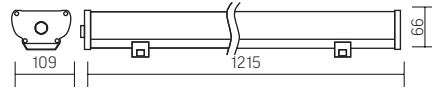

1215×109×66mm  
AC176-264V  
Package size of the lamp:  
1293×117×72mm  
PF ≥ 0,97



Article	Power	Light temperature	Luminous flux
V1-I0-70072-03L02-6703640	36W	4000K	3700lm
V1-I0-70072-03L02-6703665	36W	6500K	3800lm
V1-I0-70072-03L02-6705440	54W	4000K	5400lm
V1-I0-70072-03L02-6705465	54W	6500K	5600lm

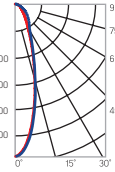

## Iron Lens 45°

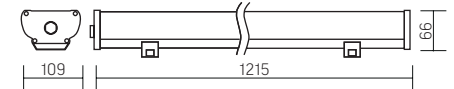

1215×109×66mm  
AC176-264V  
Package size of the lamp:  
1293×117×72mm  
PF ≥ 0,97



Article	Power	Light temperature	Luminous flux
V1-I0-70072-03L03-6703640	36W	4000K	3700lm
V1-I0-70072-03L03-6703665	36W	6500K	3800lm
V1-I0-70072-03L03-6705440	54W	4000K	5400lm
V1-I0-70072-03L03-6705465	54W	6500K	5600lm

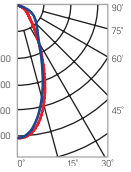

600×109×66mm  
AC176-264V  
Package size of the lamp:  
646×117×72mm  
PF ≥ 0,97



Article	Power	Light temperature	Luminous flux
V1-I0-70073-03L02-6701840	18W	4000K	2100lm
V1-I0-70073-03L02-6701865	18W	6500K	2200lm
V1-I0-70073-03L02-6702740	27W	4000K	2700lm
V1-I0-70073-03L02-6702765	27W	6500K	2800lm

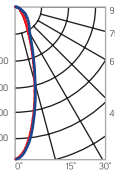

600×109×66mm  
AC176-264V  
Package size of the lamp:  
646×117×72mm  
PF ≥ 0,97



Article	Power	Light temperature	Luminous flux
V1-I0-70073-03L03-6701840	18W	4000K	2100lm
V1-I0-70073-03L03-6701865	18W	6500K	2200lm
V1-I0-70073-03L03-6702740	27W	4000K	2700lm
V1-I0-70073-03L03-6702765	27W	6500K	2800lm

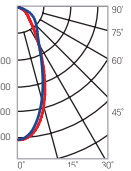



## Iron Opal

1215×109×66mm

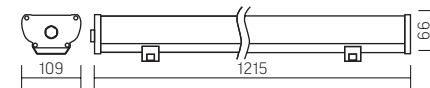

AC176-264V  
 Package size of the lamp:  
 1293×117×72mm  
 Pf≥0,97



○ metal

Article	Power	Light temperature	Luminous flux
V1-IA-70072-03G02-6703640	36W	4000K	3400lm
V1-IA-70072-03G02-6703650	36W	5000K	3400lm
V1-IA-70072-03G02-6703665	36W	6500K	3500lm
V1-IA-70072-03G02-6705440	54W	4000K	5000lm
V1-IA-70072-03G02-6705450	54W	5000K	5000lm
V1-IA-70072-03G02-6705465	54W	6500K	5200lm

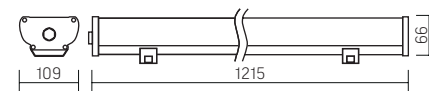
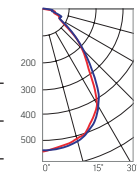

### **A** Autonomous emergency lamp constant action

Emergency power supply unit, battery for 1 hour of autonomous operation, charge indicator, "Test" button included (see description on page 266)

Article	Power	Light temperature	Luminous flux
V1-IA-70072-03X13-6703640	36W	4000K	3400lm
V1-IA-70072-03X13-6703650	36W	5000K	3400lm
V1-IA-70072-03X13-6703665	36W	6500K	3500lm
V1-IA-70072-03X13-6705440	54W	4000K	5000lm
V1-IA-70072-03X13-6705450	54W	5000K	5000lm
V1-IA-70072-03X13-6705465	54W	6500K	5200lm

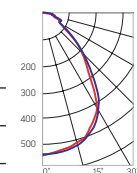

**Conformity:**  
 GOST IEC 60598-2-22:2012 – Luminaires. Part 2-22. Private requirements. Luminaires for emergency lighting » SP 52. 13330. 2011 "Natural and artificial lighting" (updated edition of SNiP 23.05- 95)

### Installation:

It is mounted both on a flat surface, and on suspensions  
 Convenient connection of the lamp, due to the presence of an external power cord

### Case:

Aluminum anodized body  
 Diffuser made of opal acrylic with high impact resistance and with high resistance to chemical and physical effects  
 Special silicone pads to ensure compliance with IP67 protection class

### Application:

Premises with high requirements for reliability of luminaires

### Specifications:

Index of color transmission Ra > 80  
 Temperature range from -40 ° C to + 45 ° C  
 LED life 50,000 hours  
 3 year warranty  
 Luminous flux Kn≤ 1%



Mounts for LED luminaires of the Iron, Iron 2.0 and Iron Lens series.

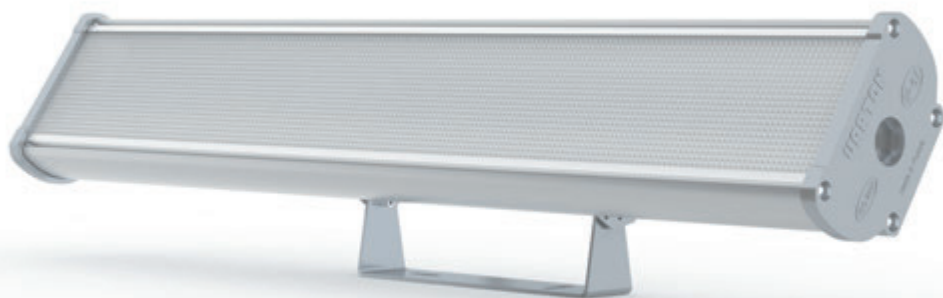

V4-IO-70.0087.IRO-0001  
Swivel mount (180 ° angle) for Iron luminaires Iron  
192×45×80mm

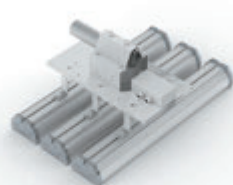

V4-IO-70.0003.IRO-0001  
Console for 3 pcs. lamps 325×120×300mm

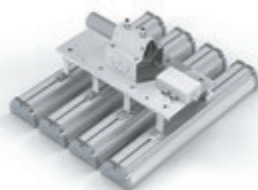

V4-IO-70.0003.IRO-0002  
Console for 4 pcs. lamps 450×120×300mm



V4-IO-70.0003.IRO-0004  
Suspension mount on eye-nuts, a set of two pieces

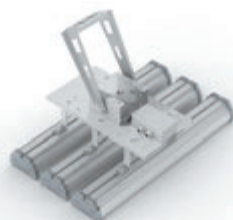

V4-IO-70.0002.IRO-0002  
Swivel mount for 3 pcs. lamps 325×276×300mm



V4-IO-70.0002.IRO-0003  
Swivel mount for 4 pcs. lamps 450×276×300mm

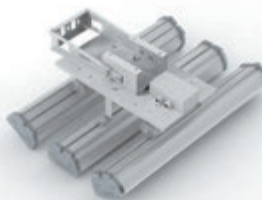

Installation of a single mount on a group mount to adjust the angle of the lamp

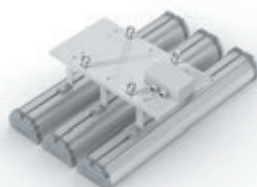

V4-IO-70.0004.IRO-0001  
Swivel mount for 3 pcs. lamps 325×120×300mm

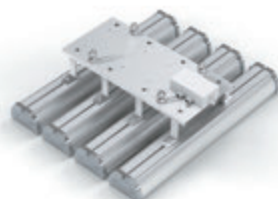

V4-IO-70.0003.IRO-0003  
Swivel mount for 4 pcs. lamps 450×120×300mm

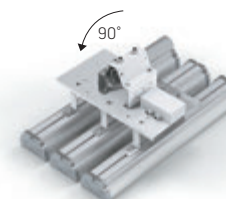
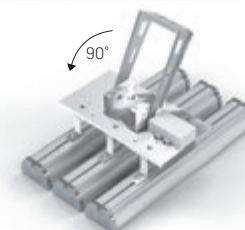

The possibility of turning the swivel and console mounts 90 ° for easy installation

**Case:** Galvanized steel  
**Mounting:** Conveniently connecting luminaires using WAGO terminals in wiring boxes  
Swivel mount is mounted on a flat surface of the ceiling or wall.  
**Angle of rotation** 180 °, in increments of 15 °.  
Allows you to adjust the angle of illumination of lamps in the premises of storage areas, industrial plants or in the open air  
Installation on console with diameter from 40 mm to 50 mm





# OLYMP 2.0

Aluminum extrusion body  
Swivel mounting bracket  
IP65



Installation



On a flat surface

Available capacities

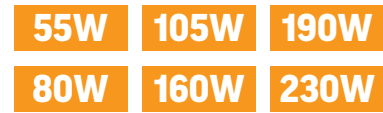

Version



Optics



12° 30° 60°



90° 30°x110° 120°

Light temperature



NEW  
MODEL



**Installation:**

It is mounted on walls, ceiling and floor with the ability to adjust the angle of inclination within 180°

**Case:**

Aluminum anodized body

Secondary optics:

To protect the LEDs used secondary optics without the use of glass, which allows high energy efficiency

Secondary optics made of acrylic resistant to physical and chemical influences

**Specifications:**

Ra color index > 75

Temperature range from -40 °C to + 45 °C

AC100-305V, 47-63 Hz, DC 142-431V

Network frequency 50Hz ± 10%

LED life 50,000 hours

3 year warranty

Luminous flux  $K_n \leq 1\%$



**Olymp 2.0**

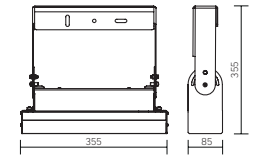

Angle of rotation – 180°

Lamp Size:  
355×85×325mm  
PF ≥ 0,97



○ metal

**DALI**

Article	Power	Power Light temperature	Luminous flux	Angle of dispersion
V1-I0-70549-04L10-6505550	55W	5000K	7700lm	12°
V1-I0-70549-04L02-6505550	55W	5000K	7700lm	30°
V1-I0-70549-04L07-6505550	55W	5000K	7700lm	60°
V1-I0-70549-04L06-6505550	55W	5000K	7700lm	90°
V1-I0-70549-04L08-6505550	55W	5000K	7700lm	30°x110°
V1-I0-70549-04L10-65065540	55W	4000K	7700lm	12°
V1-I0-70549-04L02-65065540	55W	4000K	7700lm	30°
V1-I0-70549-04L07-65065540	55W	4000K	7700lm	60°
V1-I0-70549-04L06-65065540	55W	4000K	7700lm	90°
V1-I0-70549-04L08-65065540	55W	4000K	7700lm	30°x110°

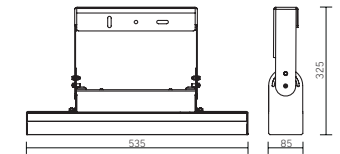
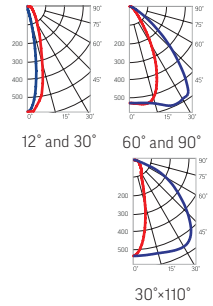

Angle of rotation – 180°

Lamp Size:  
535×85×325mm  
PF ≥ 0,97

○ metal

Article	Power	Power Light temperature	Luminous flux	Angle of dispersion
V1-I0-70550-04L10-6508050	80W	5000K	11200lm	12°
V1-I0-70550-04L02-6508050	80W	5000K	11200lm	30°
V1-I0-70550-04L07-6508050	80W	5000K	11200lm	60°
V1-I0-70550-04L06-6508050	80W	5000K	11200lm	90°
V1-I0-70550-04L08-6508050	80W	5000K	11200lm	30°x110°
V1-I0-70550-04L10-6508040	80W	4000K	11200lm	12°
V1-I0-70550-04L02-6508040	80W	4000K	11200lm	30°
V1-I0-70550-04L07-6508040	80W	4000K	11200lm	60°
V1-I0-70550-04L06-6508040	80W	4000K	11200lm	90°
V1-I0-70550-04L08-6508040	80W	4000K	11200lm	30°x110°

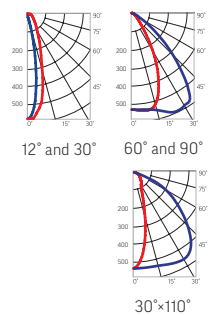

# Olymp 2.0

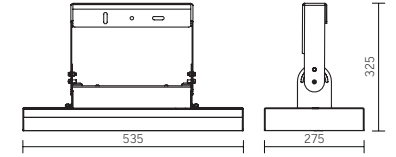
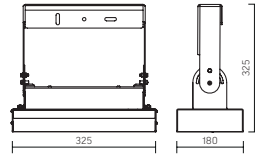

Angle of rotation – 180°  
Lamp Size:  
355×180×325mm  
PF ≥ 0,97  
○ metal

Article	Power	Power Light temperature	Luminous flux	Angle of dispersion
V1-10-70551-04L10-6510550	105W	5000K	14700lm	12°
V1-10-70551-04L02-6510550	105W	5000K	14700lm	30°
V1-10-70551-04L07-6510550	105W	5000K	14700lm	60°
V1-10-70551-04L06-6510550	105W	5000K	14700lm	90°
V1-10-70551-04L08-6510550	105W	5000K	14700lm	30°x110°
V1-10-70551-04L10-6510540	105W	4000K	14700lm	12°
V1-10-70551-04L02-6510540	105W	4000K	14700lm	30°
V1-10-70551-04L07-6510540	105W	4000K	14700lm	60°
V1-10-70551-04L06-6510540	105W	4000K	14700lm	90°
V1-10-70551-04L08-6510540	105W	4000K	14700lm	30°x110°

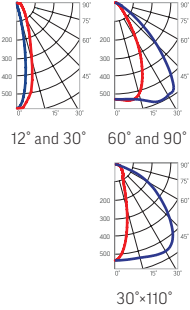

Angle of rotation – 180°  
Lamp Size:  
535×275×325mm  
PF ≥ 0,97  
○ metal

Article	Power	Power Light temperature	Luminous flux	Angle of dispersion
V1-10-70553-04L10-6519050	190W	5000K	26600lm	12°
V1-10-70553-04L02-6519050	190W	5000K	26600lm	30°
V1-10-70553-04L07-6519050	190W	5000K	26600lm	60°
V1-10-70553-04L06-6519050	190W	5000K	26600lm	90°
V1-10-70553-04L08-6519050	190W	5000K	26600lm	30°x110°
V1-10-70553-04L10-6519040	190W	4000K	26600lm	12°
V1-10-70553-04L02-6519040	190W	4000K	26600lm	30°
V1-10-70553-04L07-6519040	190W	4000K	26600lm	60°
V1-10-70553-04L06-6519040	190W	4000K	26600lm	90°
V1-10-70553-04L08-6519040	190W	4000K	26600lm	30°x110°
V1-10-70553-04L10-6523050	230W	5000K	32200lm	12°
V1-10-70553-04L02-6523050	230W	5000K	32200lm	30°
V1-10-70553-04L07-6523050	230W	5000K	32200lm	60°
V1-10-70553-04L06-6523050	230W	5000K	32200lm	90°
V1-10-70553-04L08-6523050	230W	5000K	32200lm	30°x110°
V1-10-70553-04L10-6523040	230W	4000K	32200lm	12°
V1-10-70553-04L02-6523040	230W	4000K	32200lm	30°
V1-10-70553-04L07-6523040	230W	4000K	32200lm	60°
V1-10-70553-04L06-6523040	230W	4000K	32200lm	90°
V1-10-70553-04L08-6523040	230W	4000K	32200lm	30°x110°
V1-10-70553-04L10-6531550	315W	5000K	44100lm	12°
V1-10-70553-04L02-6531550	315W	5000K	44100lm	30°
V1-10-70553-04L07-6531550	315W	5000K	44100lm	60°
V1-10-70553-04L06-6531550	315W	5000K	44100lm	90°
V1-10-70553-04L08-6531550	315W	5000K	44100lm	30°x110°
V1-10-70553-04L10-6531540	315W	4000K	44100lm	12°
V1-10-70553-04L02-6531540	315W	4000K	44100lm	30°
V1-10-70553-04L07-6531540	315W	4000K	44100lm	60°
V1-10-70553-04L06-6531540	315W	4000K	44100lm	90°
V1-10-70553-04L08-6531540	315W	4000K	44100lm	30°x110°

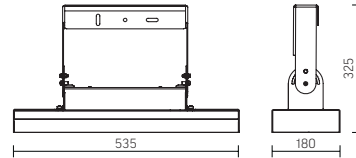
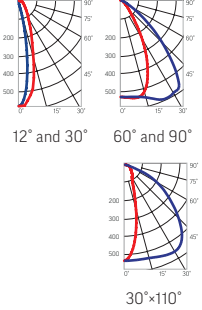

Angle of rotation – 180°  
Lamp Size:  
535×180×325mm  
PF ≥ 0,97  
○ metal

Article	Power	Power Light temperature	Luminous flux	Angle of dispersion
V1-10-70552-04L10-6516050	160W	5000K	22400lm	12°
V1-10-70552-04L02-6516050	160W	5000K	22400lm	30°
V1-10-70552-04L07-6516050	160W	5000K	22400lm	60°
V1-10-70552-04L06-6516050	160W	5000K	22400lm	90°
V1-10-70552-04L08-6516050	160W	5000K	22400lm	30°x110°
V1-10-70552-04L10-6516040	160W	4000K	22400lm	12°
V1-10-70552-04L02-6516040	160W	4000K	22400lm	30°
V1-10-70552-04L07-6516040	160W	4000K	22400lm	60°
V1-10-70552-04L06-6516040	160W	4000K	22400lm	90°
V1-10-70552-04L08-6516040	160W	4000K	22400lm	30°x110°

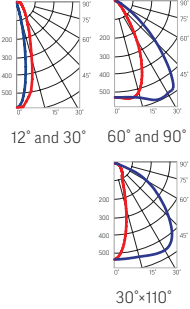

# OLYMP

Aluminum extrusion body  
Swivel mounting bracket  
IP65



### Installation



On a flat surface



On the console

### Available capacities



### Version



### Optics

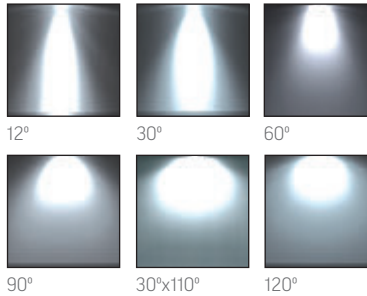

### Light temperature

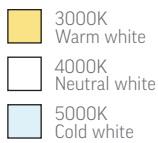

135  
lm/W



**Installation:**

Fastening on walls, ceiling and floor with the ability to adjust the angle of inclination within 180°

**Case:**

Aluminum anodized body

Secondary optics:

To protect the LEDs used secondary optics without the

use of glass, which allows high energy efficiency

Secondary optics made of acrylic, sustainable to

physical and chemical influences

**Specifications:**

Index of color transmission Ra > 75

Temperature range from -40 °C to + 45 °C

AC100-305V, 47-63 Hz, DC 142-431V

Network frequency 50Hz ± 10%

LED life 50,000 hours

3 year warranty

Luminous flux Kn ≤ 1%



**Olymp**

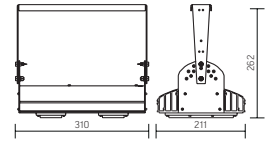

Angle of rotation – 180°

Lamp Size:

320×211×262mm

Package size of the lamp:

400×310×150mm

PF ≥ 0,97



○ metal

Article	Power	Light temperature	Luminous flux	Angle of dispersion
V1-I0-70076-04L10-6506050	55W	5000K	7425lm	12°
V1-I0-70076-04L02-6506050	55W	5000K	7425lm	30°
V1-I0-70076-04L07-6506050	55W	5000K	7425lm	60°
V1-I0-70076-04L06-6506050	55W	5000K	7425lm	90°
V1-I0-70076-04L08-6506050	55W	5000K	7425lm	30°x110°
V1-I0-70076-04L10-6506040	55W	4000K	7425lm	12°
V1-I0-70076-04L02-6506040	55W	4000K	7425lm	30°
V1-I0-70076-04L07-6506040	55W	4000K	7425lm	60°
V1-I0-70076-04L06-6506040	55W	4000K	7425lm	90°
V1-I0-70076-04L08-6506040	55W	4000K	7425lm	30°x110°
V1-I0-70076-04L10-6506030	55W	3000K	7150lm	12°
V1-I0-70076-04L02-6506030	55W	3000K	7150lm	30°
V1-I0-70076-04L07-6506030	55W	3000K	7150lm	60°
V1-I0-70076-04L06-6506030	55W	3000K	7150lm	90°
V1-I0-70076-04L08-6506030	55W	3000K	7150lm	30°x110°

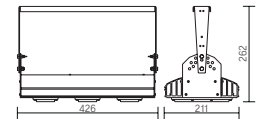
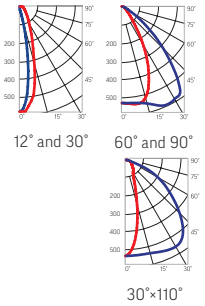

Angle of rotation – 180°

Lamp Size:

426×211×262mm

Package size of the lamp:

480×310×152mm

PF ≥ 0,97

○ metal

Article	Power	Light temperature	Luminous flux	Angle of dispersion
V1-I0-70077-04L10-6509050	80W	5000K	10800lm	12°
V1-I0-70077-04L02-6509050	80W	5000K	10800lm	30°
V1-I0-70077-04L07-6509050	80W	5000K	10800lm	60°
V1-I0-70077-04L06-6509050	80W	5000K	10800lm	90°
V1-I0-70077-04L08-6509050	80W	5000K	10800lm	30°x110°
V1-I0-70077-04L10-6509040	80W	4000K	10800lm	12°
V1-I0-70077-04L02-6509040	80W	4000K	10800lm	30°
V1-I0-70077-04L07-6509040	80W	4000K	10800lm	60°
V1-I0-70077-04L06-6509040	80W	4000K	10800lm	90°
V1-I0-70077-04L08-6509040	80W	4000K	10800lm	30°x110°
V1-I0-70077-04L10-6509030	80W	3000K	10400lm	12°
V1-I0-70077-04L02-6509030	80W	3000K	10400lm	30°
V1-I0-70077-04L07-6509030	80W	3000K	10400lm	60°
V1-I0-70077-04L06-6509030	80W	3000K	10400lm	90°
V1-I0-70077-04L08-6509030	80W	3000K	10400lm	30°x110°

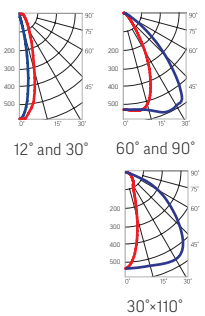

## Olymp

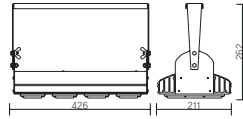

Angle of rotation – 180°  
Lamp Size:  
426×211×262mm  
Package size of the lamp:  
480×310×152mm  
PF ≥ 0,97

○ metal

Article	Power	Light temperature	Luminous flux	Angle of dispersion
V1-10-70077-04L10-6512050	110W	5000K	14850lm	12°
V1-10-70077-04L02-6512050	110W	5000K	14850lm	30°
V1-10-70077-04L07-6512050	110W	5000K	14850lm	60°
V1-10-70077-04L06-6512050	110W	5000K	14850lm	90°
V1-10-70077-04L08-6512050	110W	5000K	14850lm	30°x110°
V1-10-70077-04L10-6512040	110W	4000K	14850lm	12°
V1-10-70077-04L02-6512040	110W	4000K	14850lm	30°
V1-10-70077-04L07-6512040	110W	4000K	14850lm	60°
V1-10-70077-04L06-6512040	110W	4000K	14850lm	90°
V1-10-70077-04L08-6512040	110W	4000K	14850lm	30°x110°
V1-10-70077-04L10-6512030	110W	3000K	14850lm	12°
V1-10-70077-04L02-6512030	110W	3000K	14850lm	30°
V1-10-70077-04L07-6512030	110W	3000K	14850lm	60°
V1-10-70077-04L06-6512030	110W	3000K	14850lm	90°
V1-10-70077-04L08-6512030	110W	3000K	14850lm	30°x110°

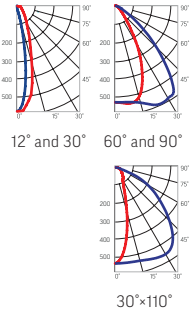

## Olymp

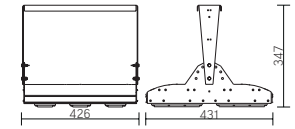
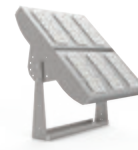

Angle of rotation – 180°  
Lamp Size:  
426×431×347mm  
Package size of the lamp:  
476×481×252mm  
PF ≥ 0,97

○ metal

Article	Power	Light temperature	Luminous flux	Angle of dispersion
V1-10-70096-04L10-6518050	160W	5000K	21600lm	12°
V1-10-70096-04L02-6518050	160W	5000K	21600lm	30°
V1-10-70096-04L07-6518050	160W	5000K	21600lm	60°
V1-10-70096-04L06-6518050	160W	5000K	21600lm	90°
V1-10-70096-04L08-6518050	160W	5000K	21600lm	30°x110°
V1-10-70096-04L10-6518040	160W	4000K	21600lm	12°
V1-10-70096-04L02-6518040	160W	4000K	21600lm	30°
V1-10-70096-04L07-6518040	160W	4000K	21600lm	60°
V1-10-70096-04L06-6518040	160W	4000K	21600lm	90°
V1-10-70096-04L08-6518040	160W	4000K	21600lm	30°x110°
V1-10-70096-04L10-6518030	160W	3000K	20800lm	12°
V1-10-70096-04L02-6518030	160W	3000K	20800lm	30°
V1-10-70096-04L07-6518030	160W	3000K	20800lm	60°
V1-10-70096-04L06-6518030	160W	3000K	20800lm	90°
V1-10-70096-04L08-6518030	160W	3000K	20800lm	30°x110°

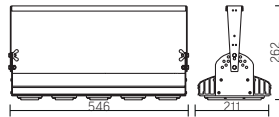
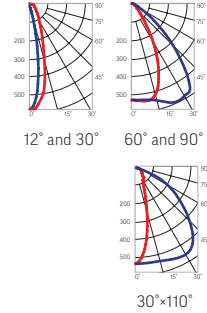

Angle of rotation – 180°  
Lamp Size:  
546×211×262mm  
Package size of the lamp:  
595×315×150mm  
PF ≥ 0,97

○ metal

Article	Power	Light temperature	Luminous flux	Angle of dispersion
V1-10-70078-04L10-6515050	135W	5000K	18225lm	12°
V1-10-70078-04L02-6515050	135W	5000K	18225lm	30°
V1-10-70078-04L07-6515050	135W	5000K	18225lm	60°
V1-10-70078-04L06-6515050	135W	5000K	18225lm	90°
V1-10-70078-04L08-6515050	135W	5000K	18225lm	30°x110°
V1-10-70078-04L10-6515040	135W	4000K	18225lm	12°
V1-10-70078-04L02-6515040	135W	4000K	18225lm	30°
V1-10-70078-04L07-6515040	135W	4000K	18225lm	60°
V1-10-70078-04L06-6515040	135W	4000K	18225lm	90°
V1-10-70078-04L08-6515040	135W	4000K	18225lm	30°x110°
V1-10-70078-04L10-65150430	135W	3000K	17550lm	12°
V1-10-70078-04L02-6515030	135W	3000K	17550lm	30°
V1-10-70078-04L07-6515030	135W	3000K	17550lm	60°
V1-10-70078-04L06-6515030	135W	3000K	17550lm	90°
V1-10-70078-04L08-6515030	135W	3000K	17550lm	30°x110°

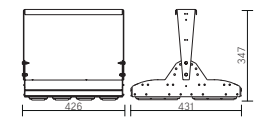
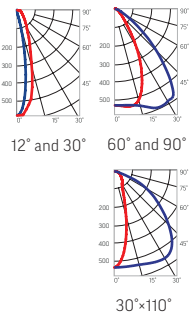

Angle of rotation – 180°  
Lamp Size:  
426×431×347mm  
Package size of the lamp:  
476×481×252mm  
PF ≥ 0,97

○ metal

Article	Power	Light temperature	Luminous flux	Angle of dispersion
V1-10-70096-04L10-6524050	215W	5000K	29025lm	12°
V1-10-70096-04L02-6524050	215W	5000K	29025lm	30°
V1-10-70096-04L07-6524050	215W	5000K	29025lm	60°
V1-10-70096-04L06-6524050	215W	5000K	29025lm	90°
V1-10-70096-04L08-6524050	215W	5000K	29025lm	30°x110°
V1-10-70096-04L10-6524040	215W	4000K	29025lm	12°
V1-10-70096-04L02-6524040	215W	4000K	29025lm	30°
V1-10-70096-04L07-6524040	215W	4000K	29025lm	60°
V1-10-70096-04L06-6524040	215W	4000K	29025lm	90°
V1-10-70096-04L08-6524040	215W	4000K	29025lm	30°x110°
V1-10-70096-04L10-6524030	215W	3000K	27950lm	12°
V1-10-70096-04L02-6524030	215W	3000K	27950lm	30°
V1-10-70096-04L07-6524030	215W	3000K	27950lm	60°
V1-10-70096-04L06-6524030	215W	3000K	27950lm	90°
V1-10-70096-04L08-6524030	215W	3000K	27950lm	30°x110°

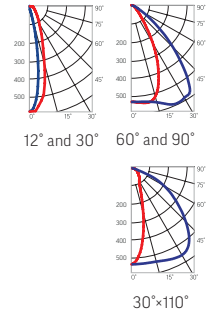



# Olymp

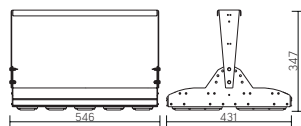

Angle of rotation – 180°  
 Lamp Size:  
 546×431×347mm  
 Package size of the  
 lamp:  
 620×567×252mm  
 PF ≥ 0,97

○ metal

Article	Power	Light temperature	Luminous flux	Angle of dispersion
V1-I0-70097-04L10-6530050	275W	5000K	37125lm	12°
V1-I0-70097-04L02-6530050	275W	5000K	37125lm	30°
V1-I0-70097-04L07-6530050	275W	5000K	37125lm	60°
V1-I0-70097-04L06-6530050	275W	5000K	37125lm	90°
V1-I0-70097-04L08-6530050	275W	5000K	37125lm	30°x110°
V1-I0-70097-04L10-6530040	275W	4000K	37125lm	12°
V1-I0-70097-04L02-6530040	275W	4000K	37125lm	30°
V1-I0-70097-04L07-6530040	275W	4000K	37125lm	60°
V1-I0-70097-04L06-6530040	275W	4000K	37125lm	90°
V1-I0-70097-04L08-6530040	275W	4000K	37125lm	30°x110°
V1-I0-70097-04L10-6530030	275W	3000K	37125lm	12°
V1-I0-70097-04L02-6530030	275W	3000K	35750lm	30°
V1-I0-70097-04L07-6530030	275W	3000K	35750lm	60°
V1-I0-70097-04L06-6530030	275W	3000K	35750lm	90°
V1-I0-70097-04L08-6530030	275W	3000K	35750lm	30°x110°

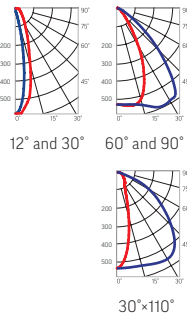

Types of installation of the Olymp lamp series



Ceiling mounting



Wall mounting

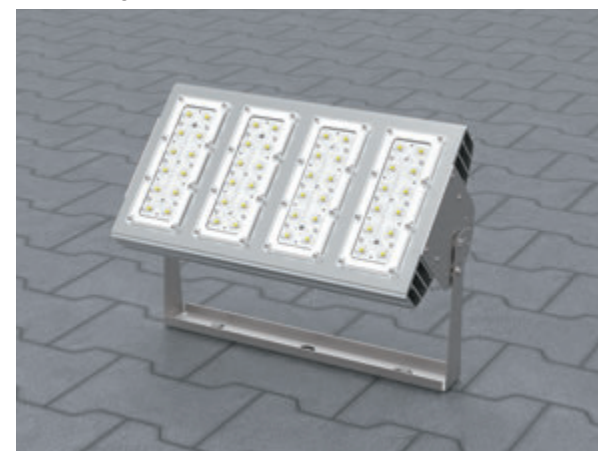

Floor mounting

Spotlight rotation angle – 180°



## Olymp S10

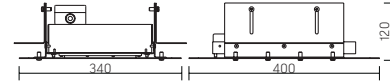

Lamp Size:  
400×340×120mm  
Package size  
of the lamp:  
420×360×150mm  
PF ≥ 0,97



○ metal

Article	Power	Light temperature	Luminous flux	Angle of dispersion
V1-I0-70106-10L05-6505550	55W	5000K	7425lm	120°
V1-I0-70106-10L08-6505550	55W	5000K	7425lm	30°×110°
V1-I0-70106-10L06-6505550	55W	5000K	7425lm	90°
V1-I0-70106-10L05-6505540	55W	4000K	7425lm	120°
V1-I0-70106-10L08-6505540	55W	4000K	7425lm	30°×110°
V1-I0-70106-10L06-6505540	55W	4000K	7425lm	90°
V1-I0-70106-10L05-6505530	55W	3000K	7150lm	120°
V1-I0-70106-10L08-6505530	55W	3000K	7150lm	30°×110°
V1-I0-70106-10L06-6505530	55W	3000K	7150lm	90°

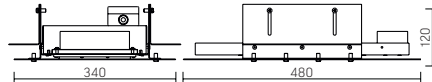
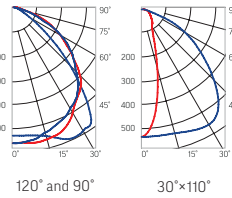

Lamp Size:  
480×340×120mm  
Package size  
of the lamp:  
500×360×150mm  
PF ≥ 0,97

○ metal

Article	Power	Light temperature	Luminous flux	Angle of dispersion
V1-I0-70107-10L05-6508550	85W	5000K	11475lm	120°
V1-I0-70107-10L08-6508550	85W	5000K	11475lm	30°×110°
V1-I0-70107-10L06-6508550	85W	5000K	11475lm	90°
V1-I0-70107-10L05-6508540	85W	4000K	11475lm	120°
V1-I0-70107-10L08-6508540	85W	4000K	11475lm	30°×110°
V1-I0-70107-10L06-6508540	85W	4000K	11475lm	90°
V1-I0-70107-10L05-6508530	85W	3000K	11050lm	120°
V1-I0-70107-10L08-6508530	85W	3000K	11050lm	30°×110°
V1-I0-70107-10L06-6508530	85W	3000K	11050lm	90°

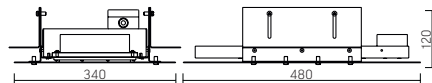
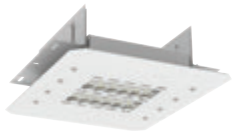
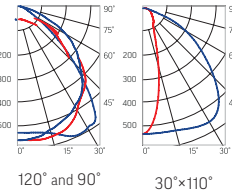

Lamp Size:  
480×340×120mm  
Package size  
of the lamp:  
500×360×150mm  
PF ≥ 0,97

○ metal

Article	Power	Light temperature	Luminous flux	Angle of dispersion
V1-I0-70108-10L05-6511550	115W	5000K	15525lm	120°
V1-I0-70108-10L08-6511550	115W	5000K	15525lm	30°×110°
V1-I0-70108-10L06-6511550	115W	5000K	15525lm	90°
V1-I0-70108-10L05-6511540	115W	4000K	15525lm	120°
V1-I0-70108-10L08-6511540	115W	4000K	15525lm	30°×110°
V1-I0-70108-10L06-6511540	115W	4000K	15525lm	90°
V1-I0-70108-10L05-6511530	115W	3000K	14950lm	120°
V1-I0-70108-10L08-6511530	115W	3000K	14950lm	30°×110°
V1-I0-70108-10L06-6511530	115W	3000K	14950lm	90°

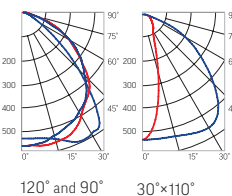

### Installation:

Ceiling installation / wall thickness from 35 to 75mm

### Case:

Aluminum anodized body, fasteners and removable decorative frame in painted steel

### Secondary optics:

To protect the LEDs used secondary optics without the use of glass, which allows high energy efficiency 110 lm / W  
Secondary optics made of acrylic resistant to physical and chemical influences

### Specifications:

Index of color transmission Ra > 75  
Temperature range from -40 ° C to + 45 ° C  
AC100-305V, 47-63Hz, DC 142-431V  
Network frequency 50Hz ± 10%  
LED life 50,000 hours  
3 year warranty  
Luminous flux Kn ≤ 1%





## Olymp HB

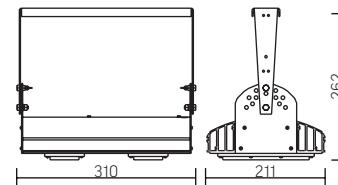

Angle of rotation – 180°  
 Lamp Size:  
 320×211×262mm  
 Package size of the lamp:  
 400×310×150mm  
 PF ≥ 0,97

Article	Power	Light temperature	Luminous flux
V1-I0-70076-04L05-6506040	55W	4000K	6200lm
V1-I0-70076-04L05-6506050	55W	5000K	6560lm

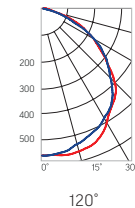

○ metal

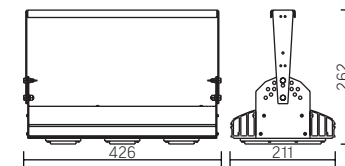

Angle of rotation – 180°  
 Lamp Size:  
 426×211×262mm  
 Package size of the lamp:  
 480×310×152mm  
 PF ≥ 0,97

Article	Power	Light temperature	Luminous flux
V1-I0-70077-04L05-6509040	85W	4000K	8400lm
V1-I0-70077-04L05-6509050	85W	5000K	9865lm
V1-I0-70077-04L05-6512040	105W	4000K	10700lm
V1-I0-70077-04L05-6512050	105W	5000K	12560lm

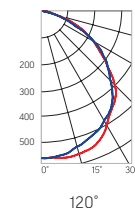

○ metal

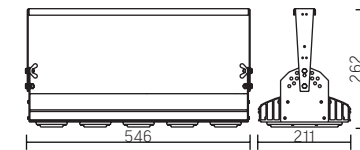

Angle of rotation – 180°  
 Lamp Size:  
 546×211×262mm  
 Package size of the lamp:  
 595×315×150mm  
 PF ≥ 0,97

Article	Power	Light temperature	Luminous flux
V1-I0-70078-04L05-6515040	140W	4000K	13700lm
V1-I0-70078-04L05-6515050	140W	5000K	16560lm

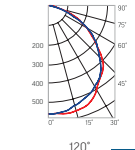

○ metal

### Installation:

Fastening on walls, ceiling and floor with the ability to adjust the angle of inclination within 180 °

### Case:

Aluminum anodized body

LED Protection:

To protect the LEDs, an acrylic cap without the use of glass is used, which allows high energy efficiency of 100lm / W

### Specifications:

Index of color transmission Ra > 75

Temperature range from -40 ° C to + 45 ° C

AC100-305V, 47-63Hz, DC142-431V

Network frequency 50Hz ± 10%

LED life 50,000 hours

3 year warranty

Luminous flux Kn ≤ 1%





**Installation:**

Mount to console with a diameter of up to 48mm

**Case:**

Aluminum anodized body

Secondary optics:

To protect the LEDs used secondary optics without the use of glass, which allows high energy efficiency.

Secondary optics made of acrylic resistant to physical and chemical influences

**Application:**

Designed for general lighting of industrial and courtyard areas and industrial, warehouse and technical premises.

**Specifications:**

Index of color transmission Ra > 75

Temperature range from -40 °C to + 45 °C

AC100-305V

Network frequency 50Hz ± 10%

LED life 50,000 hours

3 year warranty

Luminous flux Kn ≤ 1%



**Olymp K**

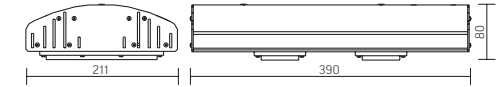

Angle of rotation – 180°  
Lamp Size:  
310×211×262mm  
Package size of the lamp:  
400×310×150mm  
PF ≥ 0,97



○ metal

Article	Power	Light temperature	Luminous flux	Angle of dispersion
V1-I0-70088-40L07-6506050	55W	5000K	7425lm	60°
V1-I0-70088-40L06-6506050	55W	5000K	7425lm	90°
V1-I0-70088-40L05-6506050	55W	5000K	7425lm	120°
V1-I0-70088-40L07-6506040	55W	4000K	7425lm	60°
V1-I0-70088-40L06-6506040	55W	4000K	7425lm	90°
V1-I0-70088-40L05-6506050	55W	4000K	7425lm	120°
V1-I0-70088-40L07-6506030	55W	3000K	7150lm	60°
V1-I0-70088-40L06-6506030	55W	3000K	7150lm	90°
V1-I0-70088-40L05-6506030	55W	3000K	7150lm	120°

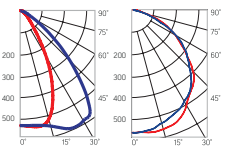

60° and 90° 120°

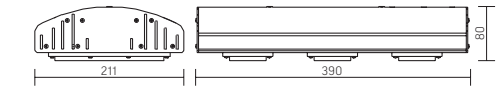

Angle of rotation - 180 °  
Lamp Size:  
426×211×262mm  
Package size of the lamp:  
480×310×152mm  
PF ≥ 0,97

○ metal

Article	Power	Light temperature	Luminous flux	Angle of dispersion
V1-I0-70088-40L07-6509050	80W	5000K	10800lm	60°
V1-I0-70088-40L06-6509050	80W	5000K	10800lm	90°
V1-I0-70088-40L05-6509050	80W	5000K	10800lm	120°
V1-I0-70088-40L07-6509040	80W	4000K	10800lm	60°
V1-I0-70088-40L06-6509040	80W	4000K	10800lm	90°
V1-I0-70088-40L05-6509040	80W	4000K	10800lm	120°
V1-I0-70088-40L07-6509030	80W	3000K	10400lm	60°
V1-I0-70088-40L06-6509030	80W	3000K	10400lm	90°
V1-I0-70088-40L05-6509030	80W	3000K	10400lm	120°

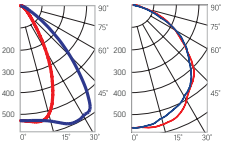

60° and 90° 120°

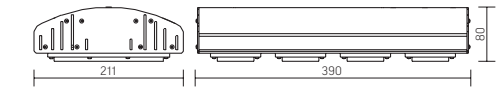

Angle of rotation - 180 °  
Lamp Size:  
426×211×262mm  
Package size of the lamp:  
480×310×152mm  
PF ≥ 0,97

○ metal

Article	Power	Light temperature	Luminous flux	Angle of dispersion
V1-I0-70088-40L07-6512050	110W	5000K	14850lm	60°
V1-I0-70088-40L06-6512050	110W	5000K	14850lm	90°
V1-I0-70088-40L05-6512050	110W	5000K	14850lm	120°
V1-I0-70088-40L07-6512040	110W	4000K	14850lm	60°
V1-I0-70088-40L06-6512040	110W	4000K	14850lm	90°
V1-I0-70088-40L05-6512040	110W	4000K	14850lm	120°
V1-I0-70088-40L07-6512030	110W	3000K	14300lm	60°
V1-I0-70088-40L06-6512030	110W	3000K	14300lm	90°
V1-I0-70088-40L05-6512030	110W	3000K	14300lm	120°

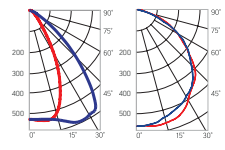

60° and 90° 120°

# OLYMP MINI

Aluminum extrusion body  
Swivel mounting bracket  
IP65



Available capacities

**30W**

**60W**

Version

**DALI**

DIMI protocol  
dimming (60W)

Optics

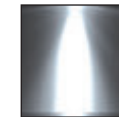

12°

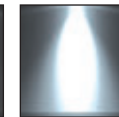

30°

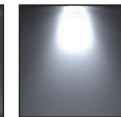

60°



90°

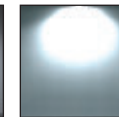

30°x110°



120°



Wide

Light temperature



3000K  
Warm white



4000K  
Neutral white



5000K  
Cold white



## Olymp Mini

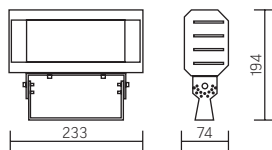

Angle of rotation – 180°

Lamp Size:

233×190×74mm

Package size of the lamp:

233×190×74mm

PF ≥ 0,97



○ metal

Article	Power	Light temperature	Luminous flux	Angle of dispersion
V1-S0-70503-04L10-6503030	30W	3000K	3750lm	12°
V1-S0-70503-04L10-6503040	30W	4000K	4050lm	12°
V1-S0-70503-04L10-6503050	30W	5000K	4050lm	12°
V1-S0-70503-04L02-6503030	30W	3000K	3750lm	30°
V1-S0-70503-04L02-6503040	30W	4000K	4050lm	30°
V1-S0-70503-04L02-6503050	30W	5000K	4050lm	30°
V1-S0-70503-04L07-6503030	30W	3000K	3750lm	60°
V1-S0-70503-04L07-6503040	30W	4000K	4050lm	60°
V1-S0-70503-04L07-6503050	30W	5000K	4050lm	60°
V1-S0-70503-04L06-6503030	30W	3000K	3750lm	90°
V1-S0-70503-04L06-6503040	30W	4000K	4050lm	90°
V1-S0-70503-04L06-6503050	30W	5000K	4050lm	90°
V1-S0-70503-04L08-6503030	30W	3000K	3750lm	30°x110°
V1-S0-70503-04L08-6503040	30W	4000K	4050lm	30°x110°
V1-S0-70503-04L08-6503050	30W	5000K	4050lm	30°x110°
V1-S0-70503-04L05-6503030	30W	3000K	3750lm	120°
V1-S0-70503-04L05-6503040	30W	4000K	4050lm	120°
V1-S0-70503-04L05-6503050	30W	5000K	4050lm	120°
V1-S0-70503-04L04-6503030	30W	3000K	3750lm	Ш
V1-S0-70503-04L04-6503040	30W	4000K	4050lm	Ш
V1-S0-70503-04L04-6503050	30W	5000K	4050lm	Ш

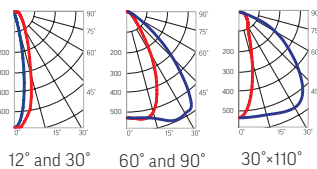

NEW MODEL



### Installation:

Mount on walls, ceiling and floor with the ability to adjust the angle of inclination within 180°

Case:

Aluminum anodized body

### Application:

The lamp is designed for general lighting of industrial, warehouse and technical premises, as well as, outdoor areas, parking lots, building facades, architectural elements of buildings.

### Specifications:

Index of color transmission Ra > 75

Temperature range from -40 °C to + 45 °C

AC100-305V, 47-63 Hz, DC 142-431V

Network frequency 50Hz ± 10%

LED life 50,000 hours

3 year warranty

Luminous flux ≤ 1%





## Olymp Mini

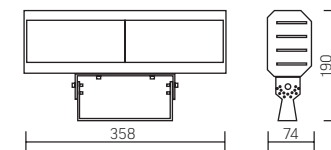

Angle of rotation – 180°  
 Lamp Size:  
 358×190×74mm  
 Package size of the lamp:  
 430×130×165mm  
 PF ≥ 0,97



○ metal

Article	Power	Light temperature	Luminous flux	Angle of dispersion
---------	-------	-------------------	---------------	---------------------

V1-S0-70504-04L10-6506030	60W	3000K	7500lm	12°
V1-S0-70504-04L10-6506040	60W	4000K	8100lm	12°
V1-S0-70504-04L10-6506050	60W	5000K	8100lm	12°
V1-S0-70504-04L02-6506030	60W	3000K	7500lm	30°
V1-S0-70504-04L02-6506040	60W	4000K	8100lm	30°
V1-S0-70504-04L02-6506050	60W	5000K	8100lm	30°
V1-S0-70504-04L07-6506030	60W	3000K	7500lm	60°
V1-S0-70504-04L07-6506040	60W	4000K	8100lm	60°
V1-S0-70504-04L07-6506050	60W	5000K	8100lm	60°
V1-S0-70504-04L06-6506030	60W	3000K	7500lm	90°
V1-S0-70504-04L06-6506040	60W	4000K	8100lm	90°
V1-S0-70504-04L06-6506050	60W	5000K	8100lm	90°
V1-S0-70504-04L08-6506030	60W	3000K	7500lm	30°x110°
V1-S0-70504-04L08-6506040	60W	4000K	8100lm	30°x110°
V1-S0-70504-04L08-6506050	60W	5000K	8100lm	30°x110°
V1-S0-70504-04L05-6506030	60W	3000K	7500lm	120°
V1-S0-70504-04L05-6506040	60W	4000K	8100lm	120°
V1-S0-70504-04L05-6506050	60W	5000K	8100lm	120°
V1-S0-70504-04L04-6506030	60W	3000K	7500lm	∩
V1-S0-70504-04L04-6506040	60W	4000K	8100lm	∩
V1-S0-70504-04L04-6506050	60W	5000K	8100lm	∩

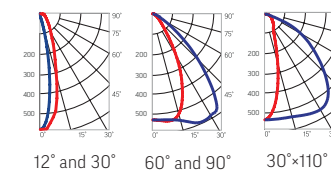

**Installation:**  
 Mount on walls, ceiling and floor with the ability to adjust the angle of inclination within 180°

**Case:**  
 Anodized Aluminum Body  
 Stainless steel swivel bracket

**Application:**  
 Designed for warehouses, access areas, exhibition sites, lighting architectural elements, buildings, etc.

**Specifications:**  
 Index of color transmission Ra > 75  
 Temperature range from -40 ° C to + 45 ° C  
 AC100-305V  
 Network frequency 50Hz ± 10%  
 LED life 50,000 hours  
 3 year warranty  
 Luminous flux Kn <1%





## Olymp Round

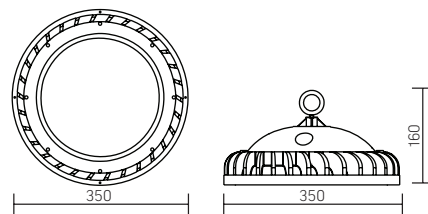

Radiation angle – 120°

Lamp Size:

350×160mm

Package size of the lamp:

375×305×140mm

PF ≥ 0,9



● grey

Article	Power	Light temperature	Luminous flux
V1-I0-70491-04L05-6510040	100W	4000K	13000lm
V1-I0-70491-04L05-6510050	100W	5000K	13000lm

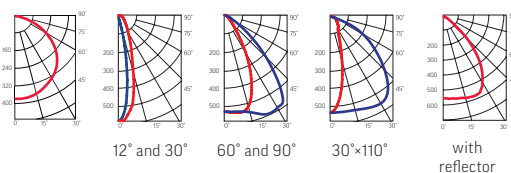

## Accessories for the Olymp Round lamp



Article	Description
V4-I0-70.0002.0LR-0001	Olymp Round swivel mount Used for surface-mounted installation of the lamp and the orientation of the lamp at a certain angle. Allows you to rotate the lamp in the range of -90° .. +90° in increments of 20°



Article	Name
V4-I0-70.0036.0LR-0001	Reflector Olymp Round 80° Designed to form a scattering angle of 80° and reduce the glare effect. Efficiency 82%. Attached to the lamp body with screws screwed into the rim of the lamp

NEW MODEL



### Installation:

Mounted with suspension. Surface mounting is possible when using a swivel bracket (optional accessory).

### Case:

Cast aluminum case. Strained glass.

### Application:

The lamp is designed to illuminate industrial premises and production sites.

### Specifications:

Index of color transmission Ra > 75

Temperature range from -40 °C to + 45 °C

AC100-305V, 47-63Hz, DC 142-431V

LED life 50,000 hours

3 year warranty

Luminous flux Kn ≤ 1%



Central Park of Culture and Recreation, CPCaR (St. Petersburg, Russia)



**OUTDOOR LIGHTING**

# TORNADO

Aluminum die-cast housing  
Strained glass  
Installation without tools



## Available capacities

**80W** **160W**

**100W** **190W**

**120W** **210W**

## Version

**DALI**

Dimmable (DALI, 0..10V, PWM)



Xtrem  
(for low temperatures -60°C)



Basic colors: white, gray, black.  
Any body color on request.

## Optics



Basic optics: street (technical task).  
Selection of optics for the project.

## Light temperature

 2700K  
Warm white

 4000K  
Neutral white

 5000K  
Cold white

# TORNADO



DALI 1-10B PWM

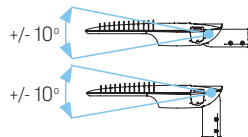

Lamp Size:  
700x310x90  
Package size of the lamp:  
745x350x190



○ white ○ grey ● black

Article	Power	Light temperature	Luminous flux
V1-S1-x0443-40L30-6612050	80W	5000K	10800lm
V1-S1-x0443-40L30-6612040	80W	4000K	10800lm
V1-S1-x0443-40L30-6612027	80W	2700K	9600lm
V1-S1-x0442-40L30-6616050	100W	5000K	10800lm
V1-S1-x0442-40L30-6616040	100W	4000K	13500lm
V1-S1-x0442-40L30-6616027	100W	2700K	12000lm

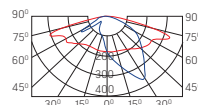

x: 0 - white color of the case, 7 - gray color of the case, 9 - black color of the case

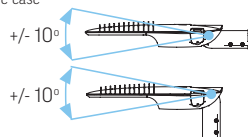

DALI 1-10B PWM

Lamp Size:  
700x310x110  
Package size of the lamp:  
745x350x190

○ white ○ grey ● black

Article	Power	Light temperature	Luminous flux
V1-S1-x0441-40L30-6612050	120W	5000K	16200lm
V1-S1-x0441-40L30-6612040	120W	4000K	16200lm
V1-S1-x0441-40L30-6612027	120W	2700K	14400lm

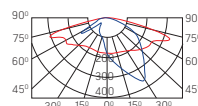

x: 0 - white color of the case, 7 - gray color of the case, 9 - black color of the case

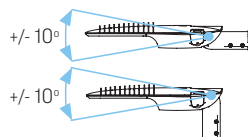

DALI 1-10B PWM

Lamp Size:  
840x310x110  
Package size of the lamp:  
865x350x190

○ white ○ grey ● black

Article	Power	Light temperature	Luminous flux
V1-S1-x0442-40L30-6616050	160W	5000K	21600lm
V1-S1-x0442-40L30-6616040	160W	4000K	21600lm
V1-S1-x0442-40L30-6616027	160W	2700K	19200lm
V1-S1-x0442-40L30-6619050	190W	5000K	25650lm
V1-S1-x0442-40L30-6619040	190W	4000K	25650lm
V1-S1-x0442-40L30-6619027	190W	2700K	22800lm
V1-S1-x0442-40L30-6621050	210W	5000K	28350lm
V1-S1-x0442-40L30-6621040	210W	4000K	28350lm
V1-S1-x0442-40L30-6621027	210W	2700K	25200lm

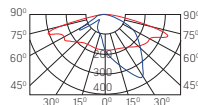

x: 0 - white color of the case, 7 - gray color of the case, 9 - black color of the case

NEW MODEL



**Installation:**

Mounting on a mast or console from 48 mm to 60 mm

**Case:**

- Aluminum die-cast housing
- Protective glass
- Effective secondary optics

**Application:**

Designed for functional lighting of class A, B, C roads.

**Specifications:**

- Index of color transmission Ra > 75
- Temperature range -40 °C to + 45 °C
- AC100-305V (50Hz)
- LED life 50,000 hours
- 3 year warranty
- Luminous flux Kn ≤5%
- PF≥0.97





# URAN



## Available capacities

**55W**

**135W**

**80W**

**160W**

**110W**

**250W**

## Version

**DALI**

Dimming Protocol DALI

**1-10**

Dimming Protocol 1-10V

**ШИМ**

Dimming Protocol PWM



Xtrem  
(for low temperatures -60°C)

## Optics

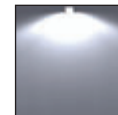

Wide (T3)

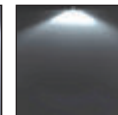

For parking (T5)

## Light temperature

 3000K  
Warm white

 4000K  
Neutral white

 5000K  
Cold white





**Installation:**

Mount to console with a diameter of up to 48mm

**Case:**

Aluminum anodized body

**Secondary optics:**

To protect the LEDs used secondary optics without the use of glass, which allows high energy efficiency.

Secondary optics made of acrylic resistant to physical and chemical influences

**Application:**

Designed for functional lighting of class A, B, C roads.

**Specifications:**

Index of color transmission Ra > 75

Temperature range from -40 ° C to + 45 ° C

AC100-305V

Network frequency 50Hz ± 10%

LED life 50,000 hours

3 year warranty

Luminous flux Kn ≤ 1%

**Uran**

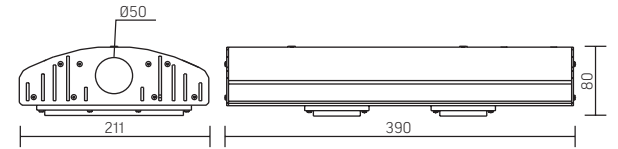

Lamp Size:  
390×211×80mm  
Package size for lamps:  
446×233×112mm  
PF ≥ 0,97



○ metal

Article	Power	Light temperature	Luminous flux
V1-S1-70087-40L04-6506050	55W	5000K	7425lm
V1-S1-70087-40L04-6506040	55W	4000K	7425lm
V1-S1-70087-40L04-6506030	55W	3000K	7150lm

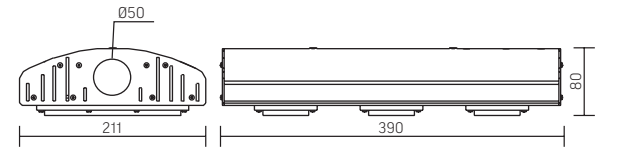
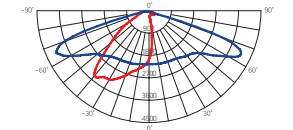

Lamp Size:  
390×211×80mm  
Package size for lamps:  
446×233×112mm  
PF ≥ 0,97

○ metal

Article	Power	Light temperature	Luminous flux
V1-S1-70088-40L04-6509050	80W	5000K	10800lm
V1-S1-70088-40L04-6509040	80W	4000K	10800lm
V1-S1-70088-40L04-6509030	80W	3000K	10400lm

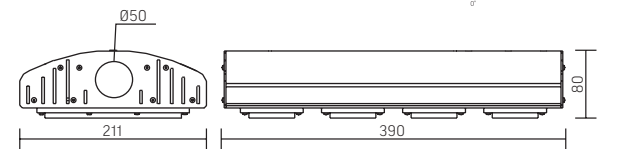
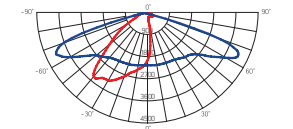

Lamp Size:  
390×211×80mm  
Package size for lamps:  
446×233×112mm  
PF ≥ 0,97

○ metal

Article	Power	Light temperature	Luminous flux
V1-S1-70089-40L04-6512050	110W	5000K	14850lm
V1-S1-70089-40L04-6512040	110W	4000K	14850m
V1-S1-70089-40L04-6512030	110W	3000K	14300lm

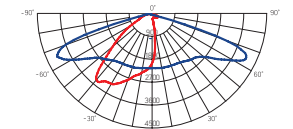

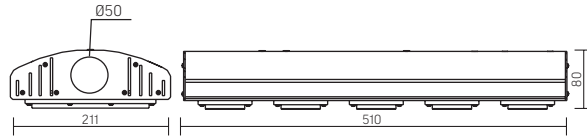

Lamp Size:  
510×211×80mm  
Package size for lamps:  
570×233×112mm  
PF ≥ 0,97

○ metal

Article	Power	Light temperature	Luminous flux
V1-S1-70090-40L04-6515050	135W	5000K	18225lm
V1-S1-70090-40L04-6515040	135W	4000K	18225lm
V1-S1-70090-40L04-6515030	135W	3000K	17550lm

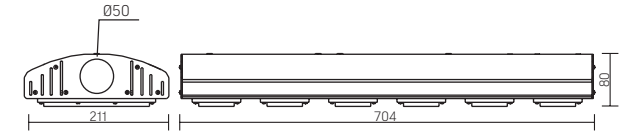
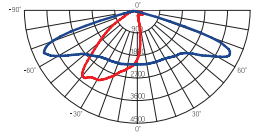

Lamp Size:  
704×211×80mm  
Package size for lamps:  
710×233×112mm  
PF ≥ 0,97

○ metal

Article	Power	Light temperature	Luminous flux
V1-S1-70117-40L04-6525050	250W	5000K	32000lm
V1-S1-70117-40L04-6525040	250W	4000K	31250lm

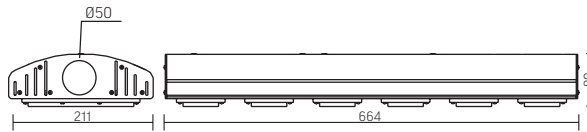
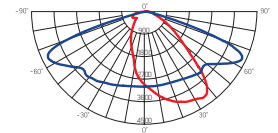

Lamp Size:  
664×211×80mm  
Package size for lamps:  
710×233×112mm  
PF ≥ 0,97

○ metal

Article	Power	Light temperature	Luminous flux
V1-S1-70091-40L04-6518050	160W	5000K	21600lm
V1-S1-70091-40L04-6518040	160W	4000K	21600lm
V1-S1-70091-40L04-6518030	160W	3000K	20800lm

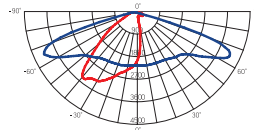





**Installation:**

Mount to console with a diameter of up to 48mm

**Case:**

Aluminum anodized body

**Secondary optics:**

To protect the LEDs used secondary optics without the use of glass, which allows high energy efficiency.

Secondary optics made of acrylic resistant to physical and chemical influences

**Application:**

Designed for functional lighting of class A, B, C roads (including in conditions of extremely low temperatures)

**Specifications:**

Index of color transmission Ra > 75  
Temperature range from -60 ° C to + 45 ° C

AC176-305V

Network frequency 50Hz ± 10%

LED life 50,000 hours

3 year warranty

Luminous flux Kn ≤ 1%

**Uran Xtrem**

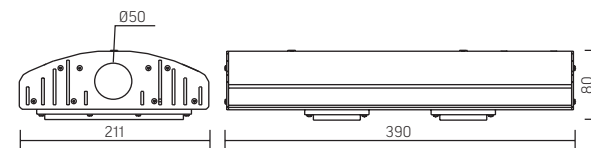

Lamp Size:  
390×211×80mm  
Package size of the lamp:  
446×233×112mm  
PF ≥ 0,97



○ metal

Article	Power	Light temperature	Luminous flux
V1-S1-70087-40T04-6506050	55W	5000K	7425lm
V1-S1-70087-40T04-6506040	55W	4000K	7425lm
V1-S1-70087-40T04-6506030	55W	3000K	7150lm

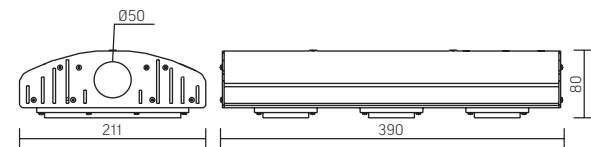
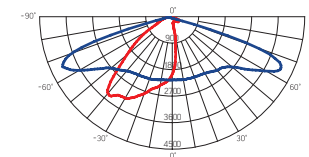

Lamp Size:  
390×211×80mm  
Package size of the lamp:  
446×233×112mm  
PF ≥ 0,97

○ metal

Article	Power	Light temperature	Luminous flux
V1-S1-70088-40T04-6509050	80W	5000K	10800lm
V1-S1-70088-40T04-6509040	80W	4000K	10800lm
V1-S1-70088-40T04-6509030	80W	3000K	10400lm

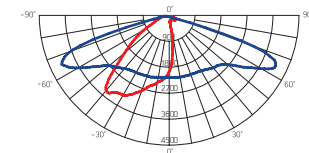

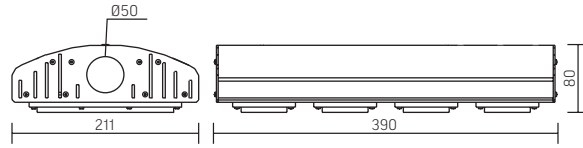

Lamp Size:  
390×211×80mm  
Package size of the lamp:  
446×233×112mm  
PF ≥ 0,97

○ metal

Article	Power	Light temperature	Luminous flux
V1-S1-70089-40T04-6512050	110W	5000K	14850lm
V1-S1-70089-40T04-6512040	110W	4000K	14850lm
V1-S1-70089-40T04-6512030	110W	3000K	14300lm

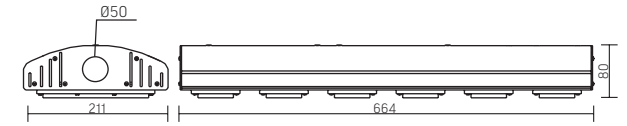
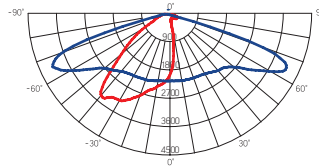

Lamp Size:  
664×211×80mm  
Package size of the lamp:  
710×233×112mm  
PF ≥ 0,97

○ metal

Article	Power	Light temperature	Luminous flux
V1-S1-70091-40T04-6518050	160W	5000K	21600lm
V1-S1-70091-40T04-6518040	160W	4000K	21600lm
V1-S1-70091-40T04-6518030	160W	3000K	20800lm

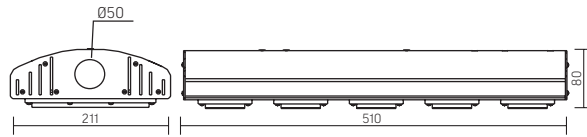
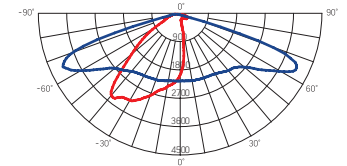

Lamp Size:  
510×211×80mm  
Package size of the lamp:  
570×233×112mm  
PF ≥ 0,97

○ metal

Article	Power	Light temperature	Luminous flux
V1-S1-70090-40T04-6515050	135W	5000K	18225lm
V1-S1-70090-40T04-6515040	135W	4000K	18225lm
V1-S1-70090-40T04-6515030	135W	3000K	17550lm

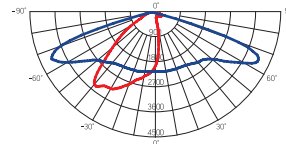



**Installation:**

Mount to console with a diameter of up to 48mm

**Case:**

Aluminum anodized body

**Secondary optics:**

To protect the LEDs used secondary optics without the use of glass, which allows to achieve high energy efficiency.

Secondary optics made of acrylic resistant to physical and chemical influences

**Application:**

Designed for lighting sites with high demands on uniformity of illumination, such as parking, squares and squares.

**Specifications:**

Index of color transmission Ra > 75  
Temperature range from -40 ° C to + 45 ° C

AC100-305V  
Network frequency 50Hz ± 10%  
LED life 50,000 hours  
3 year warranty  
Luminous flux Kn ≤ 1%

**Uran P**

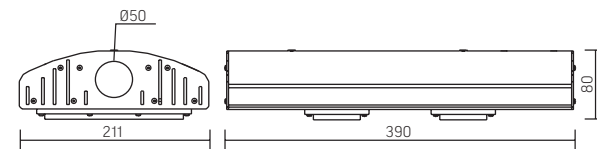

Lamp Size:  
390×211×80mm  
Package size of the lamp:  
446×233×112mm  
PF ≥ 0,97



○ metal

Article	Power	Light temperature	Luminous flux
V1-S1-70087-40L24-6506050	55W	5000K	7425lm
V1-S1-70087-40L24-6506040	55W	4000K	7425lm
V1-S1-70087-40L24-6506030	55W	3000K	7150lm

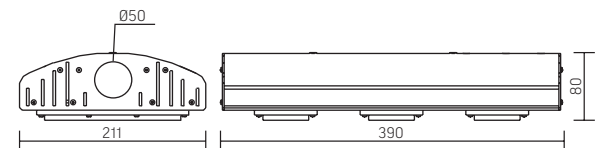
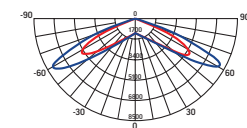

Lamp Size:  
390×211×80mm  
Package size of the lamp:  
446×233×112mm  
PF ≥ 0,97

○ metal

Article	Power	Light temperature	Luminous flux
V1-S1-70088-40L24-6509050	80W	5000K	10800lm
V1-S1-70088-40L24-6509040	80W	4000K	10800lm
V1-S1-70088-40L24-6509030	80W	3000K	10400lm

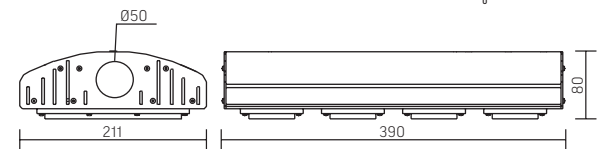
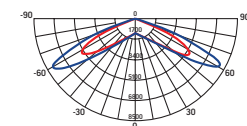

Lamp Size:  
390×211×80mm  
Package size of the lamp:  
446×233×112mm  
PF ≥ 0,97

○ metal

Article	Power	Light temperature	Luminous flux
V1-S1-70089-40L24-6512050	110W	5000K	14850lm
V1-S1-70089-40L24-6512040	110W	4000K	14850lm
V1-S1-70089-40L24-6512030	110W	3000K	14300lm

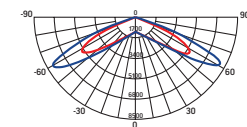

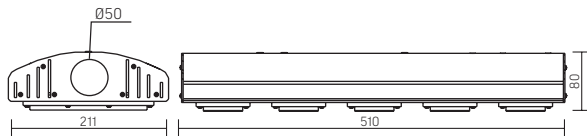

Lamp Size:  
510×211×80mm  
Package size of the lamp:  
570×233×112mm  
PF ≥ 0,97

○ metal

Article	Power	Light temperature	Luminous flux
V1-S1-70090-40L24-6515050	135W	5000K	18225m
V1-S1-70090-40L24-6515040	135W	4000K	18225m
V1-S1-70090-40L24-6515030	135W	3000K	17550m

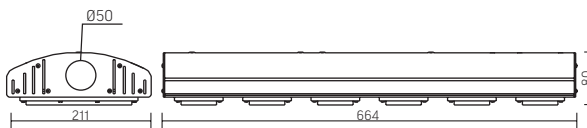
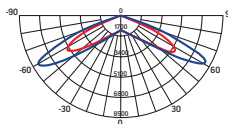

Lamp Size:  
664×211×80mm  
Package size of the lamp:  
710×233×112mm  
PF ≥ 0,97

○ metal

Article	Power	Light temperature	Luminous flux
V1-S1-70091-40L24-6518050	160W	5000K	21600lm
V1-S1-70091-40L24-6518040	160W	4000K	21600lm
V1-S1-70091-40L24-6518030	160W	3000K	20800lm

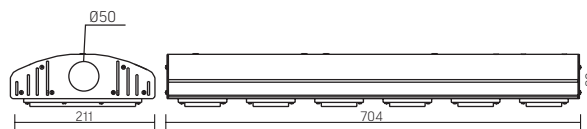
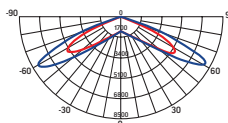

Lamp Size:  
704×211×80mm  
Package size of the lamp:  
710×233×112mm  
PF ≥ 0,97

○ metal

Article	Power	Light temperature	Luminous flux
V1-S1-70117-40L24-6525040	250B <sub>T</sub>	4000K	31250lm
V1-S1-70117-40L24-6525050	250B <sub>T</sub>	5000K	32000lm

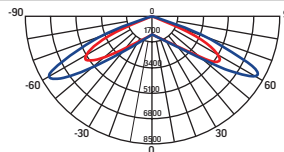



Available capacities

**30W**

**60W**

Version (60W)

**DALI**

Dimming Protocol DALI

**1-10**

Dimming Protocol 1-10V

**ШИМ**

Dimming Protocol PWM

Optics

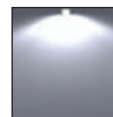

Wide (T3)



For parking  
(T5)

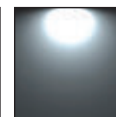

Cosine

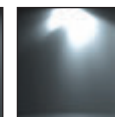

For crosswalks

Light temperature

 3000K  
Warm white

 4000K  
Neutral white

 5000K  
Cold white



# URAN MINI

NEW  
MODEL



**Installation:**  
Mount to console with a diameter of up to 48mm

**Case:**  
Aluminum anodized body

**Application:**  
Designed for lighting sites with high demands on uniformity of illumination, such as parking, squares and squares.

**Specifications:**  
Index of color transmission  $R_a > 75$   
Temperature range from  $-40^{\circ}\text{C}$  to  $+45^{\circ}\text{C}$   
AC100-305V  
Network frequency  $50\text{Hz} \pm 10\%$   
LED life 50,000 hours  
3 year warranty  
Luminous flux  $K_n \leq 1\%$



## Uran Mini

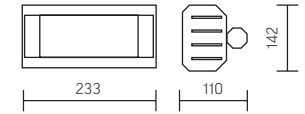

Lamp Size:  
233×110×142mm  
Package size of the  
lamp:305×130×165mm  
PF ≥ 0,97



○ metal

Article	Power	Light temperature	Luminous flux
V1-S1-70459-40L04-6503030	30W	3000K	3750lm
V1-S1-70459-40L04-6503040	30W	4000K	4050lm
V1-S1-70459-40L04-6503050	30W	5000K	4050lm
V1-S1-70459-40L05-6503030	30W	3000K	3750lm
V1-S1-70459-40L05-6503040	30W	4000K	4050lm
V1-S1-70459-40L05-6503050	30W	5000K	4050lm
V1-S1-70459-40L24-6503030	30W	3000K	3750lm
V1-S1-70459-40L24-6503040	30W	4000K	4050lm
V1-S1-70459-40L24-6503050	30W	5000K	4050lm

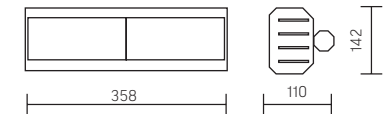
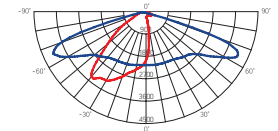

Lamp Size:  
358×110×142mm  
Package size of the  
lamp:430×130×165mm  
PF ≥ 0,97

○ metal

Article	Power	Light temperature	Luminous flux
V1-S1-70460-40L04-6506030	60	3000	7500
V1-S1-70460-40L04-6506040	60	4000	8100
V1-S1-70460-40L04-6506050	60	5000	8100
V1-S1-70460-40L05-6506030	60	3000	7500
V1-S1-70460-40L05-6506040	60	4000	8100
V1-S1-70460-40L05-6506050	60	5000	8100
V1-S1-70460-40L25-6506050	60	5000	8100
V1-S1-70460-40L24-6506030	60	3000	7500
V1-S1-70460-40L24-6506040	60	4000	8100
V1-S1-70460-40L24-6506050	60	5000	8100

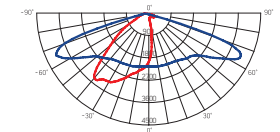

## Village / Village L120

265×255×140mm

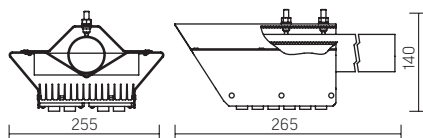

Package size of the lamp:  
340×280×155mm  
PF ≥ 0,97



○ metal

Article	Power	Light temperature	Luminous flux
---------	-------	-------------------	---------------

V1-S0-70079-40L04-6503050	30W	5000K	3750lm
V1-S0-70079-40L04-6506050	60W	5000K	5700lm
V1-S0-70079-40L04-6509050	90W	5000K	9000lm

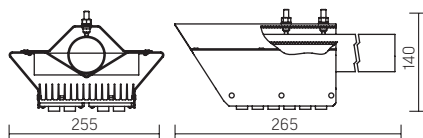
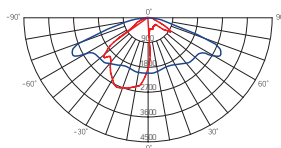

Package size of the lamp:  
340×280×155mm  
PF ≥ 0,97

○ metal

Article	Power	Light temperature	Luminous flux
---------	-------	-------------------	---------------

V1-S0-70079-40L05-6503050	30W	5000K	3750lm
V1-S0-70079-40L05-6506050	60W	5000K	6000lm

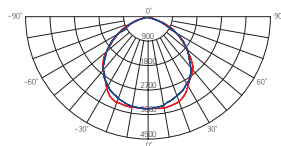

### Installation:

Console mount with a diameter of 40mm to 60mm

### Secondary optics:

Secondary optics without glass is used to protect the LEDs.  
Secondary optics made of acrylic resistant to physical and chemical influences

### Specifications:

Index of color transmission Ra > 75  
Temperature range from -40 °C to + 45 °C  
AC100-240V  
Network frequency 50Hz ± 10%  
LED life 50,000 hours  
1 year warranty  
Luminous flux of the lamp 30W and 90W Kn = 1%  
Luminous flux of the lamp 60W Kn = 18.5%



**Triumph**  
467×330×90mm

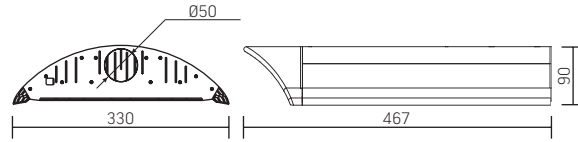

Shield glass:  
Made of tempered glass  
Package size of the lamp:  
506×346×94mm  
PF ≥ 0,97



Article	Power	Light temperature	Luminous flux
V1-S0-70057-40L04-6506065	60W	6500K	6900lm
V1-S0-70057-40L04-6509065	90W	6500K	10350lm
V1-S0-70057-40L04-6512065	120W	6500K	13800lm

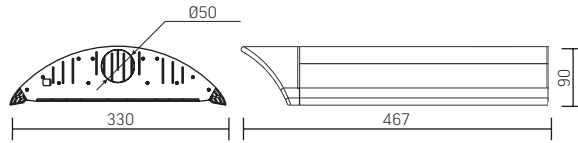
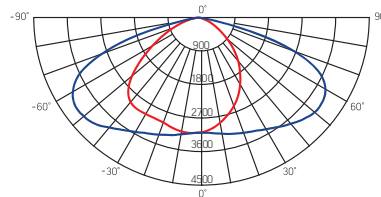

Version without  
secondary optics

Article	Power	Light temperature	Luminous flux
V1-S0-70057-40L05-6506065	60W	6500K	6900lm
V1-S0-70057-40L05-6509065	90W	6500K	10350lm
V1-S0-70057-40L05-6512065	120W	6500K	13800lm

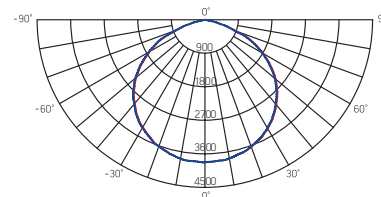

**Installation:**

Console design for  
pipe diameter 48mm  
Adapter bracket  
V4-S0-70.0003-TR0-0001  
for mounting on pipe up to 60mm

**Case:**

Aluminum anodized housing with plastic end caps made of cold-resistant ABS plastic  
Secondary optics

It is made with the use of light-distributing lenses to achieve a wide diagram in one plane, and a shift of the light flux to the roadway in another

**Protective glass:**

Made of tempered glass

**Application**

Designed for functional lighting of streets, courtyard territory, parking lots and roads with low, medium and high traffic (with the exception of the A1 class motorways)

**Specifications:**

Index of color transmission Ra > 75  
Temperature range from -40 °C to + 45 °C  
AC100-305V  
Network frequency 50Hz ± 10%  
LED life 50,000 hours  
3 year warranty  
Luminous flux Kn ≤ 1%





NEW  
MODEL



**Installation:**

Mounting on the mast from 48 mm to 60 mm

**Case:**

Polycarbonate body

Acrylic diffuser

**Application:**

Designed for lighting parks and squares

**Specifications:**

Index of color transmission Ra > 75

Temperature range -40C to + 40C

AC100-305V (50Hz)

LED life 50,000 hours

3 year warranty

PF≥0.97



RETRO



Lamp Size:  
670x375x375 mm  
Package size of the lamp:  
700x390x390 mm



● black

Article	Power	Light temperature	Luminous flux
V1-S0-90501-40000-3004030	40W	3000K	3400lm
V1-S0-90501-40000-3004040	40W	4000K	3800lm

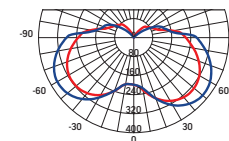

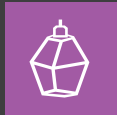

## DECORATIVE LIGHTING

## Professional tape Varton™ DC 24V RGB IP20

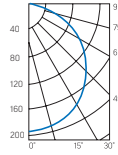
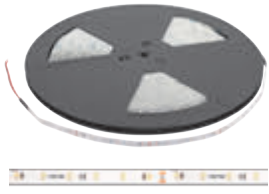

Roll length: 40 m  
Belt Width: 10 mm  
The number of LEDs per meter: 60  
The multiplicity of the length of the segment: 5 cm  
Tape power: DC 24 V

Article	Power	Light temperature	Luminous flux
VLS-20-048-2835-08-060-30	4,8 W/m	3000K	400 lm/m
VLS-20-048-2835-08-060-40	4,8 W/m	4000K	400 lm/m



○ white

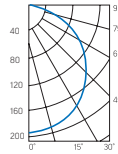
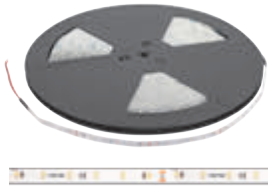

Roll length: 40 m  
Belt Width: 8 mm  
The number of LEDs per meter: 120  
The multiplicity of the length of the segment: 5 cm  
Tape power: DC 24 V

Article	Power	Light temperature	Luminous flux
VLS-20-096-3528-08-120-30	9,6 W/m	3000K	800 lm/m
VLS-20-096-3528-08-120-40	9,6 W/m	4000K	800 lm/m



○ white

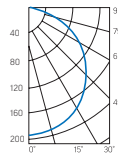
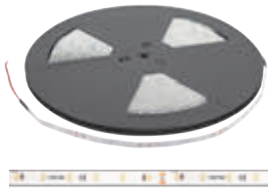

Roll length: 40 m  
Belt Width: 8 mm  
The number of LEDs per meter: 60  
The multiplicity of the length of the segment: 5 cm  
Tape power: DC 24 V

Article	Power	Light temperature	Luminous flux
VLS-20-144-2835-10-060-30	14,4 W/m	3000K	1000 lm/m
VLS-20-144-2835-10-060-40	14,4 W/m	4000K	1000 lm/m



○ white

### Installation:

The LED strip is mounted on a flat horizontal or vertical surface through an aluminum profile.

The reverse side of the tape Varton™ glued with double sided tape 3M.

### Specifications:

Index of color transmission Ra > 92

Temperature range from + 1 ° C to + 40 ° C

LED life 50,000 hours

3 year warranty provided when the tape is connected to the mains using power sources recommended by Varton™

Luminous flux angle 120 °





## Professional tape Varton™ DC 24V IP68

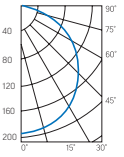

Roll length: 10 m  
 Belt Width: 8 mm  
 Number of LEDs per meter: 120  
 The multiplicity of the length of the segment: 5 cm  
 Tape power: DC 24 V

Article	Power	Light temperature	Luminous flux
VLS-68-096-3528-08-120-40	9,6 W/m	4000K	600 lm/m



○ white

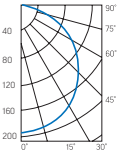

Roll length: 10 m  
 Belt Width: 10 mm  
 Number of LEDs per meter: 60  
 The multiplicity of the length of the segment: 5 cm  
 Tape power: DC 24 V

Article	Power	Light temperature	Luminous flux
VLS-68-144-2835-10-060-40	14,4 W/m	4000K	800 lm/m



○ white

### Installation:

The IP68 LED strip is mounted directly on a flat horizontal or vertical surface or through an aluminum profile. Plastic mounting brackets are supplied with Varton™ IP68 tape.

### Specifications:

Index of color transmission Ra > 92  
 Temperature range from -20 °C to +40 °C  
 LED life 50,000 hours

3 year warranty provided when the tape is connected to the mains using power sources recommended by Varton™  
 Light angle 120°



## Professional tape Varton™ DC 24V RGB IP20

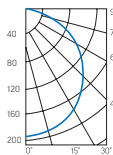
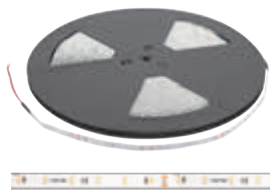

Roll length: 40 m  
 Belt Width: 10 mm  
 The number of LEDs per meter: 30  
 The multiplicity of the length of the segment: 5 cm  
 Tape power: DC 24V

Article	Power	Light temperature	Luminous flux
VLS-20-072-5050-10-030-XX	7,2 W/m	RGB	250 lm/m

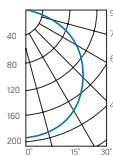
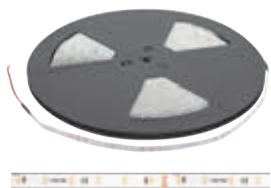

Roll length: 40 m  
 Belt Width: 10 mm  
 The number of LEDs per meter: 60  
 The multiplicity of the length of the segment: 5 cm  
 Tape power: DC 24V

Article	Power	Light temperature	Luminous flux
VLS-20-144-5050-10-060-XX	14,4W/m	RGB	500 lm/m

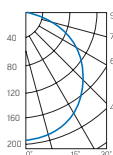
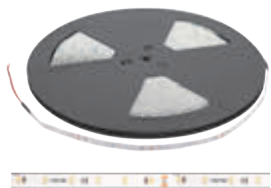

Roll length: 40 m  
 Belt Width: 10 mm  
 The number of LEDs per meter: 60  
 The multiplicity of the length of the segment: 5 cm  
 Tape power: DC 24V

Article	Power	Light temperature	Luminous flux
VLS-20-144-3535-10-120-XX	14,4 W/m	RGB	600 lm/m

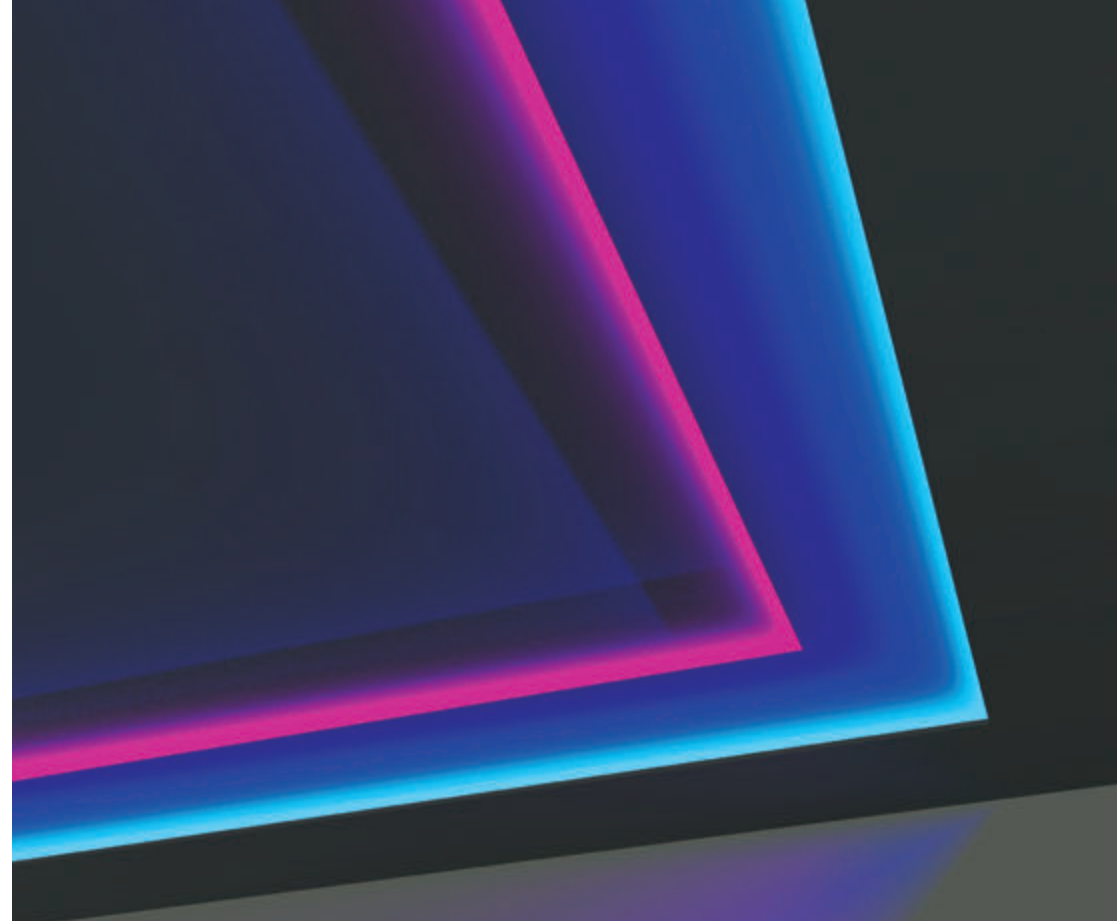

### Installation:

The LED strip is mounted on a flat horizontal or vertical surface through an aluminum profile. The reverse side of the tape Varton™ glued with double sided tape 3M.

### Specifications:

Temperature range from + 1 ° C to + 40 ° C

LED life 50,000 hours

3 year warranty provided when the tape is connected to the mains using power sources recommended by Varton™  
 Light angle 120 °





## Professional tape Varton™ DC 24V RGB IP68

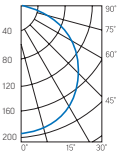

Roll length: 5 m  
 Belt Width: 10 mm  
 The number of LEDs per meter: 30  
 The multiplicity of the length of the segment: 5 cm  
 Tape power: DC 24V

Article	Power	Light temperature	Luminous flux
VLS-68-072-5050-10-030-XX	7,2 W/m	RGB	250 lm/m

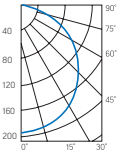
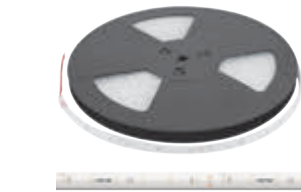

Roll length: 5 m  
 Belt Width: 10 mm  
 The number of LEDs per meter: 60  
 The multiplicity of the length of the segment: 5 cm  
 Tape power: DC 24V

Article	Power	Light temperature	Luminous flux
VLS-68-144-5050-10-060-XX	14,4W/m	RGB	500 lm/m

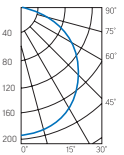

Roll length: 5 m  
 Belt Width: 10 mm  
 The number of LEDs per meter: 60  
 The multiplicity of the length of the segment: 5 cm  
 Tape power: DC 24V

Article	Power	Light temperature	Luminous flux
VLS-68-144-3535-10-120-XX	14,4 W/m	RGB	600 lm/m



### Installation:

The IP68 LED strip is mounted directly on a flat horizontal or vertical surface or through an aluminum profile. Plastic mounting brackets are supplied with Varton™ IP68 tape.

### Specifications:

Temperature range from -20 °C to + 40 °C

LED life 50,000 hours

3 year warranty provided when the tape is connected to the mains using power sources recommended by Varton™  
 Light angle 120°



## Professional tape Varton™ AC/DC 230V IP65

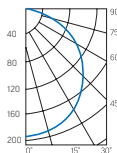
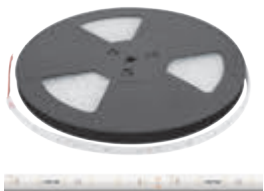

Roll length: 50 m  
Belt Width: 16 mm  
The number of LEDs per meter: 54



○ white

Article	Power	Light temperature	Luminous flux
VLS-65-008-5050-16-054-40	8 W/m	4000K	600 lm/m

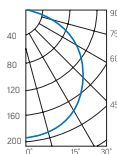

Roll length: 50 m  
Belt Width: 16 mm  
The number of LEDs per meter: 72



○ white

Article	Power	Light temperature	Luminous flux
VLS-65-014-3056-16-072-40	14 W/m	4000K	800 lm/m



### Installation:

LED strip is mounted on a flat horizontal or vertical surface  
Plastic mounting brackets are supplied with Varton™ IP65 tape

### Specifications:

Index of color transmission Ra > 90  
Temperature range from -20 °C to + 40 °C  
LED life, 50,000 hours  
AC220-240V, 50 Hz  
3 year warranty  
Light angle 120 °





**Tape NEON**



Roll length: 15 m  
 Tape diameter: 18 mm  
 The number of LEDs per meter: 108  
 Length of cut: 30 cm  
 Minimum bend radius: 50 mm  
 Tape power: DC 24 V

Article	Power	Light temperature	Luminous flux
VLS-65-006-2835-18-108-30	6 W/m	3000K	300 lm/m
VLS-65-006-2835-18-108-40	6 W/m	4000K	300 lm/m































**Installation:**  
 The tape is mounted on a flat horizontal or vertical surface with transparent plastic fasteners (supplied).

**Specifications:**  
 Index of color transmission Ra > 83  
 Temperature range from -20 ° C to + 40 ° C  
 LED life 50,000 hours  
 1 year warranty provided when the tape is connected to the mains using power sources recommended by Varton™  
 Light angle 330 °





## Accessories for LED tape

	Article	Name
	V4-R0-70.0001.KIT-0202	Aluminum profile for LED tape opal diffuser recessed 2000h30h11mm (the mounting dimension of 24 mm, suitable for tape with a maximum width of 10 mm)
	V4-R0-70.0001.KIT-0222	End cover for embedded profile, blind, 30x11 mm
	V4-R0-70.0001.KIT-0212	End cover for embedded profile with a hole, plastic 30x11 mm
	V4-R0-70.0001.KIT-0203	Aluminum profile for LED tape with a diffuser angular angle 2000x16x16 mm (maximum tape width 10 mm)
	V4-R0-70.0001.KIT-0223	End cap for corner profile blind
	V4-R0-70.0001.KIT-0213	End cap for an angular profile with a hole 16x16 mm
	V4-R0-70.0001.KIT-0233	Mounting bracket for an angular profile of metal 16x16 mm
	V4-R0-70.0001.KIT-0201	Aluminum profile for LED strips with a lens of attaching opal 2000x24x11 mm (maximum tape width 10 mm)
	V4-R0-70.0001.KIT-0221	End cover for patch profile blind plastic 24x11 mm
	V4-R0-70.0001.KIT-0211	End cap for patch profile with a hole of plastic 24x11 mm
	V4-R0-70.0001.KIT-0231	Mounting bracket for surface profile of plastic
	V4-R0-70.0024.KIT-5521	5.5 / 2.1mm Crystal connector for connecting the LED tape IP65 to the power supply female
	V4-R0-70.0024.KIT-5522	5.5 / 2.1mm Crystal connector for connecting an IP65 LED ribbon to a male power source
	V4-R0-70.0024.KIT-1015	Connector for power supply LED strip power 14.4W / m IP20 10mm
	V4-R0-70.0024.KIT-0815	Connector for power supply LED strip power 9.6W / m IP20 8mm
	V4-R0-70.0024.KIT-1000	Connector fixed for LED strip 14,4W / m IP20 10mm (connection of 2 tapes)
	V4-R0-70.0024.KIT-0800	Connector fixed for LED strip 9,6W / m IP20 8mm (connection of 2 tapes)
	V4-R0-70.0007.KIT-0100	Silicone end cap for LED strip 14.4W 10mm
	V4-R0-70.0007.KIT-0102	Silicone end cap for LED strip 14.4W 10mm with two holes for the output wires
	V4-R0-70.0007.KIT-0080	Silicone end cap for LED strip 9.6W 8mm
	V4-R0-70.0007.KIT-0082	Silicone end cap for LED strip 9.6W 8mm with two holes for the output wires
	V4-R0-70.0024.KIT-1030	Swivel mount for LED strip 14.4W / m (L-turn)
	V4-R0-70.0024.KIT-1040	Swivel mount for LED strip 14.4W / m (T-turn)
	V4-R0-70.0024.KIT-1010	Swivel mount for LED strip 9.6W / m (L-turn)
	V4-R0-70.0024.KIT-1020	Swivel mount for LED strip 9.6W / m (T-turn)
	V4-R0-70.0007.KIT-0331	Adhesive tape 33000x11,5mm for LED strip IP68
	V4-R0-70.0024.STR-0001	4PIN connector for LED strip RGB 10mm (connection of 2 tapes)
	V4-R0-70.0024.STR-0002	4PIN connector for LED strip RGB 10mm (connection of 2 tapes)

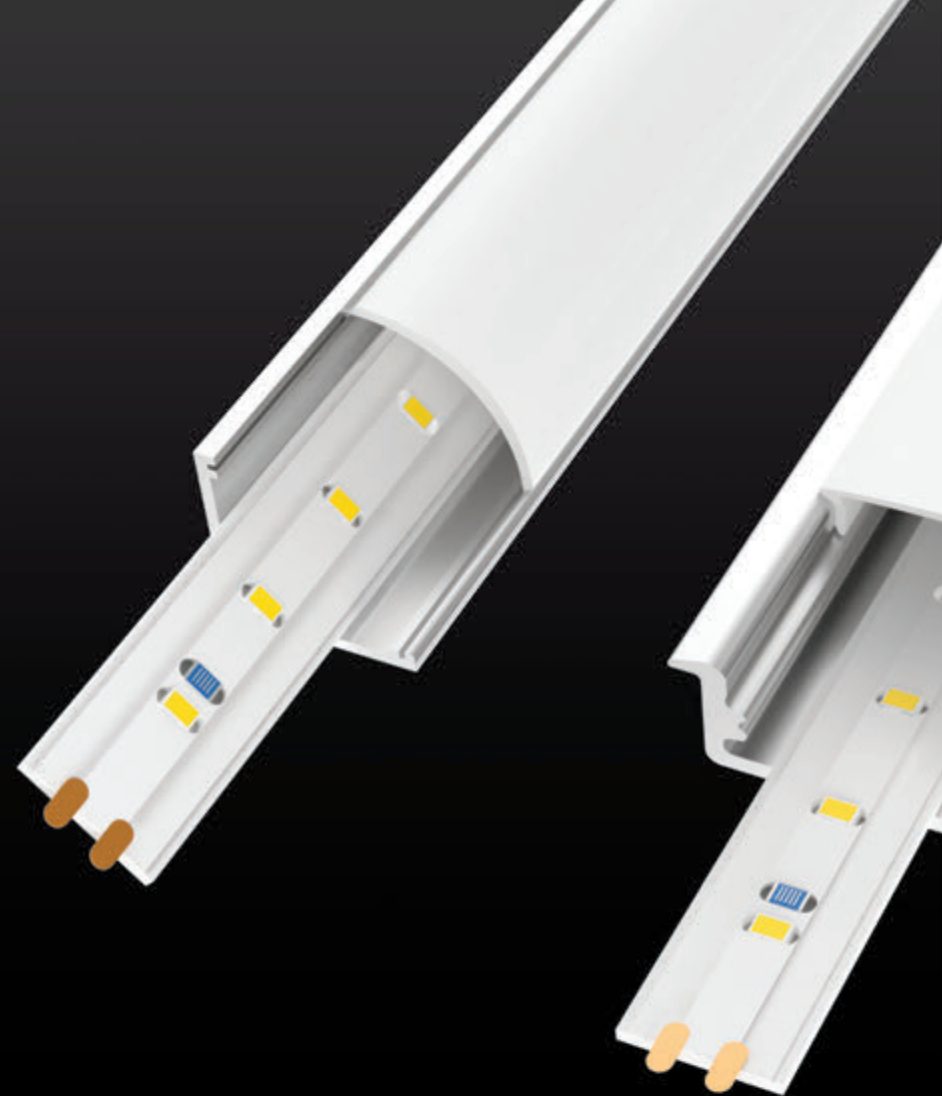



## Power sources recommended for use to connect Varton™ LED strip to the mains

Tm Meanwell power supply	IP LED tapes	Power source IP	Power W / m	Cut length
LRS-75-24	20	20	9,6	up to 5m
LRS-150-24	20	20	9,6	up to 10m
LRS-200-24	20	20	9,6	up to 15m
LPV-60-24	68	67	9,6	up to 5m
LPV-150-24	68	67	9,6	up to 10m
ELG-200-24A	68	67	9,6	up to 15m
LRS-100-24	20	20	14,4	up to 5m
LRS-200-24	20	20	14,4	up to 10m
LRS-350-24	20	20	14,4	up to 15m
LPV-100-24	68	67	14,4	up to 5m
ELG-200-24A	68	67	14,4	up to 10m



# NIMBUS

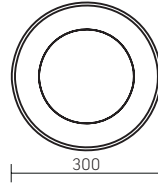

Lamp Size: 300x50 mm  
PF ≥0,95



Article	Power	Light temperature	Luminous flux	Color
V1-R0-00464-05000-4002540	25W	4000K	1800lm	RAL9010 White Matt
V1-R0-90464-05000-4002540	25W	4000K	1800lm	RAL9005 Black Matt

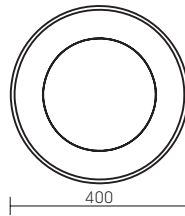
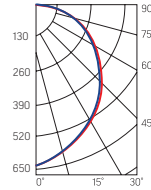

Lamp Size: 400x68 mm  
PF ≥0,95



Article	Power	Light temperature	Luminous flux	Color
V1-R0-00465-05000-4003540	35W	4000K	2800lm	RAL9010 White Matt
V1-R0-90465-05000-4003540	35W	4000K	2800lm	RAL9005 Black Matt

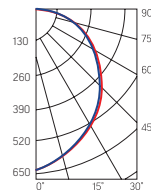

NEW MODEL



### Installation:

Lamps are installed on a flat horizontal or vertical surface (attachment included).  
Lamps can be mounted on hangers (a decorative set with cables is ordered separately).

### Case:

Aluminum

### Diffuser:

Opal diffuser included

### Specifications:

- Index of color transmission Ra > 83
- Temperature range from + 1 ° C to + 40 ° C
- AC220-240V
- Network frequency 50Hz +/- 10%
- LED life 50,000 hours
- 3 year warranty
- Luminous flux <5%
- Light angle 120 °
- UGR <22





## Accessories for NIMBUS lamps

Photo	Article	Name Mounting size
	V4-A0-70.0018.NMB-0001	Kit for the suspension of the lamp NIMBUS 25W white, cable length 1.5 m
	V4-A0-70.0018.NMB-0002	Set for suspension of the NIMBUS 25W lamp black, cable length 1.5 m
	V4-A0-70.0018.NMB-0003	Kit for the suspension of the lamp NIMBUS 35W white, cable length 1.5 m
	V4-A0-70.0018.NMB-0004	Set for suspension of the NIMBUS 35W lamp black, cable length 1.5 m



NEW  
MODEL



#### Installation

Built-in (clamping mounting system)

#### Case:

Aluminum

#### Diffuser:

Clear tempered glass

#### Specifications:

Index of color transmission  $R > 84$

Temperature range from  $+1^{\circ}\text{C}$  to  $+40^{\circ}\text{C}$

AC220-240V

Network frequency 50Hz  $\pm 10\%$

LED life 50,000 hours

3 year warranty

Luminous flux  $K_n < 5\%$

Light angle  $36^{\circ}$



## FLEX 50

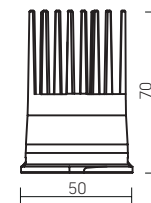

Lamp Size: 50x70 mm  
Package size of the lamp: 55x55x78 mm  
PF  $\geq 0,95$

Article

Power

Light  
temperature

Luminous  
flux

V1-R0-00435-10000-2001230 12W 3000K 1000 lm







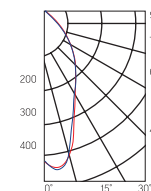



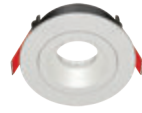

V1-R0-00435-10000-2001240 12W 4000K 1000 lm



● black

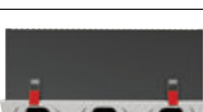

## REPLACEMENT FRAME FOR FLEX 50

Photo	Article	Name	Mounting size	Photo	Article	Name	Mounting size
	V1-R0-00435-10001-2000000	Frame for modular lamp FLEX 50 01 round built-in 90x30 mm RAL9010	Ø70 mm		V1-R0-00435-10002-2000000	Frame for modular lamp FLEX 50 08 square built-in 90x90x30 mm RAL9010RAL9010	70x70 mm
	V1-R0-00435-10003-2000000	Frame for modular lamp FLEX 50 02 round built-in 110x45 mm RAL9010 swivel	Ø90 mm		V1-R0-00435-10004-2000000	Frame for modular lamp FLEX 50 09 square built-in 110x110x45 mm RAL9010 swivel	90x90 mm
	V1-R0-00435-10005-2000000	Frame for a modular luminaire FLEX 50 03 built-in round recessed 85x65 mm RAL9010 swivel	Ø75 mm		V1-R0-00435-10006-2000000	Frame for the modular lamp FLEX 50 10 square built-in recessed 85x85x65 mm RAL9010 swivel	75x75 mm
	V1-R0-00435-10008-2000000	Frame for modular lamp FLEX 50 04 round built-in recessed 95x70 mm RAL9010	Ø90 mm		V1-R0-00435-10010-2000000	Frame for the modular lamp FLEX 50 11 double built-in 110x220x55 mm RAL9010 swivel	205x95 mm
	V1-R0-00435-10009-2000000	Frame for modular lamp FLEX 50 05 round built-in recessed 95x70 mm RAL9010 swivel	Ø90 mm		V1-R0-00435-10013-2000000	Frame for modular lamp FLEX 50 12 double built-in 110x220x130 mm RAL9010 swivel. Closed frame type for rooms with increased fire safety requirements	205x95 mm
	V1-R0-00435-10007-2000000	Frame for modular lamp FLEX 50 06 round built-in recessed 95x80 mm RAL9010 oblique light	Ø90 mm		V1-R0-00435-10011-2000000	Frame for modular luminaire FLEX 50 13 triple recessed 110x325x55 mm RAL9010 built-in	315x95 mm
	V1-R0-00435-10012-2000000	Frame for modular luminaire FLEX 50 07 round built-in recessed 110x48 mm RAL9010 swivel	Ø90 mm		V1-R0-00435-10014-2000000	Frame for the modular lamp FLEX 50 14 triple built-in 110x325x130 mm RAL9010 swivel. Closed frame type for rooms with increased fire safety requirements	315x95 mm



## WL-Cube IP54

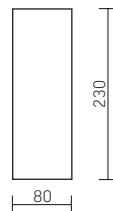

Lamp Size: 80×80×230 mm  
PF ≥0,90



● black

Article	Power	Light temperature	Luminous flux
V1-R5-90513-21000-5401030	10W	3000K	350 lm
V1-R5-90513-21000-5401040	10W	4000K	450 lm

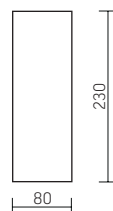
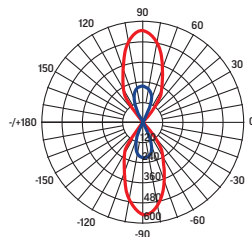

Lamp Size: 80×80×230 mm  
PF ≥0,90



○ white

Article	Power	Light temperature	Luminous flux
V1-R5-Y0513-21000-5401030	10W	3000K	350 lm
V1-R5-Y0513-21000-5401040	10W	4000K	450 lm

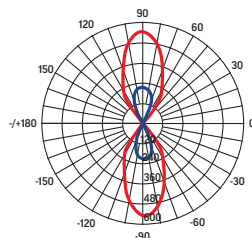

NEW  
MODEL

### Installation:

The lamp is installed on a flat vertical surface, fasteners are included in the package

### Case:

Aluminum

### Specifications:

Index of color transmission R > 83

Temperature range from -20 °C to + 40 °C

AC220-240V

Network frequency 50Hz +/- 10%

LED life 50,000 hours

3 year warranty

Luminous flux <5%

Angle of light 60 °



NEW  
MODEL



**Installation:**

The lamp is installed on a flat vertical surface, fasteners are included in the package

**Case:**

Aluminum

**Specifications:**

Index of color transmission  $R > 83$

Temperature range from  $-20^{\circ}\text{C}$  to  $+40^{\circ}\text{C}$

AC220-240V

Network frequency 50Hz  $\pm 10\%$

LED life 50,000 hours

3 year warranty

Luminous flux  $\times \text{Kn} < 5\%$

Angle of light  $60^{\circ}$



**WL-Tube IP54**

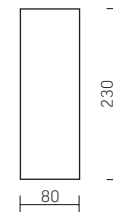

Lamp Size: 80x230 mm  
PF  $\geq 0,90$



● black

Article	Power	Light temperature	Luminous flux
V1-R5-90514-21000-5401030	10W	3000K	350 lm
V1-R5-90514-21000-5401040	10W	4000K	450 lm

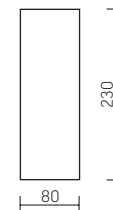
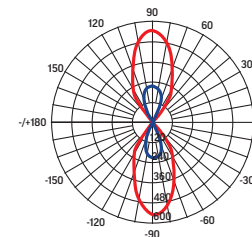

Lamp Size: 80x230 mm  
PF  $\geq 0,90$



○ white

Article	Power	Light temperature	Luminous flux
V1-R5-Y0514-21000-5401030	10W	3000K	350 lm
V1-R5-Y0514-21000-5401040	10W	4000K	450 lm

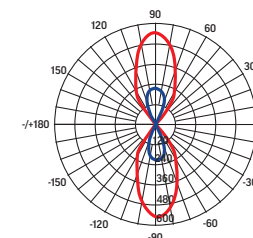



## TT-Mono

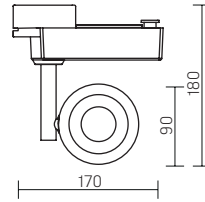

Lamp Size: 180×90×170 mm  
PF ≥0,85



Article	Power	Light temperature	Luminous flux
V1-R1-90482-90000-2001030	10W	3000K	900 lm
V1-R1-90482-90000-2001040	10W	4000K	1000 lm

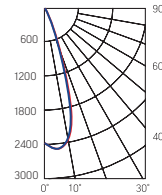

NEW MODEL



### Installation:

Integrated into a Varton™ 3-phase busbar

### Case:

Aluminum

### Specifications:

Index of color transmission R > 83

Temperature range from +1 °C to +40 °C

AC220-240V

Network frequency 50Hz +/- 10%

LED life 50,000 hours

3 year warranty

Luminous flux Kn < 5%

Light angle 35





**ACCENT LIGHTING**

NEW  
MODEL



**Installation:**

Integrated into a Varton™ 3-phase busbar

**Case:**

Aluminum

**Specifications:**

Index of color transmission R > 83

Temperature range from + 1 °C to + 40 °C

AC220-240V

Network frequency 50Hz +/- 10%

LED life 50,000 hours

3 year warranty

Luminous flux Kn < 5%



**TT-Vivo**

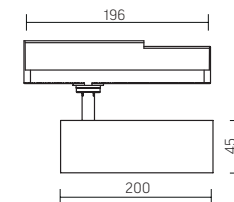

Lamp Size:  
196x200x45 mm  
PF ≥0,95



- white
- grey
- black

Article	Power	Light temperature	Luminous flux	Colour of case
V1-R1-Y0517-90XXX-2001030	10W	3000K	1000 lm	white
V1-R1-Y0517-90XXX-2001040	10W	4000K	1000 lm	grey
V1-R1-H0517-90XXX-2001030	10W	3000K	1000 lm	black
V1-R1-H0517-90XXX-2001040	10W	4000K	1000 lm	white
V1-R1-T0517-90XXX-2001030	10W	3000K	1000 lm	grey
V1-R1-T0517-90XXX-2001040	10W	4000K	1000 lm	black

XXX = R05 - angle 20°  
XXX = L02 - angle 30°  
XXX = R04 - angle 40°

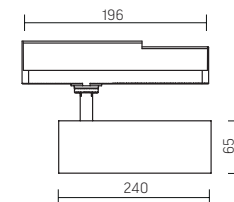
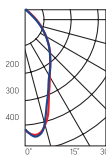

Lamp Size:  
196x240x65 mm  
PF ≥0,95

- white
- grey
- black

Article	Power	Light temperature	Luminous flux	Colour of case
V1-R1-Y0518-90XXX-2002030	20W	3000K	2000 lm	white
V1-R1-Y0518-90XXX-2002040	20W	4000K	2000 lm	grey
V1-R1-H0518-90XXX-2002030	20W	3000K	2000 lm	black
V1-R1-H0518-90XXX-2002040	20W	4000K	2000 lm	white
V1-R1-T0518-90XXX-2002030	20W	3000K	2000 lm	grey
V1-R1-T0518-90XXX-2002040	20W	4000K	2000 lm	black

XXX = R05 - angle 20°  
XXX = R06 - angle 35°

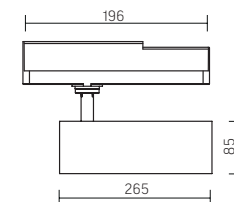
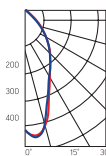

Lamp Size:  
196x265x85mm  
PF ≥0,95

- white
- grey
- black

Lamp Size:	Power	Light temperature	Luminous flux	Colour of case
V1-R1-Y0519-90XXX-2003030	30W	3000K	3000 lm	white
V1-R1-Y0519-90XXX-2003040	30W	4000K	3000 lm	grey
V1-R1-H0519-90XXX-2003030	30W	3000K	3000 lm	black
V1-R1-H0519-90XXX-2003040	30W	4000K	3000 lm	white
V1-R1-T0519-90XXX-2003030	30W	3000K	3000 lm	grey
V1-R1-T0519-90XXX-2003040	30W	4000K	3000 lm	black

XXX = R05 - angle 20°  
XXX = R06 - angle 35°

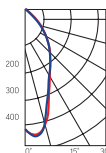

## TT-Vivo TrueBright

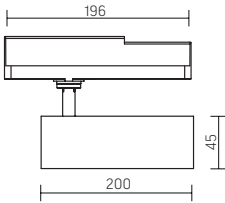

Lamp Size:  
196x200x45 mm  
PF ≥0,95



- white
- grey
- black

Article	Power	Light temperature	Luminous flux	Colour of case
V1-R1-Y0517-90XXX-2001030	10W	3000K	1000 lm	white
V1-R1-Y0517-90XXX-2001040	10W	4000K	1000 lm	grey
V1-R1-H0517-90XXX-2001030	10W	3000K	1000 lm	black
V1-R1-H0517-90XXX-2001040	10W	4000K	1000 lm	white
V1-R1-T0517-90XXX-2001030	10W	3000K	1000 lm	grey
V1-R1-T0517-90XXX-2001040	10W	4000K	1000 lm	black

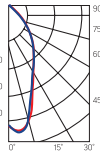

XXX = R07 - angle 20°  
XXX = L39 - angle 30°  
XXX = R09 - angle 40°

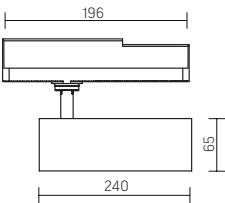

Lamp Size:  
196x240x65 mm  
PF ≥0,95

- white
- grey
- black

Article	Power	Light temperature	Luminous flux	Colour of case
V1-R1-Y0518-90XXX-2002030	20W	3000K	2000 lm	white
V1-R1-Y0518-90XXX-2002040	20W	4000K	2000 lm	grey
V1-R1-H0518-90XXX-2002030	20W	3000K	2000 lm	black
V1-R1-H0518-90XXX-2002040	20W	4000K	2000 lm	white
V1-R1-T0518-90XXX-2002030	20W	3000K	2000 lm	grey
V1-R1-T0518-90XXX-2002040	20W	4000K	2000 lm	black

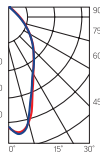

XXX = R07 - angle 20°  
XXX = R08 - angle 35°

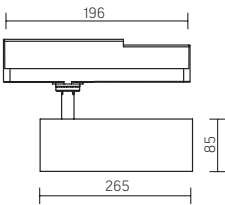

Lamp Size:  
196x265x85mm  
PF ≥0,95

- white
- grey
- black

Article	Power	Light temperature	Luminous flux	Colour of case
V1-R1-Y0519-90XXX-2003030	30W	3000K	3000 lm	white
V1-R1-Y0519-90XXX-2003040	30W	4000K	3000 lm	grey
V1-R1-H0519-90XXX-2003030	30W	3000K	3000 lm	black
V1-R1-H0519-90XXX-2003040	30W	4000K	3000 lm	white
V1-R1-T0519-90XXX-2003030	30W	3000K	3000 lm	grey
V1-R1-T0519-90XXX-2003040	30W	4000K	3000 lm	black

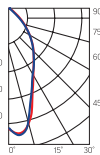

XXX = R07 - angle 20°  
XXX = R08 - angle 35°



NEW MODEL

### Installation:

Integrated into a Varton™ 3-phase busbar

### Case:

Aluminum

### Specifications:

Index of color transmission Ra > 92

Temperature range from +1 °C to +40 °C

AC220-240V

Network frequency 50Hz +/- 10%

LED life 50,000 hours

3 year warranty

Luminous flux Kn < 5%





**NEW MODEL**

## TT-Vivo Gold for lighting shelves with bakeries

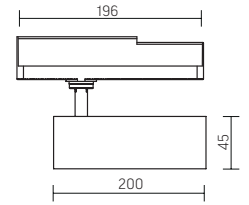

Lamp Size:  
196x200x45 mm  
PF ≥0.95



- white
- grey
- black

Lamp Size:	Power	Light temperature	Luminous flux	Colour of case
V1-R1-Y0517-90XXX-2001022	10W	2200K	800 lm	white
V1-R1-H0517-90XXX-2001022	10W	2200K	800 lm	black
V1-R1-T0517-90XXX-2001022	10W	2200K	800 lm	grey

XXX = R05 - angle 20°  
XXX = L02 - angle 30°  
XXX = R04 - angle 40°

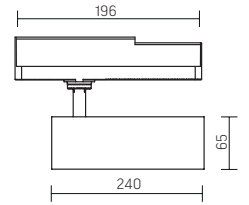
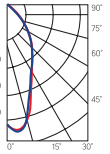

Lamp Size:  
196x240x65 mm  
PF ≥0.95

- white
- grey
- black

Lamp Size:	Power	Light temperature	Luminous flux	Colour of case
V1-R1-Y0518-90XXX-2002022	20W	2200K	1600 lm	white
V1-R1-H0518-90XXX-2002022	20W	2200K	1600 lm	black
V1-R1-T0518-90XXX-2002022	20W	2200K	1600 lm	grey

XXX = R05 - angle 20°  
XXX = R06 - angle 35°

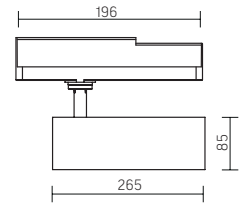
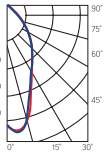

Lamp Size:  
196x265x85 mm  
PF ≥0.95

- white
- grey
- black

Lamp Size:	Power	Light temperature	Luminous flux	Colour of case
V1-R1-Y0519-90L02-2003022	30W	2200K	2400 lm	white
V1-R1-H0519-90L02-2003022	30W	2200K	2400 lm	black
V1-R1-T0519-90L02-2003022	30W	2200K	2400 lm	grey

XXX = R05 - angle 20°  
XXX = R06 - angle 35°

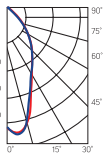

### Installation:

Integrated into a Varton™  
3-phase busbar

### Case:

Aluminum

### Specifications:

Index of color transmission Ra > 83  
Temperature range from + 1 ° C to + 40 ° C  
AC220-240V  
Network frequency 50Hz A +/- 10%  
LED life 50,000 hours  
3 year warranty  
Luminous flux Kn <5%



## TT-Vivo Marble lighting for shelves with meat products

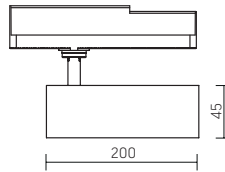

Lamp Size:  
196x200x45 mm  
PF ≥0.95



- white
- grey
- black

Lamp Size:	Power	Light temperature	Luminous flux	Colour of case
V1-R1-Y0517-90XXX-200103X	10W	3000K*	800 lm	white
V1-R1-H0517-90XXX-200103X	10W	3000K*	800 lm	black
V1-R1-T0517-90XXX-200103X	10W	3000K*	800 lm	grey

XXX = R05 - angle 20°  
XXX = L02 - angle 30°  
XXX = R04 - angle 40°

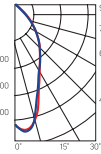

## TT-Vivo Ocean for lighting fish shelves

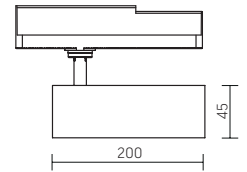

Lamp Size:  
196x200x45 mm  
PF ≥0.95



- white
- grey
- black

Lamp Size:	Power	Light temperature	Luminous flux	Colour of case
V1-R1-Y0517-90XXX-2001065	10W	6500K	1000 lm	white
V1-R1-H0517-90XXX-2001065	10W	6500K	1000 lm	black
V1-R1-T0517-90XXX-2001065	10W	6500K	1000 lm	grey

XXX = R05 - angle 20°  
XXX = L02 - angle 30°  
XXX = R04 - angle 40°

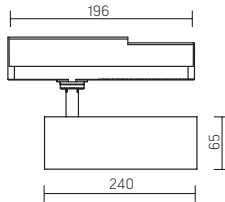
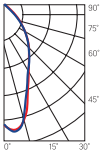

Lamp Size:  
196x240x65 mm  
PF ≥0.95

- white
- grey
- black

Lamp Size:	Power	Light temperature	Luminous flux	Colour of case
V1-R1-Y0518-90XXX-200203X	20W	3000K*	1600 lm	white
V1-R1-H0518-90XXX-200203X	20W	3000K*	1600 lm	black
V1-R1-T0518-90XXX-200203X	20W	3000K*	1600 lm	grey

XXX = R05 - angle 20°  
XXX = R06 - angle 35°

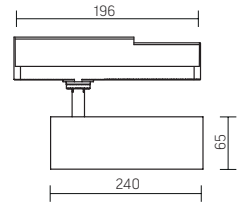
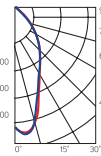

Lamp Size:  
196x240x65 mm  
PF ≥0.95

- white
- grey
- black

Lamp Size:	Power	Light temperature	Luminous flux	Colour of case
V1-R1-Y0518-90XXX-2002065	20W	6500K	2000 lm	white
V1-R1-H0518-90XXX-2002065	20W	6500K	2000 lm	black
V1-R1-T0518-90XXX-2002065	20W	6500K	2000 lm	grey

XXX = R05 - angle 20°  
XXX = R06 - angle 35°

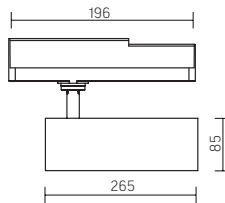
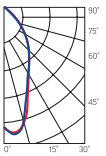

Lamp Size:  
196x265x85mm  
PF ≥0.95

- white
- grey
- black

Lamp Size:	Power	Light temperature	Luminous flux	Colour of case
V1-R1-Y0519-90XXX-200303X	30W	3000K*	2400 lm	white
V1-R1-H0519-90XXX-200303X	30W	3000K*	2400 lm	black
V1-R1-T0519-90XXX-200303X	30W	3000K*	2400 lm	grey

XXX = R05 - angle 20°  
XXX = R06 - angle 35°

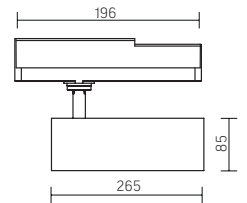
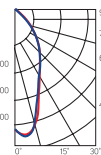

Lamp Size:  
196x265x85mm  
PF ≥0.95

- white
- grey
- black

Lamp Size:	Power	Light temperature	Luminous flux	Colour of case
V1-R1-Y0519-90XXX-2003065	30W	6500K	3000 lm	white
V1-R1-H0519-90XXX-2003065	30W	6500K	3000 lm	black
V1-R1-T0519-90XXX-2003065	30W	6500K	3000 lm	grey

XXX = R05 - angle 20°  
XXX = R06 - angle 35°

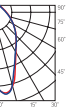

\*Light temperature 3000K with an offset spectrum for highlighting red color in the product.



# TT-01 2.0

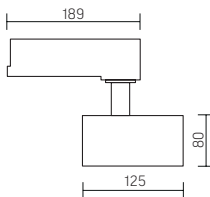

Lamp Size: 125x189x80 mm  
 Package size of the lamp:  
 197x175x85 mm  
 PF ≥0,90

Lamp Size:	Power	Light temperature	Luminous flux
V1-R0-00562-90XXX-2003030	30W	3000K	2900 lm
V1-R0-00562-90XXX-2003040	30W	4000K	3100 lm

XXX = L01 - angle 15°  
 XXX = R10 - angle 24°  
 XXX = L18 - angle 35°

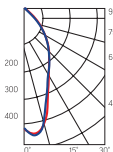

○ white

**NEW MODEL**



**Installation:**

Integrated into a Varton™ 3-phase busbar

**Case:**

Aluminum

**Specifications:**

Index of color transmission Ra > 83

Temperature range from + 1 ° C to + 40 ° C

AC220-240V

Network frequency 50Hz +/- 10%

LED life 50,000 hours

3 year warranty

Luminous flux Kn <5%



NEW  
MODEL



**Installation:**

Integrated into a Varton™ 3-phase busbar

**Case:**

Aluminum

**Specifications:**

Index of color transmission Ra > 83

Temperature range from + 1 ° C to + 40 ° C

AC220-240V

Network frequency 50Hz +/- 10%

LED life 50,000 hours

3 year warranty

Luminous flux <5%



**TT-02 2.0**

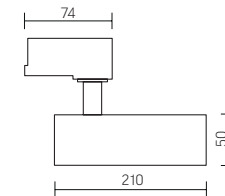

Lamp Size: 210x74x50 mm  
Package size of the lamp:  
220x80x60 mm  
PF ≥0,90



○ white

Article	Power	Light temperature	Luminous flux
V1-R0-00559-90XXX-2001230	12W	3000K	1000 lm
V1-R0-00559-90XXX-2001240	12W	4000K	1100 lm

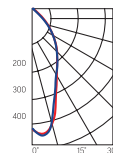

XXX = L01 - angle 15°  
XXX = R10 - angle 24°  
XXX = L18 - angle 35°

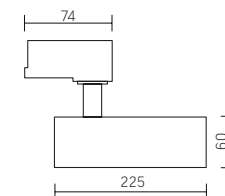

Lamp Size: 225x74x60 mm  
Package size of the lamp:  
275x90x90 mm  
PF ≥0,90

○ white

Article	Power	Light temperature	Luminous flux
V1-R0-00560-90L18-2002030	20W	3000K	1800 lm
V1-R0-00560-90L18-2002040	20W	4000K	2000 lm

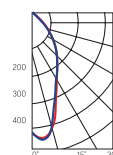

XXX = L01 - angle 15°  
XXX = R10 - angle 24°  
XXX = L18 - angle 35°

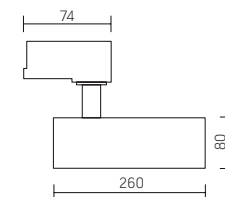

Lamp Size: 260x74x80 mm  
Package size of the lamp:  
275x90x90 mm  
PF ≥0,90

○ white

Article	Power	Light temperature	Luminous flux
V1-R0-00561-90XXX-2003030	30W	3000K	2900 lm
V1-R0-00561-90XXX-2003040	30W	4000K	3100 lm

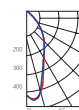

XXX = L01 - angle 15°  
XXX = R10 - angle 24°  
XXX = L18 - angle 35°





NEW  
MODEL



## TT-Stellar Comfort

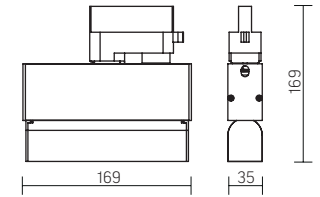

Lamp Size: 169×35×169 mm  
PF ≥0,95



● black

Article	Power	Light temperature	Luminous flux
V1-R0-90469-90L25-2001530	15W	3000K	1000 lm
V1-R0-90469-90L25-2001540	15W	4000K	1000 lm

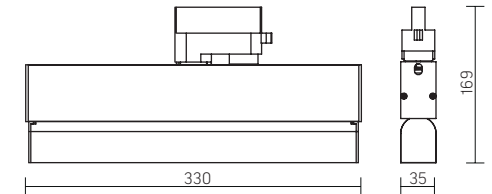
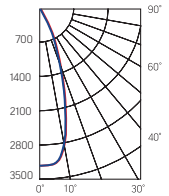

Lamp Size: 330×35×169 mm  
PF ≥0,95



● black

Article	Power	Light temperature	Luminous flux
V1-R0-90470-90L25-2002530	25W	3000K	2000 lm
V1-R0-90470-90L25-2002540	25W	4000K	2000 lm

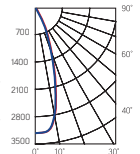

### Installation:

Integrated into a Varton™ 3-phase busbar

### Case:

Aluminum

### Specifications:

Index of color transmission Ra > 83

Temperature range from +1 °C to +40 °C

AC220-240V

Network frequency 50Hz +/- 10%

LED life 50,000 hours

3 year warranty

Luminous flux Kn <5%

Light angle 34 °

UGR <19





**Installation:**

Mounted on three-phase busbar  
Mount included

**Case:**

Aluminum

**Specifications:**

COB LED Modules

Index of color transmission Ra > 82

Temperature range from + 1 ° C to + 40 ° C

AC 220-240V

Network frequency 50Hz ± 10%

LED life 50,000 hours

3 year warranty

Luminous flux Kn ≤ 5%

Light angle 35 °



**TT-Prisma**

160×220×117,5mm

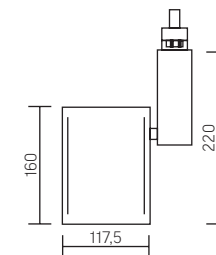

Lamp Size:  
205x165x265mm  
PF ≥ 0,9



● black

Article	Power	Light temperature	Luminous flux
V1-R0-90361-90L18-2003640	36W	4000K	2900lm
V1-R0-90361-90L18-2005040	50W	4000K	3800lm

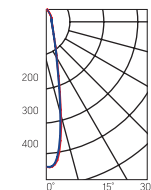

## TT-01

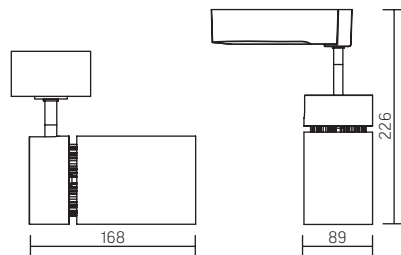

Lamp Size: 168x226x89mm  
 Package size of the lamp:  
 250x105x265 mm  
 PF ≥ 0,95



○ white

Article	Power	Light temperature	Luminous flux
V1-R0-00101-90000-2003230	32W	3000K	2800lm
V1-R0-00101-90000-2003240	32W	4000K	2800lm

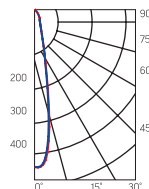

## TT-01

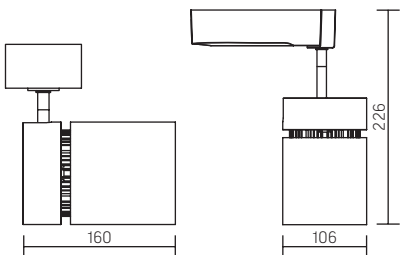

Lamp Size: 160x226x106mm  
 Package size of the lamp:  
 250x115x265mm  
 PF ≥ 0,95



○ white

Article	Power	Light temperature	Luminous flux
V1-R0-00102-90000-2005030	50W	3000K	3700lm
V1-R0-00102-90000-2005040	50W	4000K	3700lm

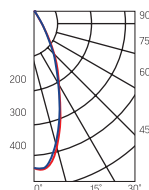

### Installation:

Mounted on three-phase busbar  
 Mount included

### Case:

Metal body (die casting) with white powder paint

### Specifications:

COB LED Modules

Index of color transmission Ra > 82

Temperature range from +1 °C to +40 °C

AC220-240V

Network frequency 50Hz ± 10%

LED life 50,000 hours

3 year warranty

Luminous flux ≤ 5%

The angle of the luminous flux 15° (32W)

The angle of the luminous flux 35° (50W)





**Installation:**

Mounted on three-phase busbar  
Mount included

**Case:**

Aluminum white powder coated

**Specifications:**

COB LED Modules

Index of color transmission Ra > 82

Temperature range from + 1 ° C to + 40 ° C

AC 220-240V

Network frequency 50Hz ± 10%

LED life 50,000 hours

3 year warranty

Luminous flux ≤ 5%

The angle of the luminous flux 35 ° (18W)

The angle of the luminous flux 24 ° (28W)



**TT-02**

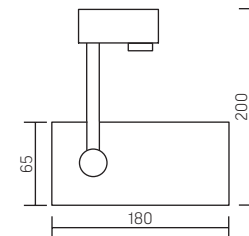

Lamp Size: 180x200x65mm

Package size of the lamp:

110x70x310mm

PF ≥ 0,9



○ white

Article	Power	Light temperature	Luminous flux
V1-R0-00112-90000-2001840	18W	4000K	1600lm

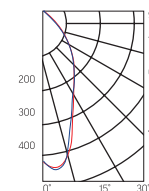

**TT-02**

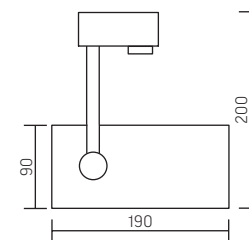

Lamp Size: 190x200x90mm

Package size of the lamp:

145x105x325mm

PF ≥ 0,9



○ white

Article	Power	Light temperature	Luminous flux
V1-R0-00112-90000-2002840	28W	4000K	2100lm

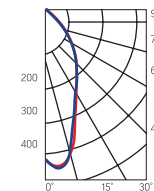

## Three-phase busbar Varton

### Installation:

Suspended cable installation  
Surface mounted on horizontal / vertical surface

### Case:

Aluminum body white / gray / black

### Specifications:

Maximum current per phase 16A  
Maximum voltage per phase 230V  
Maximum power per phase 3600W  
2 year warranty  
Available section lengths: 1m/2m/3m/4m \*\*  
\*\* if necessary, you can cut off shorter pieces when mounting the busbar  
Busbar is compatible with the series:  
Varton TT-01 (p. 61)  
Varton TT-02 (p. 62)  
Varton TT-Prisma (p. 58)

AC220-240V



### Scheme 1

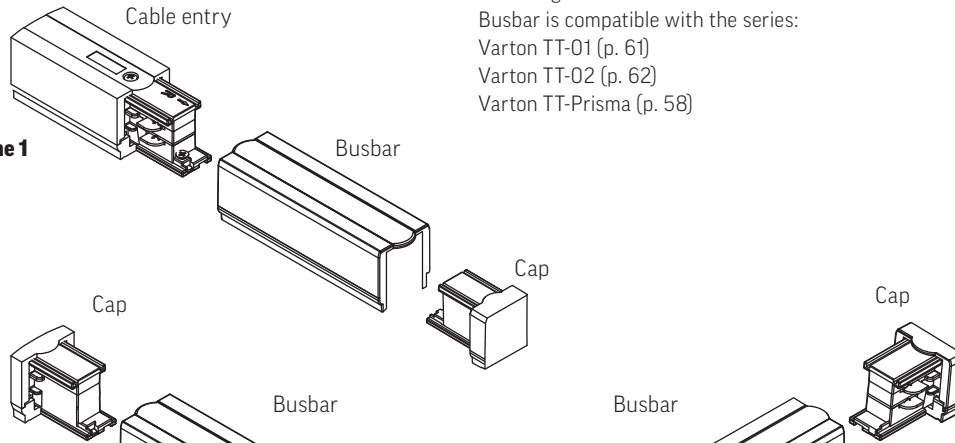

### Scheme 2

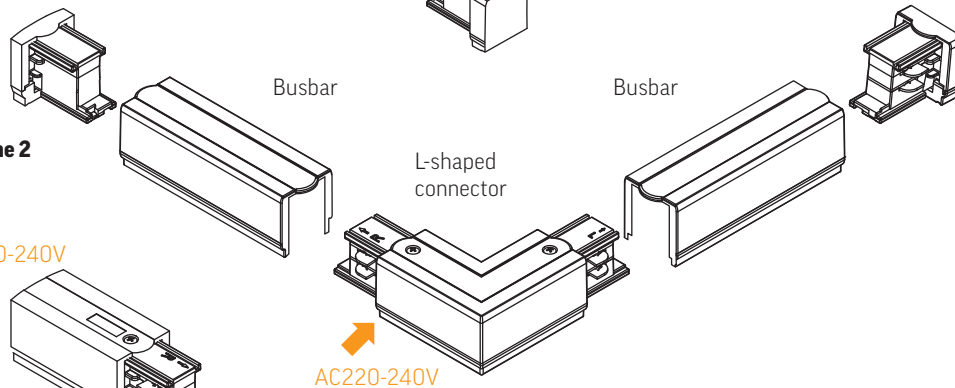

AC220-240V



### Scheme 3

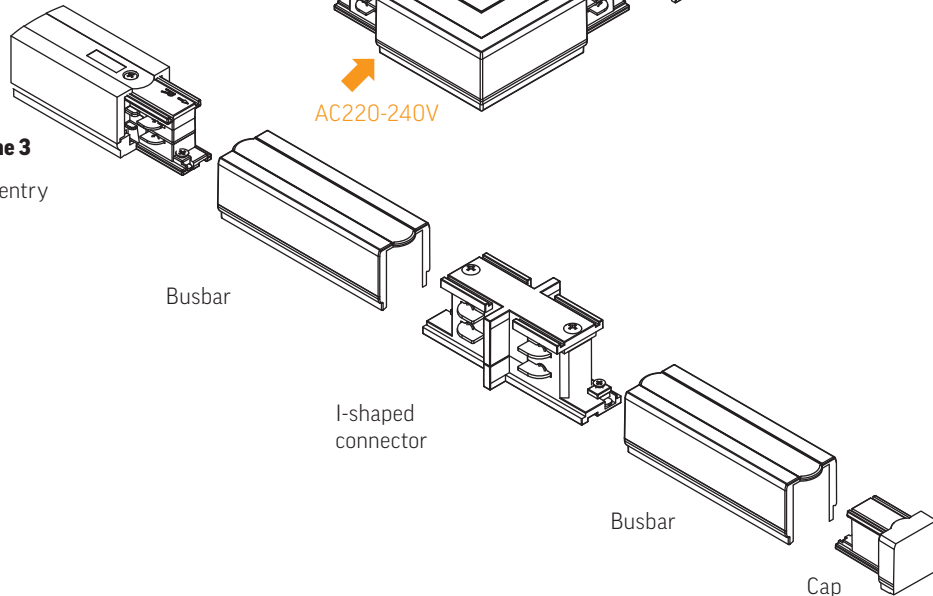

Busbar black



Busbar grey



Busbar white

Busbar white



V4-R4-00.0025.TRK-0001

white Cap



V4-R4-00.0024.TRK-0001

Cable entry left white (power supply)



V4-R4-00.0001.TRK-0001

Kit for surface mounting busbar white



V4-R4-00.0006.TRK-0001

Suspension kit with cable 1,5m white



V4-R4-00.0006.TRK-0002

Suspension kit with cable 3m white



V4-R4-00.0006.TRK-0003

Suspension kit with cable 5m white



	V4-R4-00.0012.TRK-0001	Suspension kit with cable 5m white
	V4-R4-00.0010.TRK-0001	Connector external L-shaped white left
Busbar white		
	V4-R4-00.0026.TRK-0001	Internal I-shaped white connector (connection of 2 busbars in a straight line)
	V4-R4-00.0010.TRK-0002	Internal L-shaped connector right white
	V4-R4-00.0027.TRK-0001	Flexible white connector
	V4-R4-00.0011.TRK-0001	Connector T-shaped left (external) white

Busbar black		
	V4-R4-05.0025.TRK-0001	Black cap
	V4-R4-05.0024.TRK-0001	Cable entry left black
	V4-R4-05.0024.TRK-0002	The kit for surface mounting busbar black
	V4-R4-05.0006.TRK-0001	Suspension kit with cable 1,5m black
	V4-R4-05.0006.TRK-0002	Suspension kit with cable 3m black
	V4-R4-05.0006.TRK-0003	Suspension kit with cable 5m black
	V4-R4-05.0026.TRK-0001	Suspension kit with cable 5m black
	V4-R4-05.0010.TRK-0002	Internal I-shaped black connector
	V4-R4-05.0012.TRK-0001	X-shaped connector black
	V4-R4-05.0010.TRK-0001	Connector external L-shaped black left
	V4-R4-05.0027.TRK-0001	Flexible black connector
	V4-R4-05.0011.TRK-0001	Connector T-shaped left (external) black
Busbar grey		
	V4-R4-70.0025.TRK-0001	Grey Cap
	V4-R4-70.0024.TRK-0001	Cable entry left grey
	V4-R4-70.0024.TRK-0002	The kit for surface mounting busbar grey
	V4-R4-70.0006.TRK-0001	Suspension kit with cable 1,5m grey
	V4-R4-70.0006.TRK-0002	Suspension kit with cable 3m grey
	V4-R4-70.0006.TRK-0003	Suspension kit with cable 5m grey
	V4-R4-70.0026.TRK-0001	Internal I-shaped grey connector
	V4-R4-70.0010.TRK-0002	Internal L-shaped connector right grey
	V4-R4-70.0012.TRK-0001	X-shaped connector grey
	V4-R4-70.0010.TRK-0001	Connector external L-shaped left grey
	V4-R4-70.0027.TRK-0001	Flexible connector grey
	V4-R4-70.0011.TRK-0001	Connector T-shaped left (external) grey

The number of kits for surface mounting / suspension of a busline is calculated using the formula: the number of meters of construction +1. For example, to install a straight busbar line with a length of 2m you will need 3 sets for surface mounting / suspension of a busline.

Maximum load on a busline mounted on suspensions: 150H / m.





**LINEAR RECESSED LUMINAIRES**

# UNIVERSAL-LINE

## Installation



Installation in Armstrong® suspended ceiling systems parallel to the rails

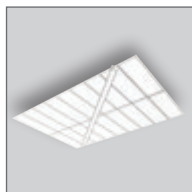

Installation into Armstrong® suspended ceiling systems diagonally to the rail



Installation in plasterboard ceilings and walls



Flexible Diffuser 25 meter

## Dimensions



860 mm



1145 mm



1430 mm



Other sizes multiple of 280 mm on request

## Version



DALI protocol dimming



Emergency version



Color Metal



RAL9010 white Matt





RAL9005 black Matt



Any color as per customer request

## Light temperature

-  3000K Warm white
-  4000K Neutral white
-  5000K Cold white
-  6500K Cold white

## Available capacities

**15W-80W**

Any size on request





NEW  
MODEL



**Installation:**

Embedded installation with Armstrong® suspended ceiling systems  
Installation in the gypsum board with mounting (ordered separately)

**Body Material:**

Aluminum

**Diffuser material:**

PC

**Specifications:**

Index of color transmission Ra > 82  
Temperature range from + 1 ° to + 40 ° C  
AC220-240V  
Network frequency 50Hz +/- 10%  
LED life 50,000 hours  
3 year warranty  
Luminous flux Kn < 5%



Universal-Line



Lamp Size: 890x100x69mm  
Mounting size: 868x85mm  
Package size of the lamp: 900x111x89mm  
PF ≥0,95



- metal
- white
- black

Article	Power	Light temperature	Luminous flux	Colour of case:
V1-A1-70413-10000-4002030	20W	3000K	2000 lm	metal
V1-A1-70413-10000-4002040	20W	4000K	2000 lm	metal
V1-A1-70413-10000-4003830	30W	3000K	3000 lm	metal
V1-A1-70413-10000-4003840	30W	4000K	3000 lm	metal
V1-A1-W0413-10000-4002030	20W	3000K	2000 lm	white RAL 9003 Matt
V1-A1-W0413-10000-4002040	20W	4000K	2000 lm	white RAL 9003 Matt
V1-A1-W0413-10000-4003030	30W	3000K	3000 lm	white RAL 9003 Matt
V1-A1-W0413-10000-4003040	30W	4000K	3000 lm	white RAL 9003 Matt
V1-A1-90413-10000-4002030	20W	3000K	2000 lm	black RAL 9005 Matt
V1-A1-90413-10000-4002040	20W	4000K	2000 lm	black RAL 9005 Matt
V1-A1-90413-10000-4003030	30W	3000K	3000 lm	black RAL 9005 Matt
V1-A1-90413-10000-4003040	30W	4000K	3000 lm	black RAL 9005 Matt



Lamp Size: 1176x100x69mm  
Mounting size: 1153x85mm  
Package size of the lamp: 1200x111x89mm  
PF ≥0,95



- metal
- white
- black

Article	Power	Light temperature	Luminous flux	Colour of case:
V1-A1-70414-10000-4002130	21W	3000K	2100 lm	metal
V1-A1-70414-10000-4002140	21W	4000K	2100 lm	metal
V1-A1-70414-10000-4005030	36W	3000K	3600 lm	metal
V1-A1-70414-10000-4005040	36W	4000K	3600 lm	metal
V1-A1-00414-10000-4002130	21W	3000K	2100 lm	white RAL 9003 Matt
V1-A1-00414-10000-4002140	21W	4000K	2100 lm	white RAL 9003 Matt
V1-A1-00414-10000-4005030	36W	3000K	3600 lm	white RAL 9003 Matt
V1-A1-00414-10000-4005040	36W	4000K	3600 lm	white RAL 9003 Matt
V1-A1-90414-10000-4002130	21W	3000K	2100 lm	black RAL 9005 Matt
V1-A1-90414-10000-4002140	21W	4000K	2100 lm	black RAL 9005 Matt
V1-A1-90414-10000-4003630	36W	3000K	3600 lm	black RAL 9005 Matt
V1-A1-90414-10000-4003640	36W	4000K	3600 lm	black RAL 9005 Matt

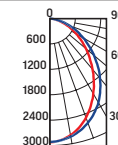
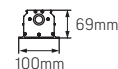
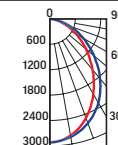

## Universal-Line



Lamp Size: 1460x100x69mm  
 Mounting size: 1438x85mm  
 Package size of the lamp:  
 1500x111x89mm  
 PF ≥ 0,95







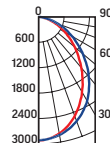

- metal
- white
- black

Article	Power	Light temperature	Luminous flux	Colour of case:
V1-A1-70415-10000-4002230	22W	3000K	2200 lm	metal
V1-A1-70415-10000-4002240	22W	4000K	2200 lm	metal
V1-A1-70415-10000-4006230	46W	3000K	4600 lm	metal
V1-A1-70415-10000-4006240	46W	4000K	4600 lm	metal
V1-A1-00415-10000-4002230	22W	3000K	2200 lm	white RAL 9003 Matt
V1-A1-00415-10000-4002240	22W	4000K	2200 lm	white RAL 9003 Matt
V1-A1-00415-10000-4006230	46W	3000K	4600 lm	white RAL 9003 Matt
V1-A1-00415-10000-4006240	46W	4000K	4600 lm	white RAL 9003 Matt
V1-A1-90415-10000-4002230	22W	3000K	2200 lm	black RAL 9005 Matt
V1-A1-90415-10000-4002240	22W	4000K	2200 lm	black RAL 9005 Matt
V1-A1-90415-10000-4004630	46W	3000K	4600 lm	black RAL 9005 Matt
V1-A1-90415-10000-4004640	46W	4000K	4600 lm	black RAL 9005 Matt

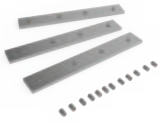

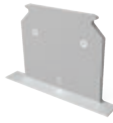
## Accessories for Universal-Line

	Article	Power
	V2-R0-0P00-02.0.0109.00	Flexible opal PC diffuser, 25m roll
	V2-R0-0P00-02.0.0110.00	Flexible opal PC diffuser, roll 12.2m
	V4-R0-70.0007.UL0-0003	Mounting kit for mounting in-line Universal-Line luminaire (3 plates and screws)
	V4-R0-70.0007.UL0-0004	Mount for horizontal and vertical embedded mounting Universal-Line
	V4-R0-70.0007.UL0-0001	Cover end deaf to Universal-Line lamp, width 15mm
	V4-R0-70.0007.UL0-0002	Cover end with sealed lead for lamp Universal-Line, width 15mm





**G-Line**  
1170×128×80mm

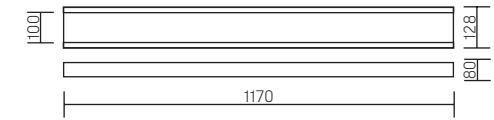

Package size of the lamp:  
1208×133×91mm  
Mounting size: 1188×110mm  
PF ≥ 0,95



Article	Power	Light temperature	Luminous flux
V1-R0-70034-80000-2001830	18W	3000K	1900lm
V1-R0-70034-80000-2001840	18W	4000K	2000lm
V1-R0-70034-80000-2001865	18W	6500K	2100lm
V1-R0-70034-80000-2003630	36W	3000K	3800lm
V1-R0-70034-80000-2003640	36W	4000K	3900lm
V1-R0-70034-80000-2003665	36W	6500K	4100lm
V1-R0-70034-80000-2005430	54W	3000K	5700lm
V1-R0-70034-80000-2005440	54W	4000K	5800lm
V1-R0-70034-80000-2005465	54W	6500K	6000lm

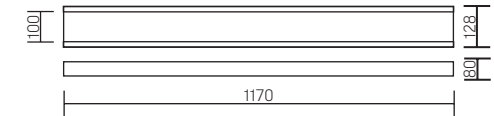
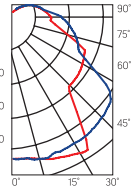

Package size of the lamp:  
1208×133×91mm  
PF ≥ 0,95

○ white

Article	Power	Light temperature	Luminous flux
V1-R0-00034-80000-2001830	18W	3000K	1900lm
V1-R0-00034-80000-2001840	18W	4000K	2000lm
V1-R0-00034-80000-2001865	18W	6500K	2100lm
V1-R0-00034-80000-2003630	36W	3000K	3800lm
V1-R0-00034-80000-2003640	36W	4000K	3900lm
V1-R0-00034-80000-2003665	36W	6500K	4100lm
V1-R0-00034-80000-2005430	54W	3000K	5700lm
V1-R0-00034-80000-2005440	54W	4000K	5800lm
V1-R0-00034-80000-2005465	54W	6500K	6000lm

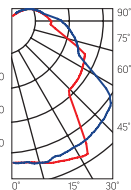

**Installation:**  
Due to the clamping system, the luminaires can easily be built into plasterboard ceilings  
T-shaped, L-shaped and X-shaped light turns provide a continuous uniform line without unlit areas  
Luminaire dimensions are not including end covers

**Case:**  
Complete with all types of diffusers  
Luminaire housing made of anodized aluminum profile

**Application:**  
Suitable for various types of ceilings (plasterboard, Gilyato, etc.)

**Specifications:**  
Index of color transmission Ra > 80  
Temperature range from + 1 ° C to + 40 ° C  
AC176-264V  
Network frequency 50Hz ± 10%  
LED life 50,000 hours  
3 year warranty  
Luminous flux Kn ≤ 1%



Diffuser  
Diffuser (optional)  
Pack size of diffuser (2 pcs.):  
1208×105×18mm

Article	Type	Diffuser size
V2-R0-PR00-02.2.0031.25	Prism standard	1174×95mm
V2-R0-OP00-03.2.0031.15	Opal	1174×95mm
V2-R0-PS00-00.2.0031.20	Pin spot	1174×95mm
V2-R0-CI00-00.2.0031.20	Crushed ice	1174×95mm
V2-R0-MP00-02.2.0031.20	Microprism	1174×95mm

\* Luminous Flux Set excluding the diffuser



## G-Line

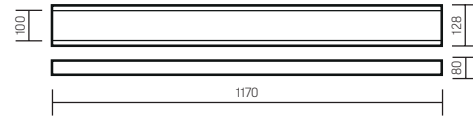

### DALI

Package size of the lamp:  
1208×133×91mm  
PF ≥ 0,95

○ metal

Article	Power	Light temperature	Luminous flux *
V1-R0-70034-80D01-2003630	36W	3000K	3800lm
V1-R0-70034-80D01-2003640	36W	4000K	3900lm
V1-R0-70034-80D01-2003665	36W	6500K	4100lm
V1-R0-70034-80D01-2005430	54W	3000K	5700lm
V1-R0-70034-80D01-2005440	54W	4000K	5800lm
V1-R0-70034-80D01-2005465	54W	6500K	6000lm

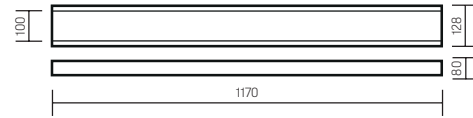
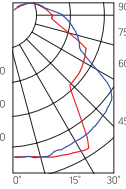

### DALI

Package size of the lamp:  
1208×133×91mm  
PF ≥ 0,95

○ white

Article	Power	Light temperature	Luminous flux *
V1-R0-00034-80D01-2003630	36W	3000K	3800lm
V1-R0-00034-80D01-2003640	36W	4000K	3900lm
V1-R0-00034-80D01-2003665	36W	6500K	4100lm
V1-R0-00034-80D01-2005430	54W	3000K	5700lm
V1-R0-00034-80D01-2005440	54W	4000K	5800lm
V1-R0-00034-80D01-2005465	54W	6500K	6000lm
V4-R0-70.0007.GL0-0001		closed-type end cap	
V4-R0-70.0008.GL0-0001		End cap with sealed lead-in	
V4-R0-00.0007.GL0-0002		closed-type end cap (white)	
V4-R0-00.0008.GL0-0002		End cap with sealed lead-in (white)	

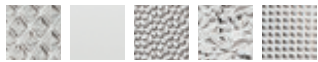
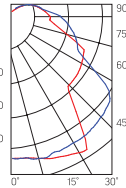

Diffuser (optional)  
Pack size of diffuser (2 pcs.):  
1208×105×18mm

Article	Type	Diffuser size
V2-R0-PR00-02.2.0031.25	Prism standard	1174×95mm
V2-R0-ME00-03.2.0031.15	Opal	1174×95mm
V2-R0-PS00-00.2.0031.20	Pin spot	1174×95mm
V2-R0-CI00-00.2.0031.20	Crushed ice	1174×95mm
V2-R0-MP00-02.2.0031.20	Microprism	1174×95mm

\* Luminous Flux Set excluding the diffuser

## G-Line connectors

Colour of case: ○ ○

Light temperature: 30000K/4000K/6500K



L-connector 18W, 36W, 54W

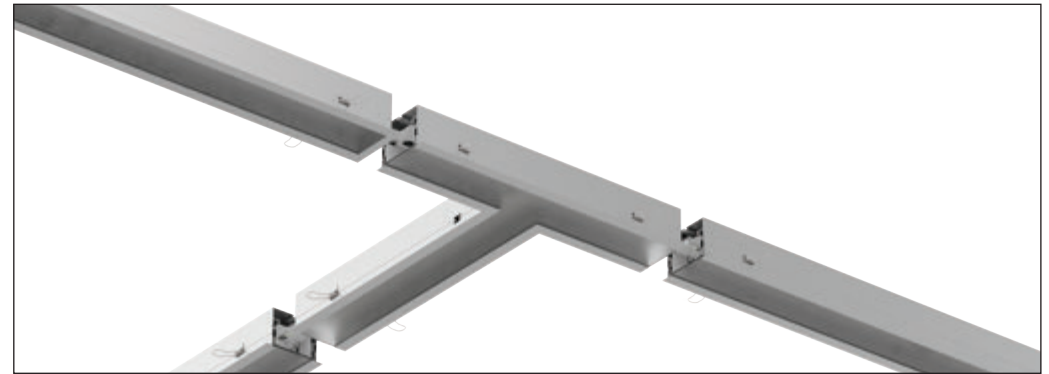

T-connector 18W, 36W, 54W

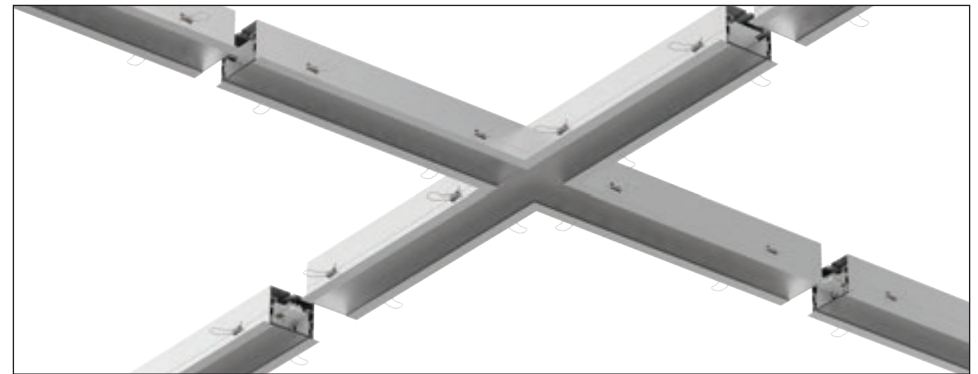

X-connector 36W, 72W, 108W





**LINEAR SUSPENDED LUMINAIRES**

# MERCURY IP54

Linear Luminaires  
Aluminum extrusion body  
IP54

## Installation



## Dimensions

**20W**

**30W**

740×54×58 mm

**32W**

**39W**

**57W**

1095×54×58 mm

**42W**

**52W**

**76W**

1450×54×58 mm

**63W**

**78W**

**114W**

2160×54×58 mm

## Version



DALI protocol dimming



Emergency version

## Optics

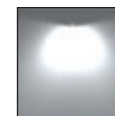

89°x115°

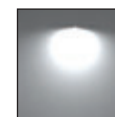

Opal Diffuser

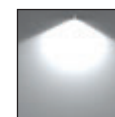

Clear Diffuser

## Light temperature

-  3000K  
Warm white
-  4000K  
Neutral white
-  5000K  
Cold white



## MERCURY MALL IP54

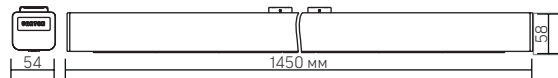

AC198-264V  
PF ≥ 0,98



- white
- metal

Article	Dimensions	Power, W	Luminous flux, Lm	Diffuser		
V1-R0-70380-31000-5402040	740x54x58	20	2740	Clear		
V1-R0-70380-31000-5403040		30	3870			
V1-R0-70380-31G02-5405240		20	2260	Opal		
V1-R0-70380-31G02-5407640		30	3150			
V1-R0-70380-31L12-5405240		20	2540	Lens 89°x115		
V1-R0-70380-31L12-5407640		30	3600			
V1-R0-70380-31000-5404240	1095x54x58	32	4640	Clear		
V1-R0-70380-31000-540520		40	5480			
V1-R0-70380-31000-5407640		57	7353			
V1-R0-70380-31G02-5404240		32	3808		Opal	
V1-R0-70380-31G02-5405240		40	4520			
V1-R0-70380-31G02-5407640		57	5985			
V1-R0-70380-31L12-5404240		32	4256	Lens 89°x115		
V1-R0-70380-31L12-5405240		40	5080			
V1-R0-70380-31L12-5407640		57	6840			
V1-R0-70380-31000-5404240		1450x54x58	42		6100	Clear
V1-R0-70380-31000-5405240			52		7100	
V1-R0-70380-31000-5407640			76		9800	
V1-R0-70380-31G02-5404240	42		5000	Opal		
V1-R0-70380-31G02-5405240	52		5900			
V1-R0-70380-31G02-5407640	76		8000			
V1-R0-70380-31L12-5404240	42		5600		Lens 89°x115	
V1-R0-70380-31L12-5405240	52		6600			
V1-R0-70380-31L12-5407640	76		9100			
V1-R0-70380-31000-5404240	2160x54x58		63	9135		Clear
V1-R0-70380-31000-540520			78	10686		
V1-R0-70380-31000-5407640			114	14706		
V1-R0-70380-31G02-5404240		63	7497	Opal		
V1-R0-70380-31G02-5405240		78	8814			
V1-R0-70380-31G02-5407640		114	11970			
V1-R0-70380-31L12-5404240		63	8379		Lens 89°x115	
V1-R0-70380-31L12-5405240		78	9906			
V1-R0-70380-31L12-5407640		114	13680			

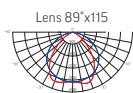

### Accessories for the lamp Mercury IP54 (ordered separately)

Photo	Article	
	V4-R0-70.0009.MIP-0001	Line Connection Kit
	V4-R0-00.0024.MIP-0001	Set of connectors for waterproof wire connections

NEW  
MODEL



#### Installation:

Suspended installation  
Surface Mounted through side covers

#### Material:

Aluminium case  
Plastic side covers

#### Specifications:

Index of color transmission Ra > 80  
Temperature range from +1 ° to +45 ° C  
LED life 50,000 hours  
3 year warranty  
Luminous flux Kn ≤ 3%



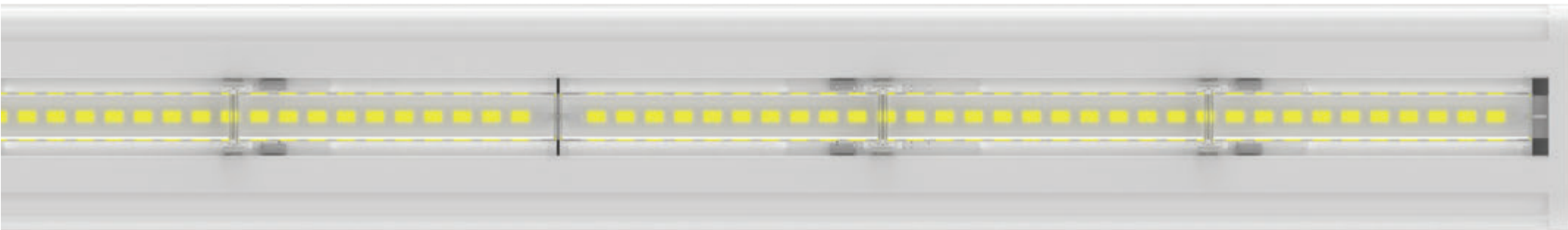

# Mercury LED Mall

Linear Luminaires  
Aluminum extrusion body IP23

## Installation

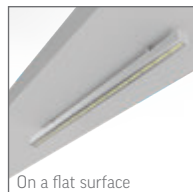

## Dimensions

**18W** **36W** **48W**



885x66x58 mm

**22W** **36W** **44W** **62W**



1170x66x58 mm

**22W** **44W** **56W** **80W**



1460x66x58 mm

**40W** **80W** **112W**



2026x66x58 mm

## Version



DALI protocol dimming



Emergency version

## Optics

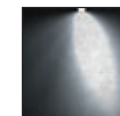
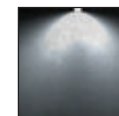
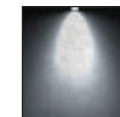
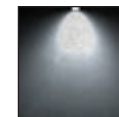

## Light temperature

- 3000K Warm white
- 4000K Neutral white







## Mercury LED Mall

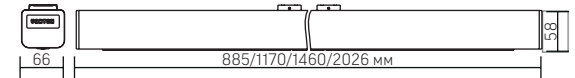
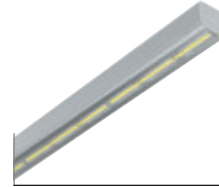

AC176-264V  
PF ≥ 0,97

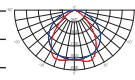
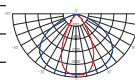

○ metal

Article	Dimensions	Power, W	Light temperature	Luminous flux, Lm	Light distribution curve
V1-R0-70429-31L12-2303640	885x66x58	36	4000K	5100	89°x115° 
V1-R0-70429-31L12-2303630		36	3000K	4900	
V1-R0-70429-31L12-2304840		48	4000K	6300	
V1-R0-70429-31L12-2304830		48	3000K	6000	
V1-R0-70430-31L12-2303640	1170x66x58	36	4000K	5200	
V1-R0-70430-31L12-2303630		36	3000K	4900	
V1-R0-70430-31L12-2304440		44	4000K	6300	
V1-R0-70430-31L12-2304430		44	3000K	6000	
V1-R0-70430-31L12-2306240	1460x66x58	62	4000K	8100	
V1-R0-70430-31L12-2306230		62	3000K	7800	
V1-R0-70150-31L12-2304440		44	4000K	6300	
V1-R0-70150-31L12-2304430		44	3000K	6000	
V1-R0-70150-31L12-2305640	2026x66x58	56	4000K	8000	
V1-R0-70150-31L12-2305630		56	3000K	7600	
V1-R0-70150-31L12-2308040		80	4000K	10500	
V1-R0-70150-31L12-2308030		80	3000K	10000	
V1-R0-70431-31L12-2308040	885x66x58	80	4000K	11500	58°x121° 
V1-R0-70431-31L12-2308030		80	3000K	10900	
V1-R0-70431-31L12-2311240		112	4000K	16000	
V1-R0-70431-31L12-2311230		112	3000K	15200	
V1-R0-70429-31L13-2303640	885x66x58	36	4000K	5500	
V1-R0-70429-31L13-2303630		36	3000K	5200	
V1-R0-70429-31L13-2304840		48	4000K	6800	
V1-R0-70429-31L13-2304830		48	3000K	6400	
V1-R0-70430-31L13-2303640	1170x66x58	36	4000K	5600	
V1-R0-70430-31L13-2303630		36	3000K	5300	
V1-R0-70430-31L13-2304440		44	4000K	6700	
V1-R0-70430-31L13-2304430		44	3000K	6400	
V1-R0-70430-31L13-2306240	1460x66x60	62	4000K	8800	
V1-R0-70430-31L13-2306230		62	3000K	8300	
V1-R0-70150-31L13-2304440		44	4000K	6800	
V1-R0-70150-31L13-2304430		44	3000K	6500	
V1-R0-70150-31L13-2305640	2026x66x58	56	4000K	8500	
V1-R0-70150-31L13-2305630		56	3000K	8100	
V1-R0-70150-31L13-2308040		80	4000K	11300	
V1-R0-70150-31L13-2308030		80	3000K	10700	
V1-R0-70431-31L13-2308040	885x66x58	80	4000K	12400	
V1-R0-70431-31L13-2308030		80	3000K	11800	
V1-R0-70431-31L13-2311240		112	4000K	17000	
V1-R0-70431-31L13-2311230		112	3000K	16200	

### Installation:

Mounting on suspensions, mounting on a flat surface, as well as the possibility of assembly in a line

### Case:

Aluminum anodized body

### Specifications:

Index of color transmission Ra > 80

Temperature range from + 1 ° C to + 40 ° C

Network frequency 50Hz ± 10%

LED life 50,000 hours

3 year warranty

Luminous flux Kn ≤ 1%



# Mercury LED Mail

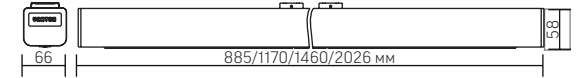
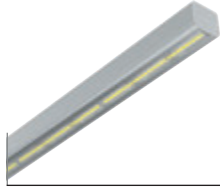

Article	Dimensions	Power, W	Light temperature	Luminous flux, Lm	Light distribution curve	Article	Dimensions	Power, W	Light temperature	Luminous flux, Lm	Light distribution curve	Article	Dimensions	Power, W	Light temperature	Luminous flux, Lm	Light distribution curve	
V1-R0-70429-31L14-2303640	885x66x58	36	4000K	5000	92°x35°	V1-R0-70429-31L16-2303640	885x66x58	36	4000K	5000	Asymmetry	V1-R0-70429-31G02-2303630	885x66x58	36	3000K	3800	NEW MODEL	
V1-R0-70429-31L14-2303630		36	3000K	4800		V1-R0-70429-31L16-2303630		36	3000K	4800		V1-R0-70429-31G02-2303640		36	4000K	4100		
V1-R0-70429-31L14-2304840		48	4000K	6200		V1-R0-70429-31L16-2304840		48	4000K	6200		V1-R0-70429-31G02-2304830		48	3000K	4700		Opal Diffuser
V1-R0-70429-31L14-2304830		48	3000K	5900		V1-R0-70429-31L16-2304830		48	3000K	5900		V1-R0-70429-31G02-2304840		48	4000K	5000		
V1-R0-70430-31L14-2303640	1170x66x58	36	4000K	5100	V1-R0-70430-31L16-2303640	1170x66x58	36	4000K	5100	V1-R0-70430-31G02-2303630	1170x66x58	36	3000K	3900	Opal Diffuser			
V1-R0-70430-31L14-2303630		36	3000K	4800	V1-R0-70430-31L16-2303630		36	3000K	4800	V1-R0-70430-31G02-2303640		36	4000K	4100				
V1-R0-70430-31L14-2304440		44	4000K	6100	V1-R0-70430-31L16-2304440		44	4000K	6100	V1-R0-70430-31G02-2304430		44	3000K	4700				
V1-R0-70430-31L14-2304430		44	3000K	5800	V1-R0-70430-31L16-2304430		44	3000K	5800	V1-R0-70430-31G02-2304440		44	4000K	5000				
V1-R0-70430-31L14-2306240	1460x66x65	62	4000K	8000	V1-R0-70430-31L16-2306240	1460x66x69	62	4000K	8000	V1-R0-70430-31G02-2306230	1460x66x58	62	3000K	6100	Opal Diffuser			
V1-R0-70430-31L14-2306230		62	3000K	7600	V1-R0-70430-31L16-2306230		62	3000K	7600	V1-R0-70430-31G02-2306240		62	4000K	6400				
V1-R0-70150-31L14-2304440		44	4000K	6200	V1-R0-70150-31L16-2304440		44	4000K	6200	V1-R0-70150-31G02-2304430		44	3000K	4800				
V1-R0-70150-31L14-2304430		44	3000K	5900	V1-R0-70150-31L16-2304430		44	3000K	5900	V1-R0-70150-31G02-2304440		44	4000K	5000				
V1-R0-70150-31L14-2305640	2026x66x58	56	4000K	7800	V1-R0-70150-31L16-2305640	2026x66x58	56	4000K	7800	V1-R0-70150-31G02-2305630	2026x66x58	56	3000K	6000	Opal Diffuser			
V1-R0-70150-31L14-2305630		56	3000K	7400	V1-R0-70150-31L16-2305630		56	3000K	7400	V1-R0-70150-31G02-2305640		56	4000K	6300				
V1-R0-70150-31L14-2308040		80	4000K	10300	V1-R0-70150-31L16-2308040		80	4000K	10300	V1-R0-70150-31G02-2308030		80	3000K	7900				
V1-R0-70150-31L14-2308030		80	3000K	9800	V1-R0-70150-31L16-2308030		80	3000K	9800	V1-R0-70150-31G02-2308040		80	4000K	8300				
V1-R0-70431-31L14-2308040	1170x66x58	80	4000K	11300	V1-R0-70431-31L16-2308040	1170x66x58	80	4000K	11300	V1-R0-70431-31G02-2308030	1170x66x58	80	3000K	8600	Opal Diffuser			
V1-R0-70431-31L14-2308030		80	3000K	10700	V1-R0-70431-31L16-2308030		80	3000K	10700	V1-R0-70431-31G02-2308040		80	4000K	9000				
V1-R0-70431-31L14-2311240		112	4000K	15600	V1-R0-70431-31L16-2311240		112	4000K	15600	V1-R0-70431-31G02-2311230		112	3000K	11100				
V1-R0-70431-31L14-2311230		112	3000K	14800	V1-R0-70431-31L16-2311230		112	3000K	14800	V1-R0-70431-31G02-2311240		112	4000K	11600				
V1-R0-70429-31L15-2303640	885x66x58	36	4000K	4600	V1-R0-70429-31L17-2303640	885x66x58	36	4000K	5000	Narrow asymmetry	V1-R0-70429-31L17-2303630	885x66x58	36	4000K	4700	Oblique light		
V1-R0-70429-31L15-2303630		36	3000K	4400	V1-R0-70429-31L17-2303630		36	3000K	4700		V1-R0-70429-31L17-2303640		36	3000K	4400			
V1-R0-70429-31L15-2304840		48	4000K	5700	V1-R0-70429-31L17-2304840		48	4000K	6000		V1-R0-70429-31L17-2304830		48	3000K	5700			
V1-R0-70429-31L15-2304830		48	3000K	5400	V1-R0-70429-31L17-2304830		48	3000K	5700		V1-R0-70430-31L15-2303640		36	4000K	5000			
V1-R0-70430-31L15-2303640	1170x66x58	36	4000K	4700	V1-R0-70430-31L17-2303640	1170x66x58	36	4000K	5000	V1-R0-70430-31L17-2303630	1170x66x58	36	3000K	4700	Opal Diffuser			
V1-R0-70430-31L15-2303630		36	3000K	4400	V1-R0-70430-31L17-2303630		36	3000K	4700	V1-R0-70430-31L17-2304440		44	4000K	6100				
V1-R0-7043031L15-2304440		44	4000K	5700	V1-R0-70430-31L17-2304440		44	4000K	6100	V1-R0-70430-31L17-2304430		44	3000K	5700				
V1-R0-70430-31L15-2304430		44	3000K	5300	V1-R0-70430-31L17-2304430		44	3000K	5700	V1-R0-70430-31L17-2306240		62	4000K	7800				
V1-R0-70430-31L15-2306240	1460x66x66	62	4000K	7400	V1-R0-70430-31L17-2306240	1460x66x72	62	4000K	7800	V1-R0-70430-31L17-2306230	1460x66x58	62	3000K	7400	Opal Diffuser			
V1-R0-70430-31L15-2306230		62	3000K	7000	V1-R0-70430-31L17-2306230		62	3000K	7400	V1-R0-70150-31L15-2304440		44	4000K	5700				
V1-R0-70150-31L15-2304440		44	4000K	5700	V1-R0-70150-31L17-2304440		44	4000K	6100	V1-R0-70150-31L15-2304430		44	3000K	5400				
V1-R0-70150-31L15-2304430		44	3000K	5400	V1-R0-70150-31L17-2304430		44	3000K	5800	V1-R0-70150-31L15-2305640		56	4000K	7200				
V1-R0-70150-31L15-2305640	2026x66x58	56	4000K	7200	V1-R0-70150-31L17-2305640	2026x66x58	56	4000K	7700	V1-R0-70150-31L17-2305630	2026x66x58	56	3000K	6800	Opal Diffuser			
V1-R0-70150-31L15-2305630		56	3000K	6800	V1-R0-70150-31L17-2305630		56	3000K	7300	V1-R0-70150-31L15-2308040		80	4000K	9500				
V1-R0-70150-31L15-2308040		80	4000K	9500	V1-R0-70150-31L17-2308040		80	4000K	10000	V1-R0-70150-31L15-2308030		80	3000K	9000				
V1-R0-70150-31L15-2308030		80	3000K	9000	V1-R0-70150-31L17-2308030		80	3000K	9500	V1-R0-70431-31L15-2308040		80	4000K	10400				
V1-R0-70431-31L15-2308040	1170x66x58	80	4000K	10400	V1-R0-70431-31L17-2308040	1170x66x58	80	4000K	11100	V1-R0-70431-31L17-2308030	1170x66x58	80	3000K	10500	Opal Diffuser			
V1-R0-70431-31L15-2308030		80	3000K	9800	V1-R0-70431-31L17-2308030		80	3000K	10500	V1-R0-70431-31L17-2311240		112	4000K	15400				
V1-R0-70431-31L15-2311240		112	4000K	14400	V1-R0-70431-31L17-2311240		112	4000K	15400	V1-R0-70431-31L15-2311230		112	3000K	13600				
V1-R0-70431-31L15-2311230		112	3000K	13600	V1-R0-70431-31L17-2311230		112	3000K	14600									



Accessories for the lamp Mercury LED Mall

Delivered with luminaire



Closed-type end cap (2pcs)  
Article: V4-R0-00.0007.MM0-0001



Suspension mount (3pcs)  
Article: V4-R0-00.0004.MM0-0001

Supplementary accessories for ordering

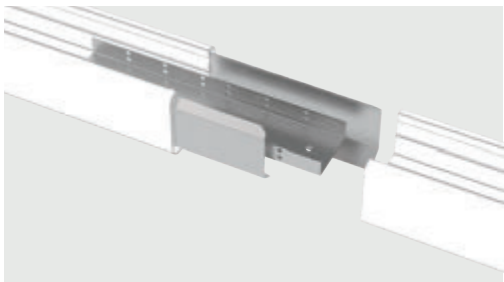

Line Connection Kit  
Article: V4-R0-00.0009.MM0-0001



Suspension kit  
1000mm Article: V4-R0-00.0027.MM0-0001  
Suspension kit  
2000mm Article: V4-R0-00.0027.MM0-0002  
Suspension kit  
4000mm Article: V4-R0-00.0027.MM0-0003



Three-phase continuous wiring  
Article: V4-R0-00.0026.MM0-0001



Universal adapter is designed to connect lamps in complex lighting structures such as L, T and X  
1. Universal adapter for L, T, X-connections of luminaires of the Mercury LED Mall series  
Article: V4-R0-00.0024.MM0-0001  
2. Adapter with connector for series of luminaires Mercury LED Mall type 1  
Article: V4-R0-00.0023.MM0-0001  
3. Adapter with connector for luminaires Mercury LED Mall type 2  
Article: V4-R0-00.0023.MM0-0002



NEW  
MODEL



## Supermarket

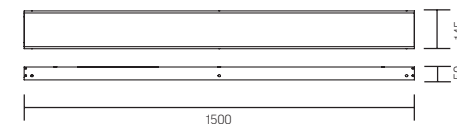

Lamp Size:  
1500x145x50mm  
Package size of the lamp:  
1577x155x62mm  
PF≥0,97



○ white

Article	Power	Light temperature	Luminous flux*
V1-R0-00341-31000-4004040	40W	4000K	4900 lm
V1-R0-00341-31000-4008040	80W	4000K	9800 lm

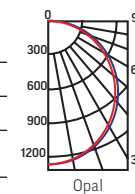

### Accessories for the Supermarket lamp (supplied separately)

V4-R0-00.0006.SU0-0001	Suspension kit for lamps of the Supermarket series (2 pcs included)
V4-R0-00.0007.SU0-0001	End cap with a connector for connecting lamps of the Supermarket series (2 pcs included)
V4-R0-00.0009.SU0-0001	Plate connecting with a set of fastenings for lamps of the Supermarket series (2 pieces in a set)
V4-R0-00.0010.SU0-0001	Connector L-shaped with a set of fixtures for lamps of the Supermarket series
V4-R0-00.0011.SU0-0001	Connector T-shaped with a set of fixtures for lamps of the Supermarket series
V4-R0-00.0012.SU0-0001	Connector X-shaped with a set of fixtures for lamps of the Supermarket series Prism

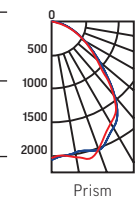

### Installation:

Mounting on suspensions, mounting on a flat surface, as well as the possibility of assembly in line.

T-shaped, L-shaped and X-shaped light turns provide the ability to assemble complex geometric shapes.

### Body Material:

Sheet steel coated with white powder paint

### Specifications:

Index of color transmission Ra > 80  
Temperature range from + 1° to + 40 °C  
Input voltage: AC176-264V  
LED life 50,000 hours  
3 year warranty  
Luminous flux Kn ≤ 1%

### Diffusers (supplied separately, 2 pcs per pack)



Article	Type	Diffuser size
V2-R0-PR00-00.2.0028.25	Prism standart	1499x140 мм
V2-R0-OP00-00.2.0028.25	Opal	1499x140 мм

\* Luminous Flux Set excluding the diffuser



## Accessories Lamp Supermarket

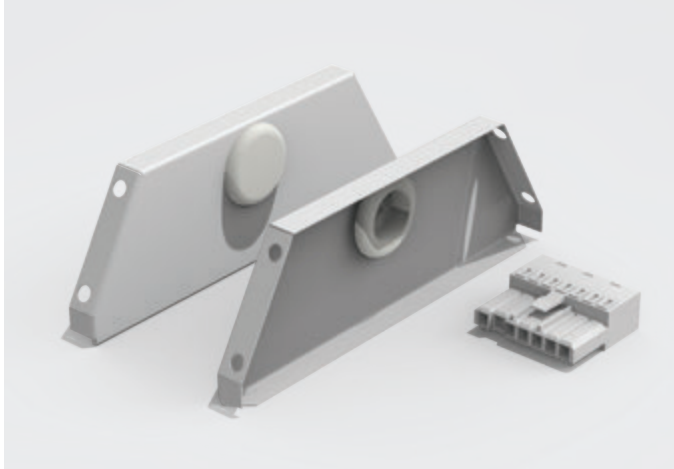

V4-R0-00.0007.SU0-0001

End cap with connector for connecting lamps of the Supermarket series (2 pieces in the set)

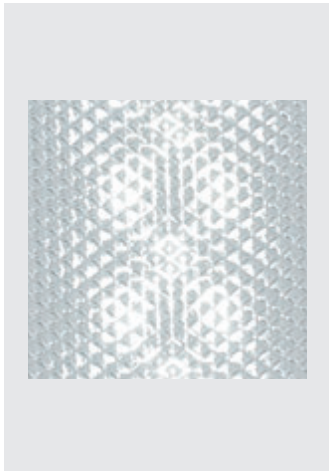

V2-R0-PR00-00.2.0028.25  
Prism standard Diffuser for Supermarket  
1500x145 (1499x140 mm), 2 pcs per pack

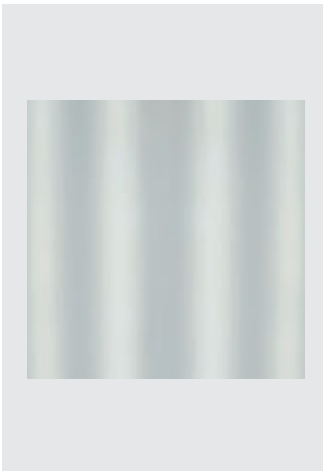

V2-R0-OP00-00.2.0028.25  
Opal diffuser for Supermarket 1500x145  
(1499x140 mm) 2 pcs per pack

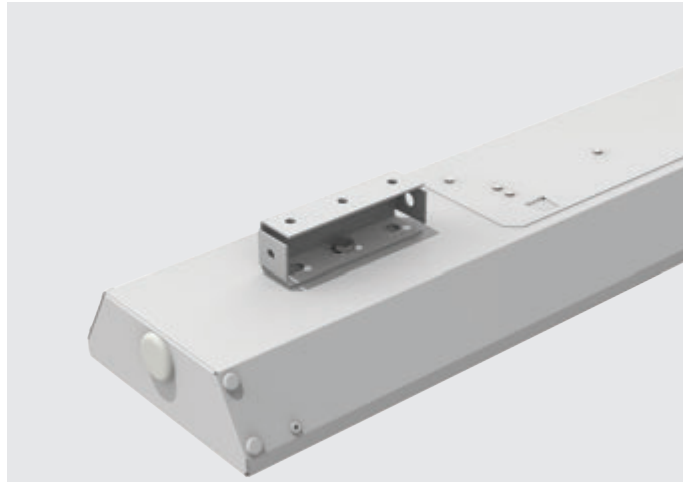

V4-R0-00.0006.SU0-0001

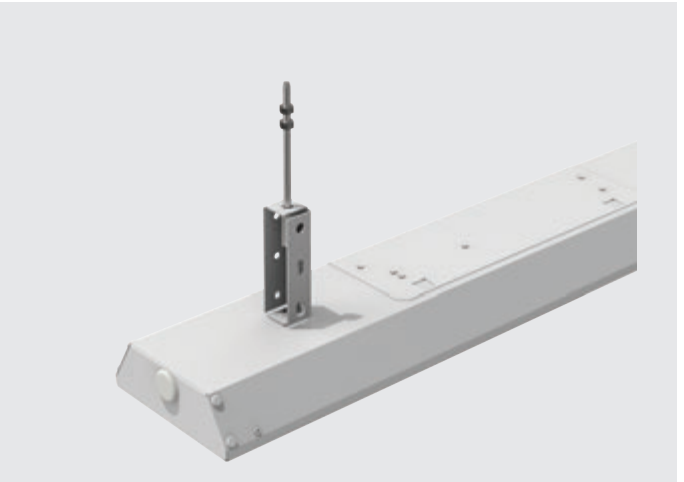

Suspension kit for lamps of the Supermarket series (2 pieces in the set)

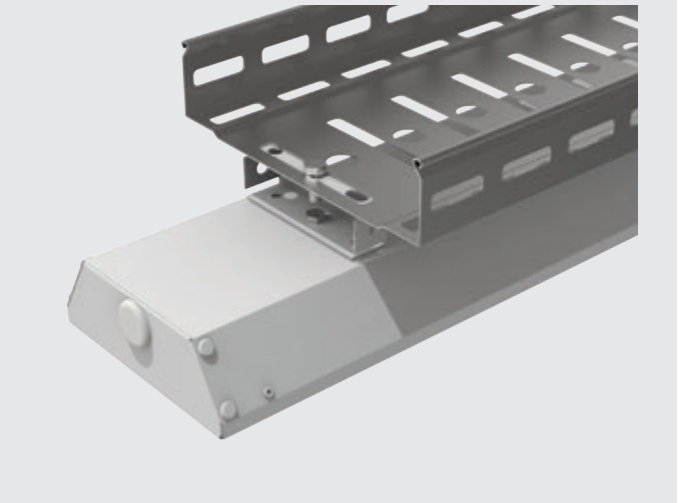
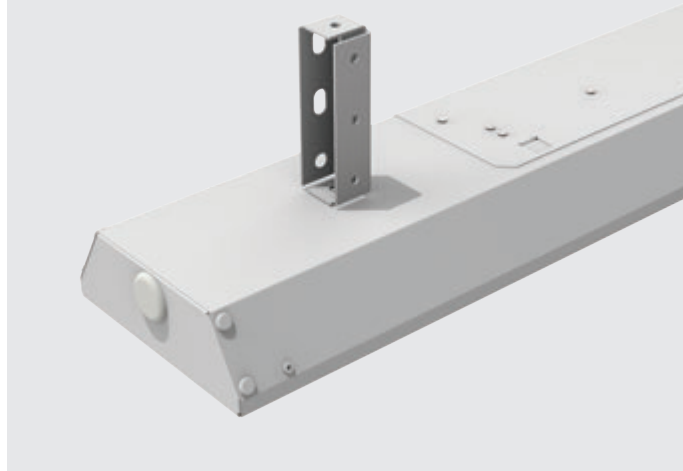

## Connectors Supermarket lamp

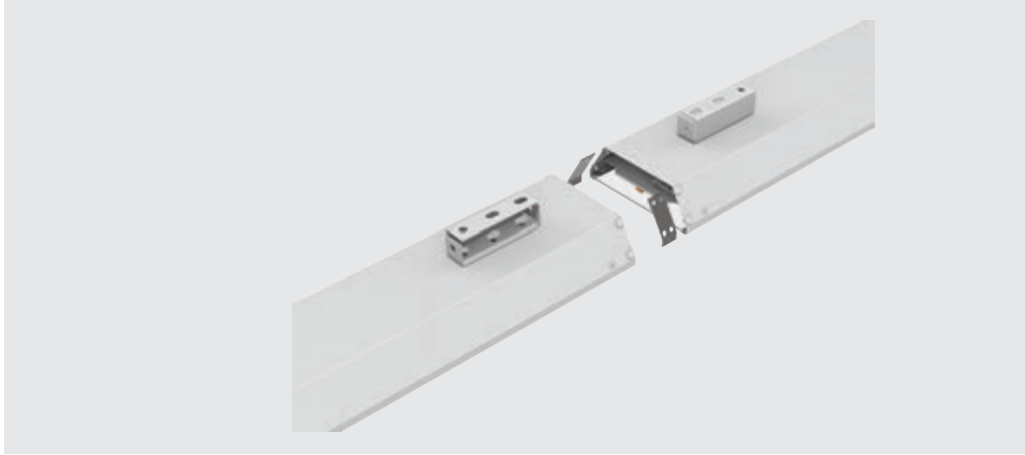

V4-R0-00.0009.SU0-0001  
Plate connection with a set of fixtures for Supermarket series lamps (2 pcs included)



V4-R0-00.0010.SU0-0001  
Connector L-shaped with a set of fixtures for lamps of the Supermarket series

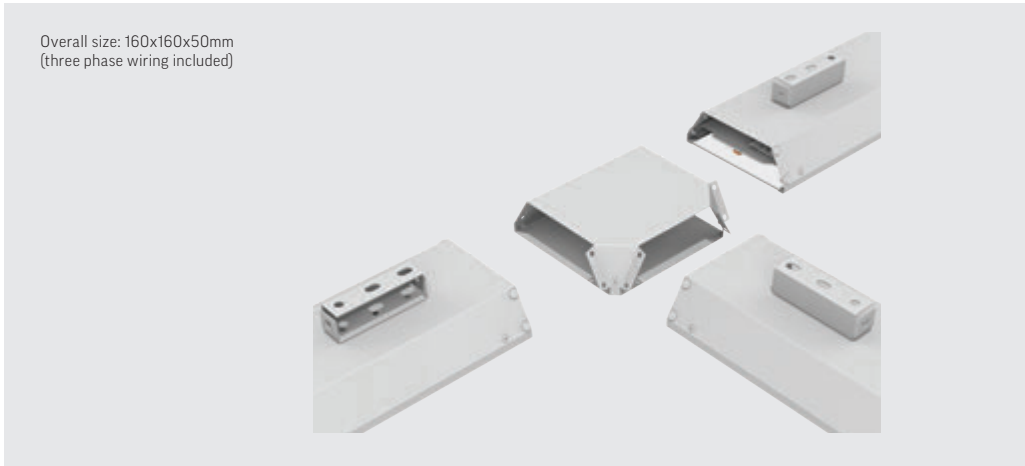

V4-R0-00.0011.SU0-0001  
Connector T-shaped with a set of fixtures for lamps Supermarket series

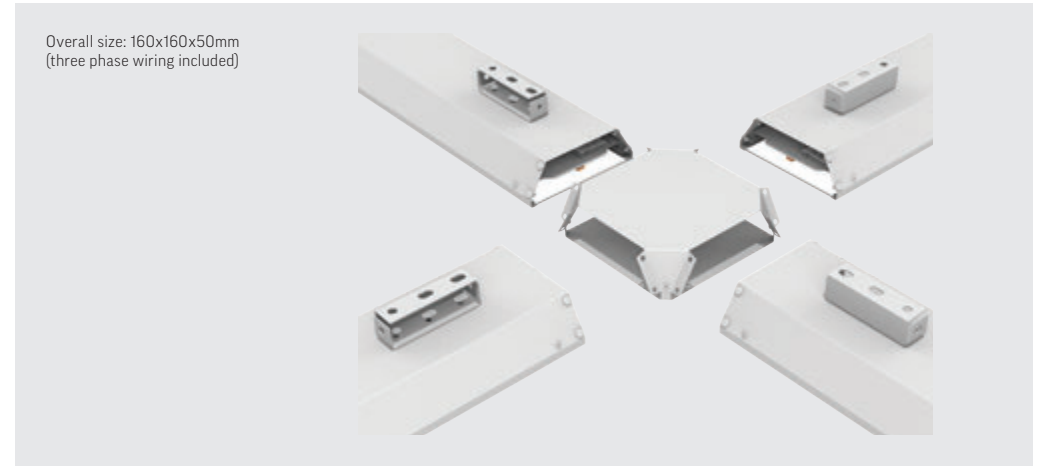

V4-R0-00.0012.SU0-0001  
Connector X-shaped with a set of fixtures for lamps Supermarket series





**LINEAR SUSPENDED/  
COVER LAMPS**

## Stellar-Line Opal

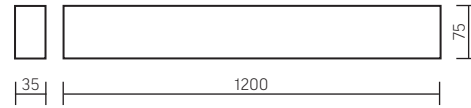

Lamp Size: 1200x35x75mm  
 Package size of the lamp:  
 1210x40x80 mm  
 PF ≥0,95



● black ○ white

Article	Power	Light temperature	Luminous flux*	
V1-R0-T0493-05000-2003630	36W	3000K	2900 lm	RAL9005 black Matt
V1-R0-W0493-05000-2003630	36W	3000K	2900 lm	RAL9010 white Matt
V1-R0-T0493-05000-2003640	36W	4000K	2900 lm	RAL9005 black Matt
V1-R0-W0493-05000-2003640	36W	4000K	2900 lm	RAL9010 white Matt

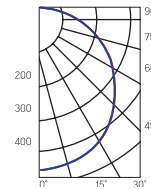

## Accessories for Stellar-Line

Article	Name
V4-R0-T0.0006.SL0-0001	Suspension kit for Stellar-Line luminaires, length 1.2 m RAL9005 black matte
V4-R0-W0.0006.SL0-0001	Suspension kit for Stellar-Line luminaires, length 1.2 m RAL9010 white matt

### Installation:

Lamps are installed on a flat horizontal or vertical surface (attachment included)

Luminaires can be mounted on hangers (a decorative set with cables is ordered separately)

### Body Material:

Aluminum

### Diffuser:

Opal diffuser included

### Specifications:

Index of color transmission Ra > 83

Temperature range from + 1 ° C to + 40 ° C

AC220-240V

Network frequency 50Hz +/- 10%

LED life 50,000 hours

3 year warranty

Luminous flux Kn <5%

Light angle 120 °

UGR <22







## Stellar-Line Comfort

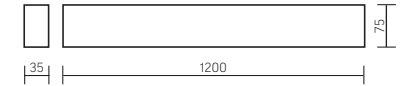

Lamp Size: 1200x35x75 mm  
 Package size of the lamp:  
 1210x40x80 mm  
 PF ≥0,95



● black ○ white

Article	Power	Light temperature	Luminous flux*	
V1-R0-T0493-05L21-2003630	36W	3000K	2900 lm	RAL9005 black matt
V1-R0-W0493-05L21-2003630	36W	3000K	2900 lm	RAL9010 white matt
V1-R0-T0493-05L21-2003640	36W	4000K	2900 lm	RAL9005 black matt
V1-R0-W0493-05L21-2003640	36W	4000K	2900 lm	RAL9010 white matt

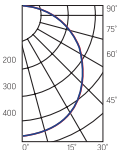

## Stellar-Line Comfort Up'n'Down

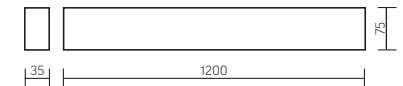

Lamp Size: 1200x35x75 mm  
 Package size of the lamp:  
 1210x40x80 mm  
 PF ≥0,95



● black ○ white

Article	Power	Light temperature	Luminous flux*	
V1-R0-T0493-05L21-2005630	56W	3000K	5700 lm	RAL9005 black matt
V1-R0-W0493-05L21-2005630	56W	3000K	5700 lm	RAL9010 white matt
V1-R0-T0493-05L21-2005640	56W	4000K	5700 lm	RAL9005 black matt
V1-R0-W0493-05L21-2005640	56W	4000K	5700 lm	RAL9010 white matt

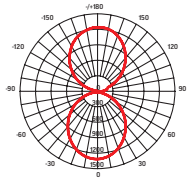

### Installation:

Lamps are installed on a flat horizontal or vertical surface (attachment included)

Lamps can be mounted on hangers (a decorative set with cables is ordered separately). Up'n'Down fixtures are installed only on hangers, suspension kit is included in delivery

### Body Material:

Aluminum

### Specifications:

Index of color transmission Ra > 83

Temperature range from +1 °C to +40 °C

AC220-240V

Network frequency 50Hz +/- 10%

LED life 50,000 hours

3 year warranty

Luminous flux Kn <5%

Light beam angle 50 °

UGR <10



## Accessories for Stellar-Line

Article	Name
V4-R0-T0.0006.SL0-0001	Suspension kit for Stellar-Line luminaires, length 1.2 m RAL9005 black matte
V4-R0-W0.0006.SL0-0001	Suspension kit for Stellar-Line luminaires, length 1.2 m RAL9010 white matt

## Q-40



Lamp Size: 912x40x40 mm  
 Package size of the lamp:  
 940x125x45 mm  
 PF ≥0,95



○ metal

Article	Power	Light temperature	Luminous flux*
V1-R0-70384-05000-4004030	40W	3000K	3900 lm
V1-R0-70384-05000-4004040	40W	4000K	4000 lm

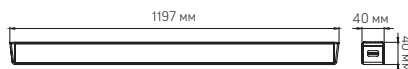
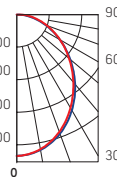

Lamp Size: 1197x40x40 mm  
 Package size of the lamp:  
 1225x125x45 mm  
 PF ≥0,95



○ metal

Article	Power	Light temperature	Luminous flux*
V1-R0-70385-05000-4005030	50W	3000K	4900 lm
V1-R0-70385-05000-4005040	50W	4000K	5000 lm

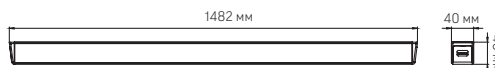
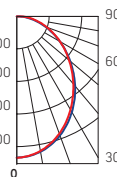

Lamp Size: 1482x40x40 mm  
 Package size of the lamp:  
 1505x125x45 mm  
 PF ≥0,95



○ metal

Article	Power	Light temperature	Luminous flux*
V1-R0-70386-05000-4006030	60W	3000K	5900 lm
V1-R0-70386-05000-4006030	60W	4000K	6000 lm

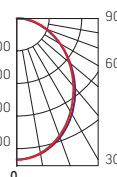

### Accessories for Q-40

Article	Name
V4-R0-70.0006.TL0-0001	Luminaire Suspension Kit (1,5x1000mm)
V4-R0-70.0006.TL0-0002	Luminaire Suspension Kit (1,5x2000mm)
V4-R0-70.0006.TL0-0003	Luminaire Suspension Kit (1,5x4000mm)

NEW MODEL



### Installation:

Surface mounting, mounting included in the package  
 Suspended installation on cables (suspension kit must be ordered separately)

### Case:

Aluminum case  
 Plastic side covers

### Diffuser:

Polycarbonate

### Specifications:

Index of color transmission Ra > 83  
 Temperature range from + 1 ° C to + 40 ° C  
 AC176-264V  
 Network frequency 50Hz +/- 10%  
 LED life 50,000 hours  
 3 year warranty  
 Luminous flux <1%  
 Light angle 100 °



NEW  
MODEL

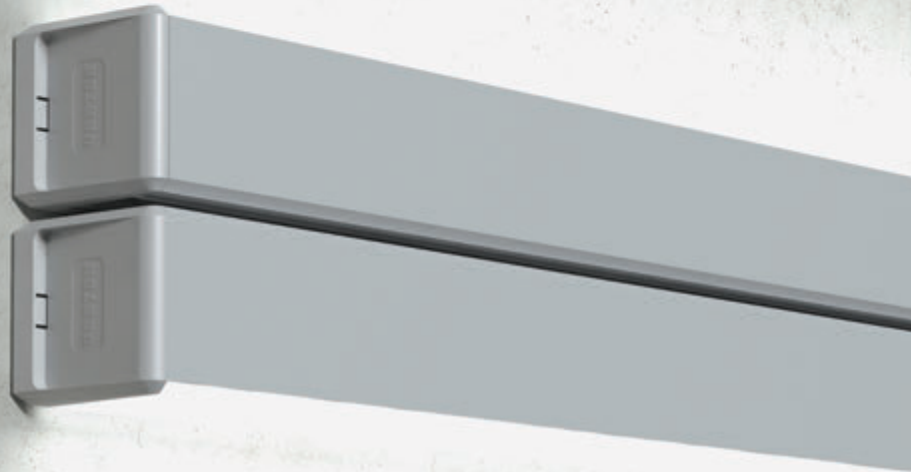

**Installation:**

Surface mounting, mounting included in the package  
Suspended installation on cables (suspension kit must be ordered separately)

**Material:**

Aluminum case  
Plastic side covers

**Diffuser:**

Polycarbonate

**Specifications:**

Index of color transmission Ra > 83  
Temperature range from + 1 ° to + 40 ° C  
AC176-264V  
Network frequency 50Hz +/- 10%  
LED life 50,000 hours  
3 year warranty  
Luminous flux Kn ≤ 1%  
Light angle 100 °



**Q-80**

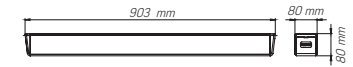

Lamp Size: 903x80x80mm  
Mounting size: 879/45mm  
Package size of the lamp:  
910x82x89mm  
PF ≥0,95



metal

Article	Power	Light temperature	Luminous flux
V1-R0-70387-05000-4004530	35W	3000K	4500lm
V1-R0-70387-05000-4004540	35W	4000K	4700lm

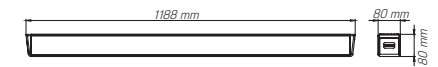
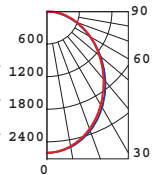

Lamp Size: 1188x80x80mm  
Mounting size: 1164/45mm  
Package size of the lamp:  
1195x82x89mm  
PF ≥0,95



metal

Article	Power	Light temperature	Luminous flux
V1-R0-70388-05000-4006030	45W	3000K	4300lm
V1-R0-70388-05000-4006040	45W	4000K	5000lm

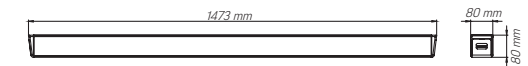
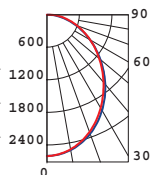

Lamp Size: 1473x80x80mm  
Mounting size: 1449/45mm  
Package size of the lamp:  
1480x82x89mm  
PF ≥0,95



metal

Article	Power	Light temperature	Luminous flux
V1-R0-70389-05000-4008030	60W	3000K	6000lm
V1-R0-70389-05000-4008040	60W	4000K	8400lm

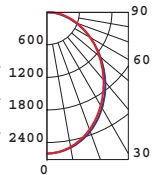

**Accessories for Q-80**

Article	Name
V4-R0-70.0006.TL0-0001	Luminaire Suspension Kit (1,5x1000mm)
V4-R0-70.0006.TL0-0002	Luminaire Suspension Kit (1,5x2000mm)
V4-R0-70.0006.TL0-0003	Luminaire Suspension Kit (1,5x4000mm)



## R-Line

1195×100×50mm

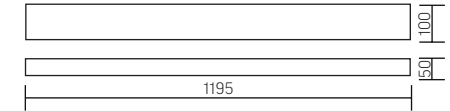

Package size of the lamp:  
1195×105×55mm

PF ≥ 0,95



○ white

Article	Power	Light temperature	Luminous flux*
---------	-------	-------------------	----------------

V1-R0-00220-20000-2003640	36W	4000K	3900lm
V1-R0-00220-20000-2003665	36W	6500K	4100lm

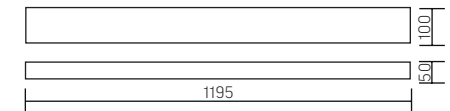

## Autonomous emergency lamp constant action

Emergency power supply unit, battery for 1 hour of autonomous operation, charge indicator, "Test" button in the set (see description on page 266)

Article	Power	Light temperature	Luminous flux*
---------	-------	-------------------	----------------

V1-R0-00220-20A00-2003640	36W	4000K	3900lm
V1-R0-00220-20A00-2003665	36W	6500K	4100lm

### Conformity:

GOST IEC 60598-2-22-2012 "Luminaires. Part 2-22. Private requirements. Luminaires for emergency lighting "SP 52. 13330. 2011" Natural and artificial lighting "(updated edition of SNiP 23.05-95)

Accessories  
(not included)

Article	Name
---------	------

V4-R0-00.0009.RL0-0001	Mounting Kit Connector
V4-R0-00.0009.RL0-0003	Side cap 105 × 56mm (2pcs.)



Diffuser (optional)

Package size of the lens (2 pcs.):  
1203×108×18mm

Article	Type	Diffuser size
---------	------	---------------

V2-R0-PR00-00.2.0016.25	Prism standard	1189×96mm
V2-R0-OP00-03.2.0016.30	Opal	1189×96mm
V2-R0-PS00-00.2.0016.20	Pin spot	1189×96mm
V2-R0-CI00-00.2.0016.20	Crushed ice	1189×96mm
V2-R0-MP00-02.2.0016.20	Microprism	1189×96mm

\* Luminous Flux Set excluding the diffuser

### Installation:

Mounting directly onto four screws to a metal cable tray

### Case:

All-metal housing made of sheet steel with white powder coating

### Specifications:

Index of color transmission Ra > 80

Temperature range from + 1 ° C to + 40 ° C

AC176-264V

Network frequency 50Hz ± 10%

LED life 50,000 hours

3 year warranty

Luminous flux Kn ≤ 1%



**R-Line**  
1195×140×50mm

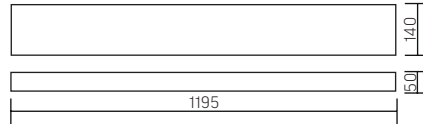

Package size of the lamp:  
1195×145×55mm  
PF ≥ 0,95



○ white

Article	Power	Light temperature	Luminous flux*
V1-R0-00098-20000-2003630	36W	3000K	3800lm
V1-R0-00098-20000-2003640	36W	4000K	3900lm
V1-R0-00098-20000-2003665	36W	6500K	4100lm
V1-R0-00098-20000-2005430	54W	3000K	5700lm
V1-R0-00098-20000-2005440	54W	4000K	5800lm
V1-R0-00098-20000-2005465	54W	6500K	6000lm

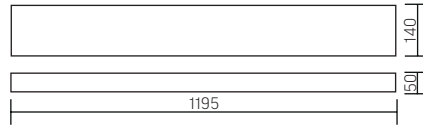

**A Autonomous emergency lamp constant action**

Emergency power supply unit, battery for 1 hour of autonomous operation, charge indicator, "Test" button in the set (see description on page 266)

**Conformity:**  
GOST IEC 60598-2-22-2012 "Luminaires. Part 2-22. Private requirements. Luminaires for emergency lighting "SP 52. 13330. 2011" Natural and artificial lighting "(updated edition of SNiP 23.05-95)

Accessories  
(not included)



Diffuser (optional)  
Package size of the lens (2 pcs.):  
1203×148×18mm

Article	Power	Light temperature	Luminous flux*
V1-R0-00098-20A00-2003630	36W	3000K	3800lm
V1-R0-00098-20A00-2003640	36W	4000K	3900lm
V1-R0-00098-20A00-2003665	36W	6500K	4100lm
V1-R0-00098-20A00-2005430	54W	3000K	5700lm
V1-R0-00098-20A00-2005440	54W	4000K	5800lm
V1-R0-00098-20A00-2005465	54W	6500K	6000lm

Article	Name
V4-R0-00.0009.RL0-0001	Mounting Kit Connector
V4-R0-00.0009.RL0-0004	Side cap 146 × 56mm (2pcs.)

Article	Type	Diffuser size
V2-R0-PR00-00.2.0091.25	Prism standard	1189×136mm
V2-R0-ME00-03.2.0091.30	Opal	1189×136mm
V2-R0-PS00-00.2.0091.20	Pin spot	1189×136mm
V2-R0-CI00-00.2.0091.20	Crushed ice	1189×136mm
V2-R0-MP00-02.2.0091.20	Microprism	1189×136mm

\* Luminous Flux Set excluding the diffuser

Hypermarket "Lenta" (St. Petersburg, Russia)



## T-Line

1174×70×90mm

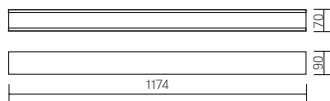

Package size of the lamp:  
1234×82×115mm  
PF ≥ 0,95



- metal
- white RAL 9003
- black RAL 9005

Article	Power	Light temperature	Luminous flux*	Colour of case
V1-R0-00033-02000-2001830	18W	3000K	1800lm	metal
V1-R0-00033-02000-2001840	18W	4000K	1900lm	metal
V1-R0-00033-02000-2001865	18W	6500K	2000lm	metal
V1-R0-00033-02000-2003630	36W	3000K	3600lm	metal
V1-R0-00033-02000-2003640	36W	4000K	3700lm	metal
V1-R0-00033-02000-2003665	36W	6500K	3800lm	metal
V1-R0-10033-02000-2003630	36W	3000K	3600 lm	white RAL 9003 Matt
V1-R0-10033-02000-2003640	36W	4000K	3700 lm	white RAL 9003 Matt
V1-R0-10033-02000-2003665	36W	6500K	3800 lm	white RAL 9003 Matt
V1-R0-90033-02000-2003630	36W	3000K	3600 lm	black RAL 9005 Matt
V1-R0-T0033-02000-2003640	36W	4000K	3700 lm	black RAL 9005 Matt
V1-R0-90033-02000-2003665	36W	6500K	3800 lm	black RAL 9005 Matt

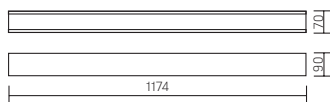
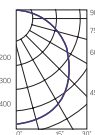

### Autonomous emergency lamp constant action

Emergency power supply unit, battery for 1 hour of autonomous operation, charge indicator, "Test" button in the set (see description on page 266)

Article	Power	Light temperature	Luminous flux*
V1-R0-00033-02A00-2001840	18W	4000K	1900lm
V1-R0-00033-02A00-2001865	18W	6500K	2000lm
V1-R0-00033-02A00-2003640	36W	4000K	3700lm
V1-R0-00033-02A00-2003665	36W	6500K	3800lm

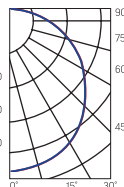

### Conformity:

GOST IEC 60598-2-22-2012 "Luminaires. Part 2-22. Private requirements. Luminaires for emergency lighting "SP 52. 13330. 2011" Natural and artificial lighting "(updated edition of SNiP 23.05-95)



Diffuser (optional)

Package size of the lens (2 pcs.):  
1205×85×18mm

Article	Type	Diffuser size
V2-R0-PR00-00.2.0013.25	Prism standard	1170×64mm
V2-R0-ME00-03.2.0013.30	Opal	1170×64mm
V2-R0-PS00-00.2.0013.20	Pin spot	1170×64mm
V2-R0-C100-00.2.0013.20	Crushed ice	1170×64mm
V2-R0-MP00-02.2.0013.20	Microprism	1170×64mm

\* Luminous Flux Set excluding the diffuser

### Installation:

Mounting on suspensions, mounting on a flat surface, as well as the possibility of assembly in a line T-shaped, L-shaped and X-shaped light turns provide a continuous uniform line without unlit areas

### Case:

Luminaire housing made of anodized aluminum profile

### Application:

Designed for lighting commercial, office and administrative premises

### Specifications:

Index of color transmission Ra > 80

Temperature range from + 1 ° C to + 40 ° C

AC176-264V

Network frequency 50Hz ± 10%

LED life 50,000 hours

3 year warranty

Luminous flux ≤ 1%



## Accessories for T-Line

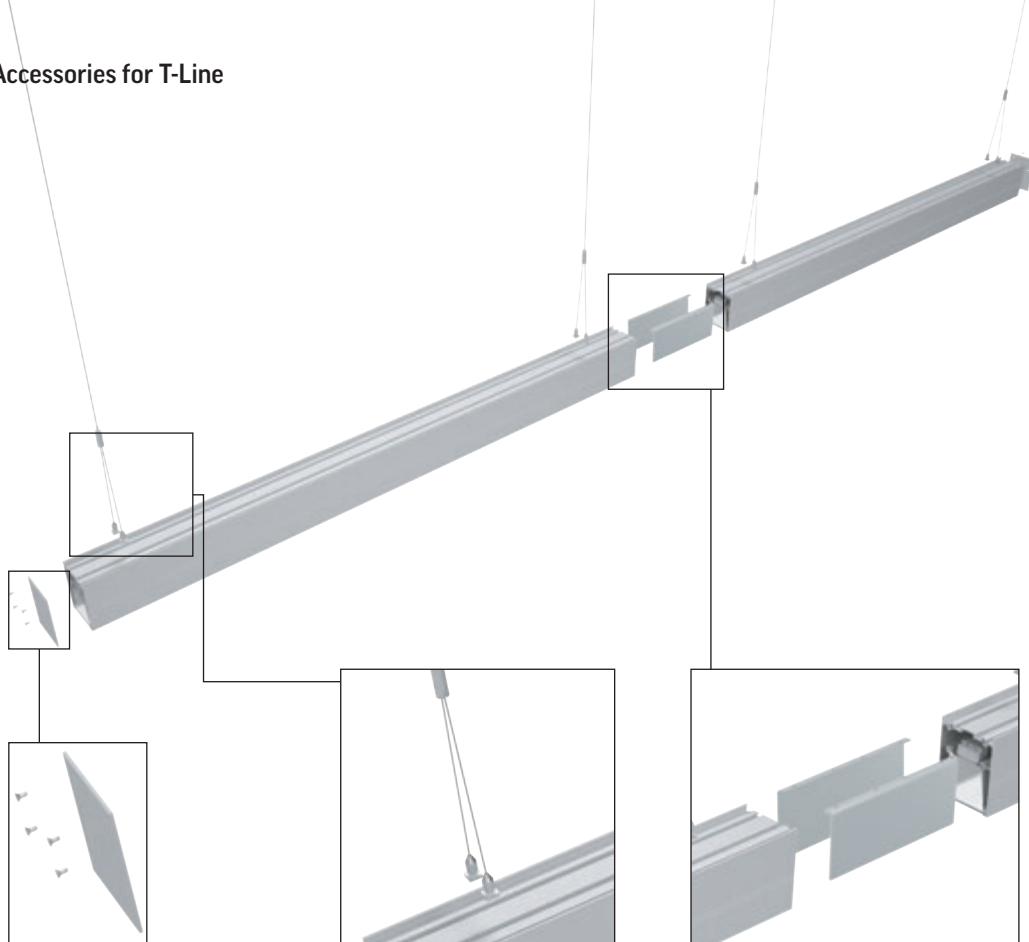

End cap deaf with a set of fasteners for lamps of the T-Line series  
Article: **V4-R0-70.0007.TL0-0001**

Kit for hanging lamps of the T-Line series (1,5x1000mm)  
Article: **V4-R0-70.0006.TL0-0001**

Kit for hanging lamps of the T-Line series (1,5x2000mm)  
Article: **V4-R0-70.0006.TL0-0002**

Kit for hanging lamps of the T-Line series (1,5x4000mm)  
Article: **V4-R0-70.0006.TL0-0003**

T-Line luminaires are single by default. To connect to the line individual accessories shall be ordered:  
Shutter for connection to the T-Line line set: 2pcs  
Article: **V4-R0-70.0006.TL0-0006**

## T-Line connectors

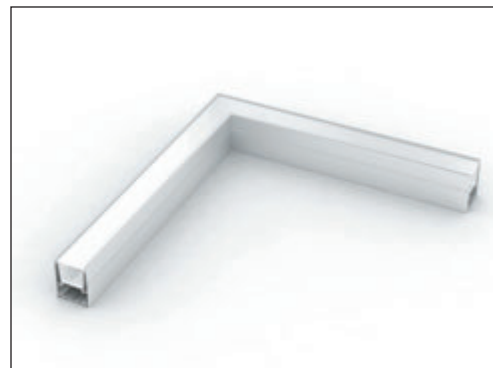

L-connection 18W, 36W

Colour of case:   
Light temperature: 3000K/4000K/6500K

V4-R0-70.0006.TL0-0001	Suspension kit (1,5x1000mm)
V4-R0-70.0006.TL0-0002	Suspension kit (1,5x2000mm)
V4-R0-70.0006.TL0-0003	Suspension kit (1,5x4000mm)
V4-R0-70.0007.TL0-0001	Deaf end cap
V4-R0-70.0006.TL0-0006	Shutter for connecting to the line T-Line: 2pcs



## Mounting options Lamp T-Line



Suspension mounting



Mounting on a flat surface



Installation through the side plane



Installation through the side plane (double T-line)





Shopping center "RIO" (Moscow, Russia)

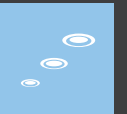

**DOWNLIGHTS**

## DL-Slim

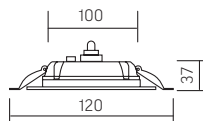

Lamp Size: 120x37 mm  
Mounting size: 100 mm  
PF ≥0,90



○ white

Article	Power	Light temperature	Luminous flux*
V1-R0-00546-10000-4401030	10W	3000K	1000 lm
V1-R0-00546-10000-4401040	10W	4000K	1100 lm
V1-R0-00546-10000-4401065	10W	6500K	1100 lm

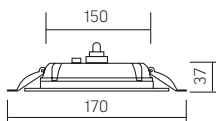
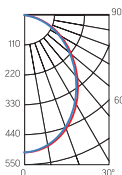

Lamp Size: 170x37 mm  
Mounting size: 150 mm  
PF ≥0,90



○ white

Article	Power	Light temperature	Luminous flux*
V1-R0-00547-10000-4402030	20W	3000K	2200 lm
V1-R0-00547-10000-4402040	20W	4000K	2400 lm
V1-R0-00547-10000-4402065	20W	6500K	2400 lm

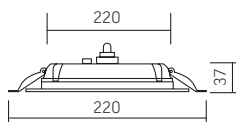
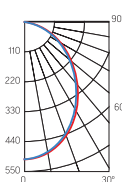

Lamp Size: 220x37 mm  
Mounting size: 200 mm  
PF ≥0,90



○ white

Article	Power	Light temperature	Luminous flux*
V1-R0-00548-10000-4403030	30W	3000K	3400 lm
V1-R0-00548-10000-4403040	30W	4000K	3600 lm
V1-R0-00548-10000-4403065	30W	6500K	3600 lm

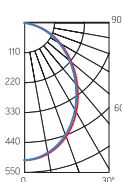

NEW  
MODEL

### Installation:

Built in

### Case:

Aluminum

### Diffuser:

Opal (PMMA)

### Specifications:

Index of color transmission Ra > 83

Temperature range from + 1 ° C to + 40 ° C

AC220-240V

Network frequency 50Hz +/- 10%

LED life 50,000 hours

3 year warranty

Luminous flux Kn <5%



NEW  
MODEL



**Installation:**

Built in

**Case:**

Aluminum

**Diffuser:**

Frosted tempered glass

**Specifications:**

Index of color transmission Ra > 84

Temperature range from -30 °C to + 40 °C

AC220-240V

Network frequency 50Hz +/- 10%

LED life 50,000 hours

3 year warranty

Suitable for use in premises of fire hazard class P-IIa



**DL-Pro IP65**

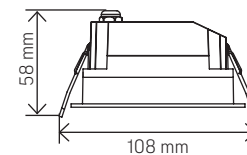

Lamp Size: 108x58 mm  
Mounting size: ø90 mm  
Package size of the lamp:  
140x150x80 mm  
PF ≥0,90



○ white RAL9010

Article	Power	Light temperature	Luminous flux	Colour of case
V1-R0-00555-10000-6501030	10W	3000K	900 lm	white
V1-R0-00555-10000-6501040	10W	4000K	1000 lm	white
V1-R0-00555-10000-6501065	10W	6500K	1000 lm	white

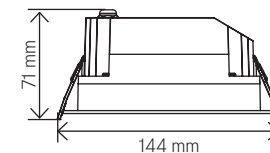
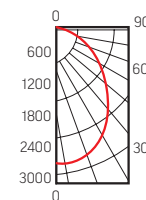

Lamp Size: 144x71 mm  
Mounting size: ø125-135 mm  
Package size of the lamp:  
165x180x90 mm  
PF ≥0,90

- white RAL9010
- grey RAL7045
- black RAL9005

Article	Power	Light temperature	Luminous flux	Colour of case
V1-R0-00556-10000-6502030	20W	3000K	1800 lm	white
V1-R0-T0556-10000-6502030	20W	3000K	1800 lm	black
V1-R0-H0556-10000-6502030	20W	3000K	1800 lm	grey
V1-R0-00556-10000-6502040	20W	4000K	2000 lm	white
V1-R0-T0556-10000-6502040	20W	4000K	2000 lm	black
V1-R0-H0556-10000-6502040	20W	4000K	2000 lm	grey
V1-R0-00556-10000-6502065	20W	6500K	2000 lm	white
V1-R0-T0556-10000-6502065	20W	6500K	2000 lm	black
V1-R0-H0556-10000-6502065	20W	6500K	2000 lm	grey

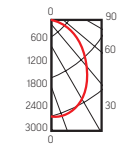

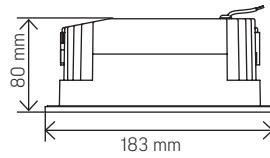

Lamp Size: 183x80 mm  
 Mounting size: 160-175 mm  
 Package size of the lamp:  
 220x220x115 mm  
 PF ≥0,90

Article	Power	Light temperature	Luminous flux	Colour of case
V1-R0-00557-10000-6503530	35W	3000K	3200 lm	white
V1-R0-T0557-10000-6503530	35W	3000K	3200 lm	black
V1-R0-H0557-10000-6503530	35W	3000K	3200 lm	grey
V1-R0-00557-10000-6503540	35W	4000K	3500 lm	white
V1-R0-T0557-10000-6503540	35W	4000K	3500 lm	black
V1-R0-H0557-10000-6503540	35W	4000K	3500 lm	grey
V1-R0-00557-10000-6503565	35W	6500K	3500 lm	white
V1-R0-T0557-10000-6503565	35W	6500K	3500 lm	black
V1-R0-H0557-10000-6503565	35W	6500K	3500 lm	grey

- white RAL9010
- grey RAL7045
- black RAL9005

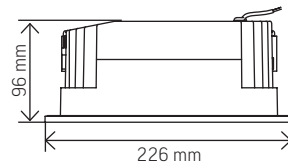
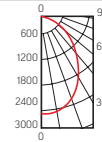

Lamp Size: 226x96 mm  
 Mounting size: ø200-215 mm  
 Package size of the lamp:  
 260x260x115 mm  
 PF ≥0,90

Article	Power	Light temperature	Luminous flux	Colour of case
V1-R0-00777-10000-6505230	52W	3000K	5000 lm	white
V1-R0-T0777-10000-6505230	52W	3000K	5000 lm	black
V1-R0-H0777-10000-6505230	52W	3000K	5000 lm	grey
V1-R0-00777-10000-6505240	52W	4000K	5300 lm	white
V1-R0-T0777-10000-6505240	52W	4000K	5300 lm	black
V1-R0-H0777-10000-6505240	52W	4000K	5300 lm	grey
V1-R0-00777-10000-6505265	52W	6500K	5300 lm	white
V1-R0-T0777-10000-6505265	52W	6500K	5300 lm	black
V1-R0-H0777-10000-6505265	52W	6500K	5300 lm	grey

- white RAL9010
- grey RAL7045
- black RAL9005

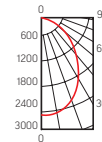

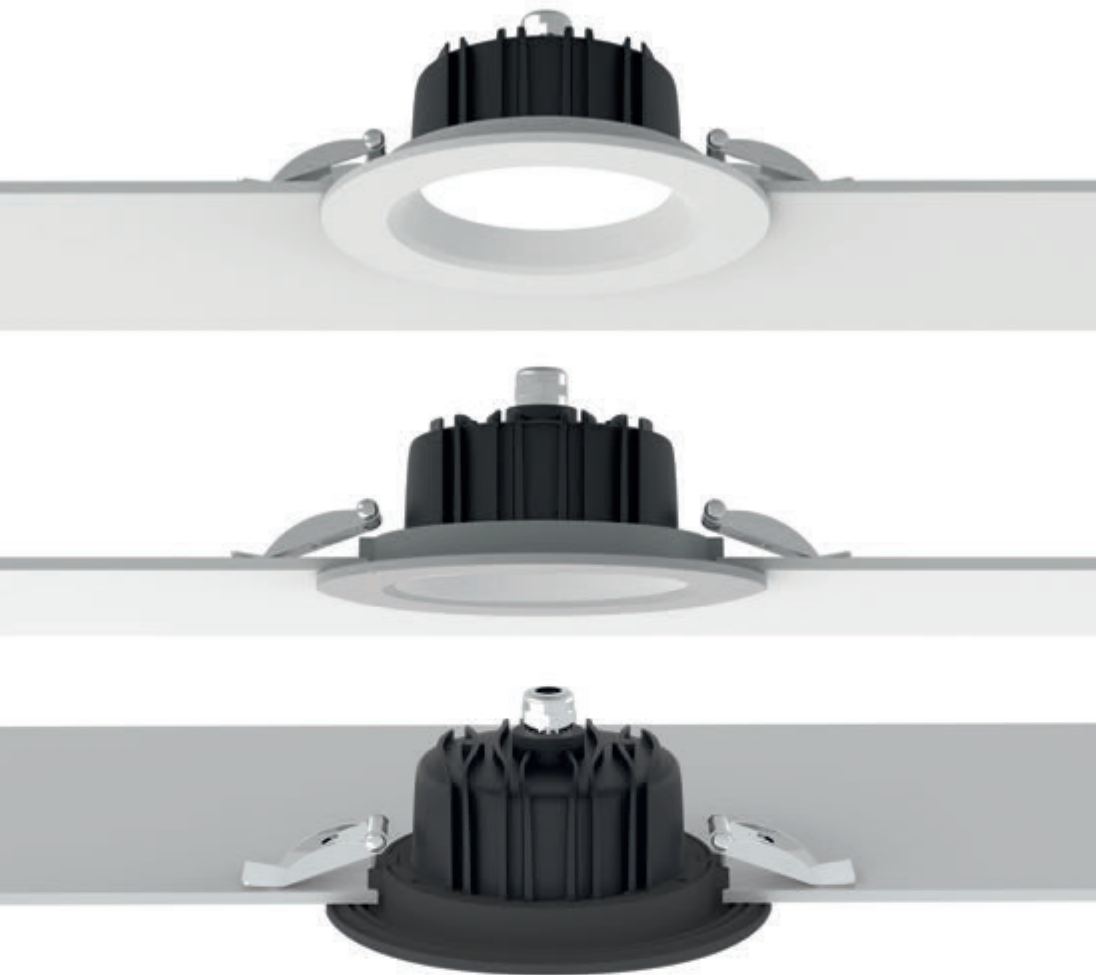

### Installation:

Clamping system  
Integrated into stretch, plaster, slatted ceiling designs

### Case:

Aluminum

### Diffuser:

Polycarbonate

### Specifications:

Index of color transmission  $R_a > 83$   
Temperature range from  $-20^{\circ}\text{C}$  to  $+40^{\circ}\text{C}$   
AC 220-240V  
Network frequency  $50\text{Hz} \pm 10\%$   
LED life 50,000 hours  
3 year warranty  
Luminous flux  $\leq 5\%$



## DL-01

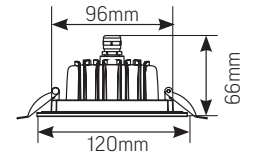

Lamp Size: 120×65mm  
Mounting size:  $\varnothing 96\text{mm}$   
Package size of the lamp: 160×130×115mm  
PF  $\geq 0,9$



- white RAL9010
- grey RAL7045
- black RAL9005

Article	Power	Light temperature	Luminous flux	Colour of case
V1-R0-01011-10000-4401130	11W	3000K	950 lm	white
V1-R0-H0011-10000-4401130	11W	3000K	950 lm	grey
V1-R0-T0011-10000-4401130	11W	3000K	950 lm	black
V1-R0-01011-10000-4401140	11W	4000K	950 lm	white
V1-R0-H0011-10000-4401140	11W	4000K	950 lm	grey
V1-R0-T0011-10000-4401140	11W	4000K	950 lm	black

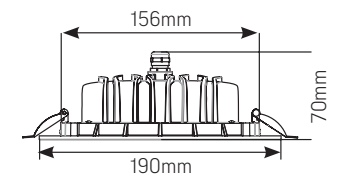
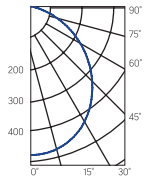

Lamp Size: 190×70mm  
Mounting size:  $\varnothing 156\text{mm}$   
Package size of the lamp: 195×195×135mm  
PF  $\geq 0,9$

- white RAL9010
- grey RAL7045
- black RAL9005

Article	Power	Light temperature	Luminous flux	Colour of case
V1-R0-00083-10000-4401630	16W	3000K	1500 lm	white
V1-R0-H0083-10000-4401630	16W	3000K	1500 lm	grey
V1-R0-T0083-10000-4401630	16W	3000K	1500 lm	black
V1-R0-00083-10000-4401640	16W	4000K	1500 lm	white
V1-R0-H0083-10000-4401640	16W	4000K	1500 lm	grey
V1-R0-T0083-10000-4401640	16W	4000K	1500 lm	black

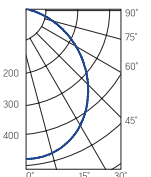

## DL-01

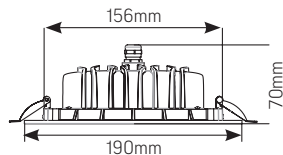

Lamp Size:  
190×70mm  
Mounting size: ø156mm  
Package size of the lamp:  
195×195×135mm  
PF ≥ 0,9

- white RAL9010
- grey RAL7045
- black RAL9005

Article	Power	Light temperature	Luminous flux	Colour of case
V1-R0-00083-10000-4402530	25W	3000K	2200 lm	white
V1-R0-H0083-10000-4402530	25W	3000K	2200 lm	grey
V1-R0-T0083-10000-4402530	25W	3000K	2200 lm	black
V1-R0-00083-10000-4402540	25W	4000K	2200 lm	white
V1-R0-H0083-10000-4402540	25W	4000K	2200 lm	grey
V1-R0-T0083-10000-4402540	25W	4000K	2200 lm	black

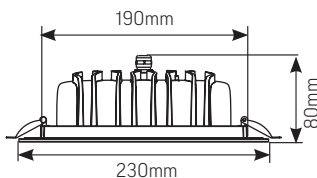
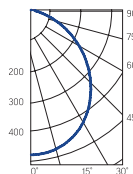

Lamp Size:  
230×80mm  
Mounting size: ø190mm  
Package size of the lamp:  
245×245×127mm  
PF ≥ 0,9

- white RAL9010
- grey RAL7045
- black RAL9005

Article	Power	Light temperature	Luminous flux	Colour of case
V1-R0-00084-10000-4404030	40W	3000K	3400 lm	white
V1-R0-H0084-10000-4404030	40W	3000K	3400 lm	grey
V1-R0-T0084-10000-4404030	40W	3000K	3400 lm	black
V1-R0-00084-10000-4404040	40W	4000K	3400 lm	white
V1-R0-H0084-10000-4404040	40W	4000K	3400 lm	grey
V1-R0-T0084-10000-4404040	40W	4000K	3400 lm	black

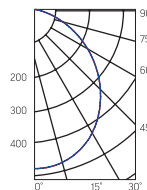

### Autonomous emergency lamp permanent action

Emergency power supply unit, battery for 1 hour of autonomous operation, charge indicator, "Test" button in the set (see description on page 266)

#### Conformity:

GOST IEC 60598-2-22-2012 "Luminaires. Part 2-22."  
Private requirements. Luminaires for emergency lighting "SP 52. 13330. 2011" Natural and artificial lighting "(updated edition of SNiP 23.05-95)"

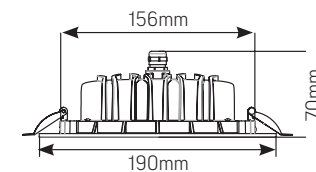

Article	Power	Light temperature	Luminous flux
V1-R0-01011-10A00-4401140	11W	4000K	800lm
V1-R0-00083-10A00-4401640	16W	4000K	1300lm
V1-R0-00A83-10A00-4402540	25W	4000K	2000lm
V1-R0-00084-10A00-4404040	40W	4000K	3200lm

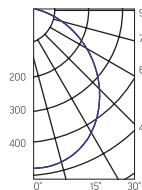

### DALI

Lamp Size:  
190×70mm  
Mounting size: ø156mm  
Driver size (included):  
90×40×28mm/152×68×40mm  
PF ≥ 0,9

- white

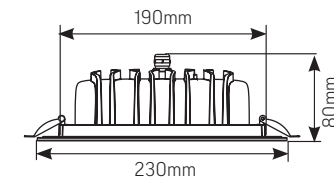

Article	Power	Light temperature	Luminous flux
V1-R0-00083-10D01-4401630	16W	3000K	1300lm
V1-R0-00083-10D01-4401640	16W	4000K	1300lm
V1-R0-00083-10D01-4402530	25W	3000K	2000lm
V1-R0-00083-10D01-4402540	25W	4000K	2000lm

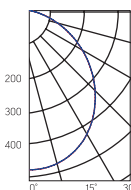

### DALI

Lamp Size:  
230×84mm  
Mounting size: ø190mm  
Package size of the lamp:  
245×245×127mm  
PF ≥ 0,9

- white

Article	Power	Light temperature	Luminous flux
V1-R0-00084-10D01-4404030	40W	3000K	3200lm
V1-R0-00084-10D01-4404040	40W	4000K	3200lm

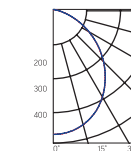

## DL-02 Tube

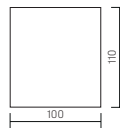

Lamp Size: 100×110mm  
 Package size of the lamp:  
 105×105×145mm  
 PF ≥ 0,9



○ white ● grey ● black

Article	Power	Light temperature	Luminous flux	Colour of case
V1-R0-00113-20000-2001230	12W	3000K	1100 lm	white
V1-R0-H0113-20000-2001230	12W	3000K	1100 lm	grey
V1-R0-T0113-20000-2001230	12W	3000K	1100 lm	black
V1-R0-00113-20000-2001240	12W	4000K	1300 lm	white
V1-R0-H0113-20000-2001240	12W	4000K	1300 lm	grey
V1-R0-T0113-20000-2001240	12W	4000K	1300 lm	black

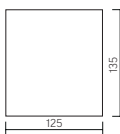
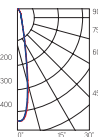

Lamp Size: 125×135mm  
 Package size of the lamp:  
 130×130×170mm  
 PF ≥ 0,9

○ white ● grey ● black

Article	Power	Light temperature	Luminous flux	Colour of case
V1-R0-00113-20000-2001830	18W	3000K	1400 lm	white
V1-R0-H0113-20000-2001830	18W	3000K	1400 lm	grey
V1-R0-T0113-20000-2001830	18W	3000K	1400 lm	black
V1-R0-00113-20000-2001840	18W	4000K	1600 lm	white
V1-R0-H0113-20000-2001840	18W	4000K	1600 lm	grey
V1-R0-T0113-20000-2001840	18W	4000K	1600 lm	black

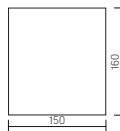
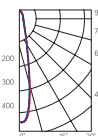

Lamp Size: 150×160mm  
 Package size of the lamp:  
 155×155×195mm  
 PF ≥ 0,9

○ white ● grey ● black

Article	Power	Light temperature	Luminous flux	Colour of case
V1-R0-00113-20000-2001230	12W	3000K	1100 lm	white
V1-R0-H0113-20000-2001230	12W	3000K	1100 lm	grey
V1-R0-T0113-20000-2001230	12W	3000K	1100 lm	black
V1-R0-00113-20000-2001240	12W	4000K	1300 lm	white
V1-R0-H0113-20000-2001240	12W	4000K	1300 lm	grey
V1-R0-T0113-20000-2001240	12W	4000K	1300 lm	black

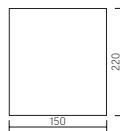
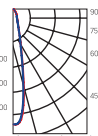

**NEW MODEL**  
 Lamp Size: 220×150mm  
 Package size of the lamp:  
 175×175×250mm  
 PF ≥ 0,9

○ white ● grey ● black

Article	Power	Light temperature	Luminous flux	Colour of case
V1-R0-00391-20000-2005530	55W	3000K	5200 lm	white
V1-R0-H0391-20000-2005530	55W	3000K	5200 lm	grey
V1-R0-T0391-20000-2005530	55W	3000K	5200 lm	black
V1-R0-00391-20000-2005540	55W	4000K	5400 lm	white
V1-R0-H0391-20000-2005540	55W	4000K	5400 lm	grey
V1-R0-T0391-20000-2005540	55W	4000K	5400 lm	black

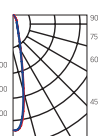

### Installation:

Surface mounting system  
 Designed for all types of ceilings

### Case:

Aluminum, powder coated  
 Large radiator area for efficient heat removal  
 Tempered glass diffuser

### Specifications:

Index of color transmission Ra > 83  
 Temperature range from + 1 ° C to + 40 ° C  
 AC220-240V  
 Network frequency 50Hz ± 10%  
 LED life 50,000 hours  
 3 year warranty  
 Luminous flux Kn <5%  
 Light angle 35 °





**Installation:**

Implemented on a horizontal or vertical surface  
Mounting kit included

**Case:**

Aluminum, powder coated  
Large radiator area for efficient heat removal  
Tempered glass diffuser

**Specifications:**

Index of color transmission Ra > 83  
Temperature range from + 1 ° C to + 40 ° C  
AC220-240V  
Network frequency 50Hz +/- 10%  
LED life 50,000 hours  
3 year warranty  
Luminous flux Kn ≤ 5%  
Light angle 35



**DL-02 Cube**

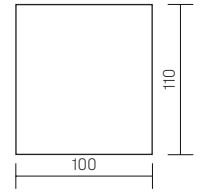

Lamp Size:  
100×100×110mm  
Package size of the lamp:  
105×105×145mm  
PF ≥ 0,9



○ white ● grey ● black

Article	Power	Light temperature	Luminous flux	Colour of case
V1-R0-00360-20000-2001230	12W	3000K	1100 lm	white
V1-R0-H0360-20000-2001230	12W	3000K	1100 lm	grey
V1-R0-T0360-20000-2001230	12W	3000K	1100 lm	black
V1-R0-00360-20000-2001240	12W	4000K	1300 lm	white
V1-R0-H0360-20000-2001240	12W	4000K	1300 lm	grey
V1-R0-T0360-20000-2001240	12W	4000K	1300 lm	black

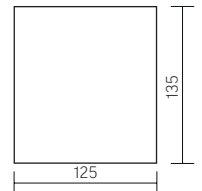
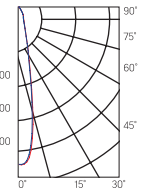

Lamp Size:  
125×125×135mm  
Package size of the lamp:  
130×130×170mm  
PF ≥ 0,9

○ white ● grey ● black

Article	Power	Light temperature	Luminous flux	Colour of case
V1-R0-00360-20000-2002030	20W	3000K	1700 lm	white
V1-R0-H0360-20000-2002030	20W	3000K	1700 lm	grey
V1-R0-T0360-20000-2002030	20W	3000K	1700 lm	black
V1-R0-00360-20000-2002040	20W	4000K	1900 lm	white
V1-R0-H0360-20000-2002040	20W	4000K	1900 lm	grey
V1-R0-T0360-20000-2002040	20W	4000K	1900 lm	black

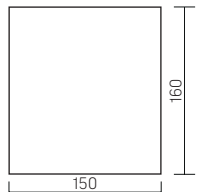
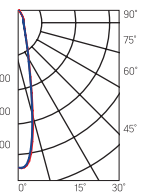

Lamp Size:  
150×150×160mm  
Package size of the lamp:  
155×155×195mm  
PF ≥ 0,9

○ white ● grey ● black

Article	Power	Light temperature	Luminous flux	Colour of case
V1-R0-00360-20000-2003630	36W	3000K	3000 lm	white
V1-R0-H0360-20000-2003630	36W	3000K	3000 lm	grey
V1-R0-T0360-20000-2003630	36W	3000K	3000 lm	black
V1-R0-00360-20000-2003640	36W	4000K	3200 lm	white
V1-R0-H0360-20000-2003640	36W	4000K	3200 lm	grey
V1-R0-T0360-20000-2003640	36W	4000K	3200 lm	black

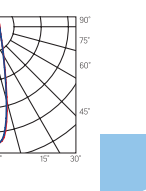



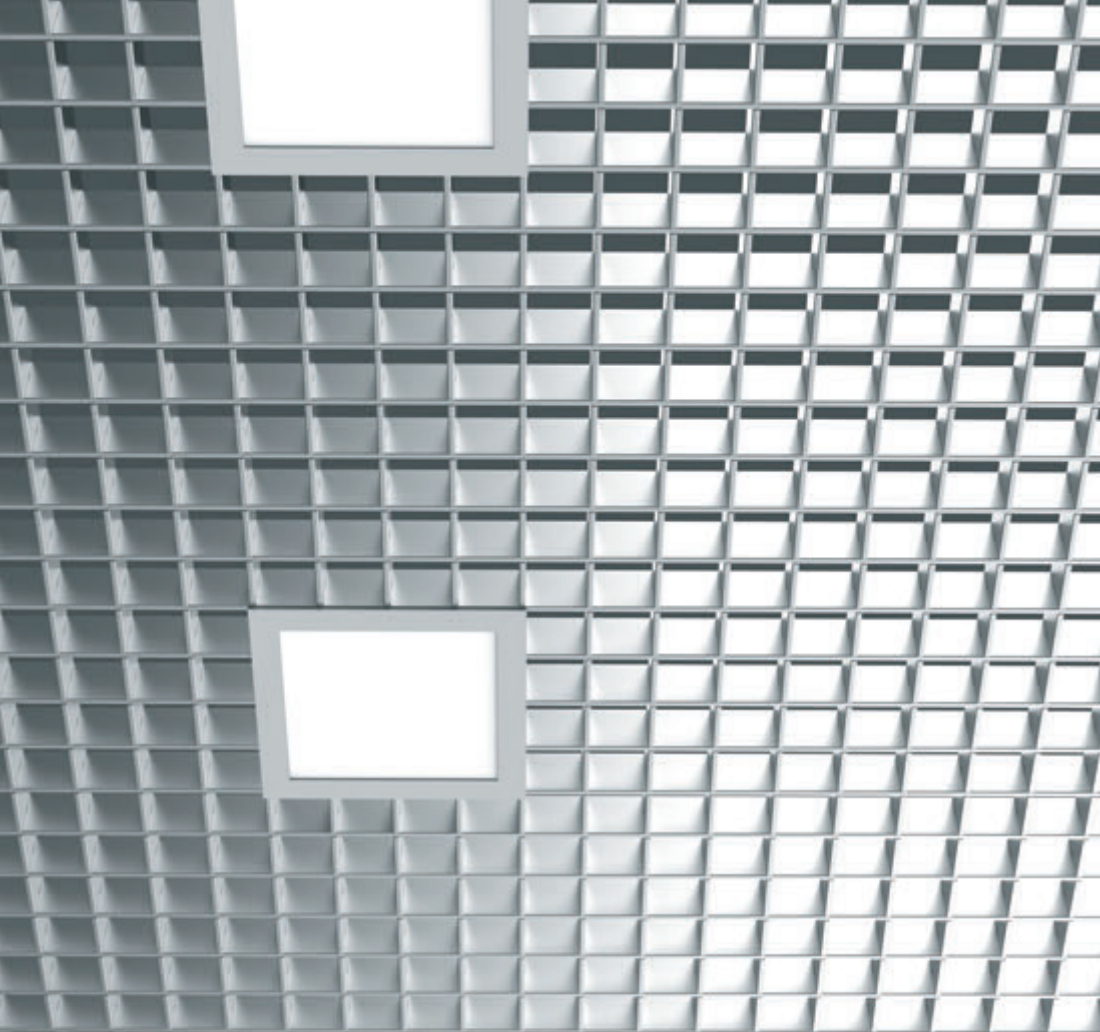

## DL-03

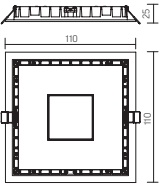

Lamp Size: 110x110x25mm  
 Mounting size: 90x90mm  
 Package size of the lamp:  
 140x125x48mm  
 PF ≥0,95



○ white ● grey ● black



Article	Power	Light temperature	Luminous flux	Colour of case
V1-R0-00354-10000-4401230	12W	3000K	950 lm	white
V1-R0-00354-10000-4401240	12W	4000K	1000 lm	white
V1-R0-H0354-10000-4401230	12W	3000K	950 lm	grey
V1-R0-H0354-10000-4401240	12W	4000K	1000 lm	grey
V1-R0-T0354-10000-4401230	12W	3000K	950 lm	black
V1-R0-T0354-10000-4401240	12W	4000K	1000 lm	black

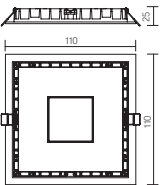
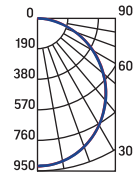

### **A** Autonomous emergency lamp constant action

Emergency power supply unit, battery for 1 hour of autonomous operation, charge indicator, «Test» button in the set (see description on page 266)

**Conformity:**  
 GOST IEC 60598-2-22-2012 –Luminaires. Part 2-22. Private requirements. Luminaires for emergency lighting «SP 52. 13330. 2011– Natural and artificial lighting »(updated edition of SNiP 23.05-95))



Article	Power	Light temperature	Luminous flux	Colour of case
V1-R0-00354-10D01-4401230	12W	3000K	950 lm	white
V1-R0-00354-10D01-4401240	12W	4000K	1000 lm	white
V1-R0-H0354-10D01-4401230	12W	3000K	950 lm	grey
V1-R0-H0354-10D01-4401240	12W	4000K	1000 lm	grey
V1-R0-T0354-10D01-4401230	12W	3000K	950 lm	black
V1-R0-T0354-10D01-4401240	12W	4000K	1000 lm	black

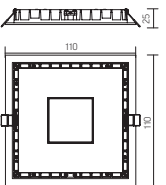
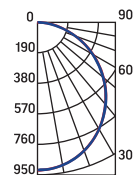

### **DALI**

Lamp Size:110x110x25mm  
 Package size of the lamp:  
 90x90mm  
 Package size of the lamp:  
 140x125x48mm  
 PF ≥0,95

○ white ● grey ● black

Article	Power	Light temperature	Luminous flux	Colour of case
V1-R0-00354-10A00-4401230	12W	3000K	950 lm	white
V1-R0-00354-10A00-4401240	12W	4000K	1000 lm	white
V1-R0-H0354-10A00-4401230	12W	3000K	950 lm	grey
V1-R0-H0354-10A00-4401240	12W	4000K	1000 lm	grey
V1-R0-T0354-10A00-4401230	12W	3000K	950 lm	black
V1-R0-T0354-10A00-4401240	12W	4000K	1000 lm	black

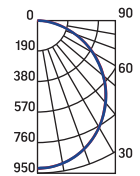

### Installation:

Clamping system for mounting in the gypsum board, slatted ceilings and ceilings Grilyato

### Body Material:

Aluminum

### Diffuser material:

Polycarbonate

### Specifications:

Index of color transmission Ra >84

Temperature range from + 1 ° to + 40 ° C

AC220-240V

Network frequency 50Hz +/- 10%

LED life 50,000 hours

3 year warranty

Luminous flux Kn <5%

Angle of dispersion of Luminous flux 110°



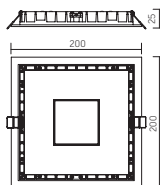

Lamp Size: 200x200x25mm  
 Package size of the lamp:  
 185x185mm  
 Package size of the lamp:  
 258x233x45mm  
 PF ≥0,95



○ white ● grey ● black



Article	Power	Light temperature	Luminous flux	Colour of case
V1-R0-00342-10000-4402530	25W	3000K	2400 lm	white
V1-R0-00342-10000-4402540	25W	4000K	2500 lm	white
V1-R0-H0342-10000-4402530	25W	3000K	2400 lm	grey
V1-R0-H0342-10000-4402540	25W	4000K	2500 lm	grey
V1-R0-T0342-10000-4402530	25W	3000K	2400 lm	black
V1-R0-T0342-10000-4402540	25W	4000K	2500 lm	black

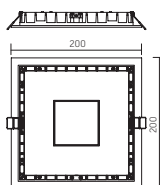
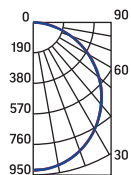

### Autonomous emergency lamp constant action

Emergency power supply unit, battery for 1 hour of autonomous operation, charge indicator, «Test» button in the set (see description on page 266)

#### Conformity:

GOST IEC 60598-2-22-2012 –Luminaires. Part 2-22. Private requirements. Luminaires for emergency lighting «SP 52. 13330. 2011– Natural and artificial lighting »(updated edition of SNiP 23.05-95))



Article	Power	Light temperature	Luminous flux	Colour of case
V1-R0-00342-10D01-4402530	25W	3000K	2400 lm	white
V1-R0-00342-10D01-4402540	25W	4000K	2500 lm	white
V1-R0-H0342-10D01-4402530	25W	3000K	2400 lm	grey
V1-R0-H0342-10D01-4402540	25W	4000K	2500 lm	grey
V1-R0-T0342-10D01-4402530	25W	3000K	2400 lm	black
V1-R0-T0342-10D01-4402540	25W	4000K	2500 lm	black

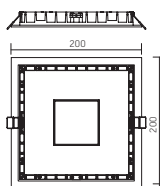
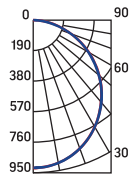

### DALI

Lamp Size: 110x110x25mm  
 Package size of the lamp:  
 90x90mm  
 Package size of the lamp:  
 140x125x48mm  
 PF ≥0,95

○ white ● grey ● black

Article	Power	Light temperature	Luminous flux	Colour of case
V1-R0-00342-10A00-4402530	25W	3000K	2400 lm	white
V1-R0-00342-10A00-4402540	25W	4000K	2500 lm	white
V1-R0-H0342-10A00-4402530	25W	3000K	2400 lm	grey
V1-R0-H0342-10A00-4402540	25W	4000K	2500 lm	grey
V1-R0-T0342-10A00-4402530	25W	3000K	2400 lm	black
V1-R0-T0342-10A00-4402540	25W	4000K	2500 lm	black

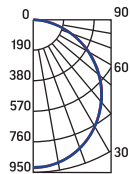

## DL-LENS Comfort

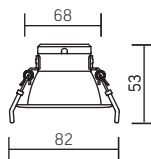

Lamp Size: 82x53mm  
 Mounting size: 68 mm  
 Package size of the lamp:  
 100x100x90 mm  
 PF ≥0,90



○ white

Article	Power	Light temperature	Luminous flux
V1-R0-Y0508-10XXX-2001030	11W	3000K	900 lm
V1-R0-Y0508-10XXX-2001040	11W	4000K	1000 lm

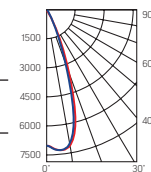

XXX = L01 -angle 15°  
 XXX = R10 -angle 24°  
 XXX = L18 -angle 35°

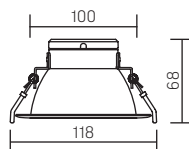

Lamp Size: 118x68 mm  
 Mounting size: 100 mm  
 Package size of the lamp:  
 120x120x110 mm  
 PF ≥0,90



○ white

Article	Power	Light temperature	Luminous flux
V1-R0-Y0509-10XXX-2001430	14W	3000K	1400 lm
V1-R0-Y0509-10XXX-2001440	14W	4000K	1500 lm

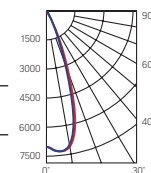

XXX = L01 -angle 15°  
 XXX = R10 -angle 24°  
 XXX = L18 -angle 35°

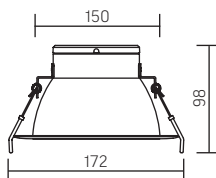

Lamp Size: 172x98 mm  
 Mounting size: 150 mm  
 Package size of the lamp:  
 180x180x130 mm  
 PF ≥0,90



○ white

Article	Power	Light temperature	Luminous flux
V1-R0-Y0510-10XXX-2002830	28W	3000K	2600 lm
V1-R0-Y0510-10XXX-2002840	28W	4000K	2800 lm

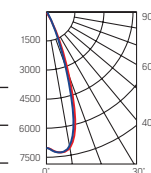

XXX = L01 -angle 15°  
 XXX = R10 -angle 24°  
 XXX = L18 -angle 35°

### Installation:

The lamp is built into the plasterboard ceilings

### Body Material:

Aluminum

### Diffuser:

Replaceable PMMA lens at an angle of 35 degrees included.

### Specifications:

Index of color transmission Ra > 82

Temperature range from + 1 ° C to + 40 ° C

AC220-240V

Network frequency 50Hz +/- 10%

LED life 50,000 hours

3 year warranty

Luminous flux <5%

UGR <19



## DL-LENS Comfort

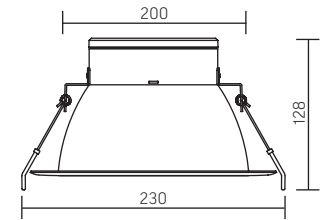

Lamp Size: 230x128 mm  
 Mounting size: 200 mm  
 Package size of the lamp:  
 240x240x150 mm  
 PF ≥0,90



○ white

Article	Power	Light temperature	Luminous flux
V1-R0-Y0511-10XXX-2003830	36W	3000K	3500 lm
V1-R0-Y0511-10XXX-2003840	36W	4000K	3700 lm

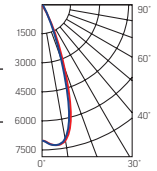

XXX = L01 -angle 15°  
 XXX = R10 -angle 24°  
 XXX = L18 -angle 35°



NEW  
MODEL



**Installation:**

Built-in (clamping mounting system)

**Case:**

Aluminum (matte silver reflector included)

**Diffuser:**

Polycarbonate

**Specifications:**

Index of color transmission Ra > 84

Temperature range from + 1 ° C to + 40 ° C

AC220-240V

Network frequency 50Hz +/- 10%

LED life 50,000 hours

3 year warranty

Luminous flux Kn <5%

Angle of light 60 °

UGR <19



**DL-Spark Comfort**

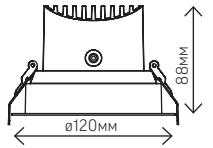

Lamp Size: 120x88 mm  
Mounting hole 100 mm  
Package size of the lamp:  
153x153x130 mm  
PF ≥0,95



○ white

Article	Power	Light temperature	Luminous flux
V1-R0-00433-10L07-4401530	15W	3000K	1100 lm
V1-R0-00433-10L07-4401540	15W	4000K	1300 lm

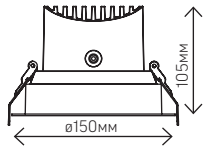
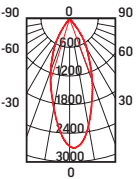

Lamp Size: 150x105mm  
Mounting hole : 130 mm  
Package size of the lamp:  
160x160x110mm  
PF ≥0,95



○ white

Article	Power	Light temperature	Luminous flux
V1-R0-00434-10L07-4402530	25W	3000K	1900lm
V1-R0-00434-10L07-4402540	25W	4000K	2100lm

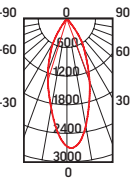

**DALI** PF ≥0,95





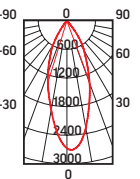

○ white

Article	Power	Light temperature	Luminous flux
V1-R0-00433-10D01-4401530	15W	3000K	1100 lm
V1-R0-00433-10D01-4401540	15W	4000K	1300 lm
V1-R0-00434-10D01-4402530	25W	3000K	1900 lm
V1-R0-00434-10D01-4402540	25W	4000K	2100 lm



## Replaceable reflectors

	Article	Name
	V1-R0-F0433-10L07-0000000	Reflector for DL-SPARK 15W Matt gold
	V1-R0-D0433-10L07-0000000	Reflector for DL-SPARK 15W Matt black
	V1-R0-E0433-10L07-0000000	Reflector for DL-SPARK 15W chrome
	V1-R0-F0434-10L07-0000000	Reflector for DL-SPARK 25W Matt gold
	V1-R0-D0434-10L07-0000000	Reflector for DL-SPARK 25W Matt black
	V1-R0-E0434-10L07-0000000	Reflector for DL-SPARK 25W chrome

## DL-Spark mounting scheme



## DL-Stellar Comfort

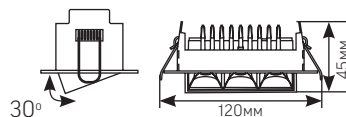

Lamp Size: 120x62x45mm  
 Mounting size: 108x48mm  
 Package size of the lamp:  
 155x95x70mm  
 PF ≥0,95



○ white

Article	Power	Light temperature	Luminous flux
V1-R0-00408-10L25-2000830	8W	3000K	500lm
V1-R0-00408-10L25-2000840	8W	4000K	550lm

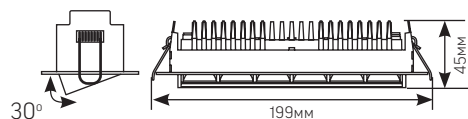
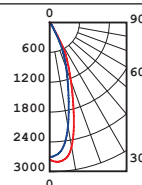

Lamp Size: 199x62x45mm  
 Mounting size: 183x48mm  
 Package size of the lamp:  
 235x100x70mm  
 PF ≥0,95



○ white

Article	Power	Light temperature	Luminous flux
V1-R0-00409-10L25-2001530	15W	3000K	950lm
V1-R0-00409-10L25-2001540	15W	4000K	1000lm

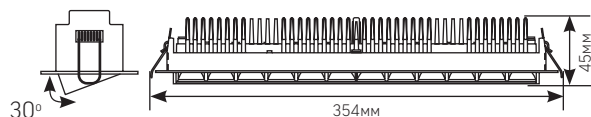
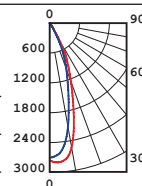

Lamp Size: 354x62x45mm  
 Mounting size: 342x48mm  
 Package size of the lamp:  
 395x100x70mm  
 PF ≥0,95



○ white

Article	Power	Light temperature	Luminous flux
V1-R0-00410-10L25-2003030	30W	3000K	1900lm
V1-R0-00410-10L25-2003040	30W	4000K	2000lm

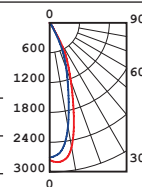

### Installation:

Clamping mounting system for mounting in the gypsum board

### Body Material:

Aluminum

### Benefits:

Shadowless lighting of the room

Rotary body (radius 30°)

UGR <13

### Specifications:

Index of color transmission Ra > 84

Temperature range from +1° to +40° C

AC220-240V

Network frequency 50Hz +/- 10%

LED life 50,000 hours

3 year warranty

Luminous flux ≤ 5%

Light diffusion angle 34°





## DL-Tetris

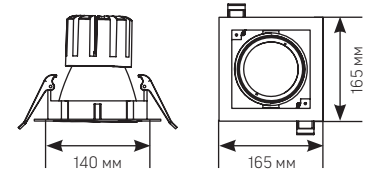

Lamp Size: 165x165x140mm  
 Mounting size: 140x140mm  
 Package size of the lamp:  
 205x205x185mm  
 PF ≥0,95



○ white

Article	Power	Light temperature	Luminous flux
V1-R0-00424-10000-2002530	25W	3000K	2250lm
V1-R0-00424-10000-2002540	25W	4000K	2500lm
V1-R0-00424-10000-2004030	40W	3000K	3600lm
V1-R0-00424-10000-2004040	40W	4000K	4000lm

## Accessories для DL-Tetris

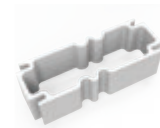

Article	Name
V4-R0-00.0033.DL0-0001	Connecting bracket for lamp DL-TETRIS
V4-R0-00.0033.DL0-0002	Connection bracket for square connection

## Example lamp assembly using the connector and the connecting bracket

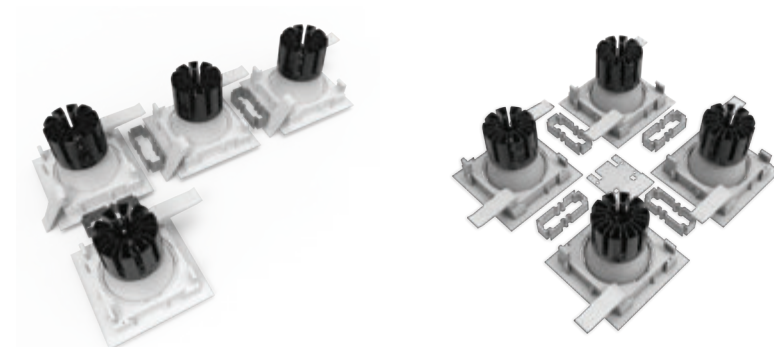

### Installation:

Built in

### Body Material:

Aluminum

### Diffuser material:

Strained glass

### Specifications:

Index of color transmission Ra > 90

Temperature range from + 1 ° to + 40 ° C

AC220-240V

Network frequency 50Hz +/- 10%

LED life 50,000 hours

3 year warranty

Luminous flux Kn ≤ 5%

Light diffusion angle of 35 ° (angles of 15 ° and 45 ° on request)





DL/R

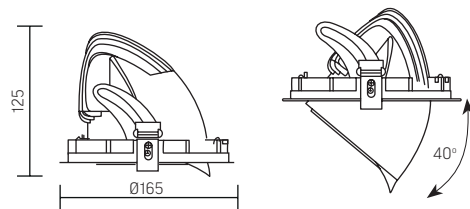

Lamp Size: 165x125mm  
 Mounting size: Ø155mm  
 Package size of the lamp:  
 195x195x145mm  
 PF ≥ 0,95



○ white

**DALI**

Article	Power	Light temperature	Luminous flux
V1-R0-00411-10R03-2003030	30W	3000K	2600lm
V1-R0-00411-10R03-2003040	30W	4000K	2700lm

Article	Power	Light temperature	Luminous flux
V1-R0-00411-10R03-2003030	30W	3000K	2600lm
V1-R0-00411-10R03-2003040	30W	4000K	2700lm

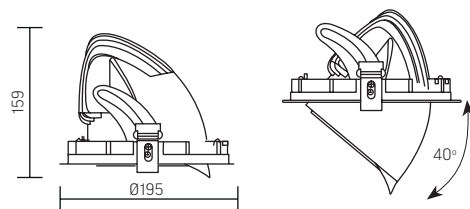
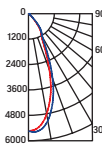

Lamp Size: 195x159mm  
 Mounting size: Ø185mm  
 Package size of the lamp:  
 230x230x170mm  
 PF ≥ 0,95

○ white

**DALI**

Article	Power	Light temperature	Luminous flux
V1-R0-00412-10R03-2005030	50W	3000K	4400lm
V1-R0-00412-10R03-2005040	50W	4000K	4500lm

Article	Power	Light temperature	Luminous flux
V1-R0-00412-10R03-2005030	50W	3000K	4400lm
V1-R0-00412-10R03-2005040	50W	4000K	4500lm

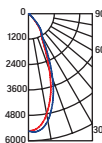

**NEW MODEL**



**Installation:**

Clamping system for mounting in the gypsum board, slatted ceilings and ceilings Grilyato

**Body Material:**

Aluminum

**Diffuser material:**

Glass

**Specifications:**

Index of color transmission Ra > 84

Temperature range from + 1 ° to + 40 ° C

AC220-240V

Network frequency 50Hz +/- 10%

LED life 50,000 hours

3 year warranty

Luminous flux ≤ 5%

Angle of dispersion of a light stream 40 °



"Gubernsky Apteki", Krasnoyarsk



**LIGHTING OF CLEAN  
AND MEDICAL PREMISES**

# LUMINAIRES SERIES FOR CLEAN PREMISES AND HEALTH CARE OBJECTS

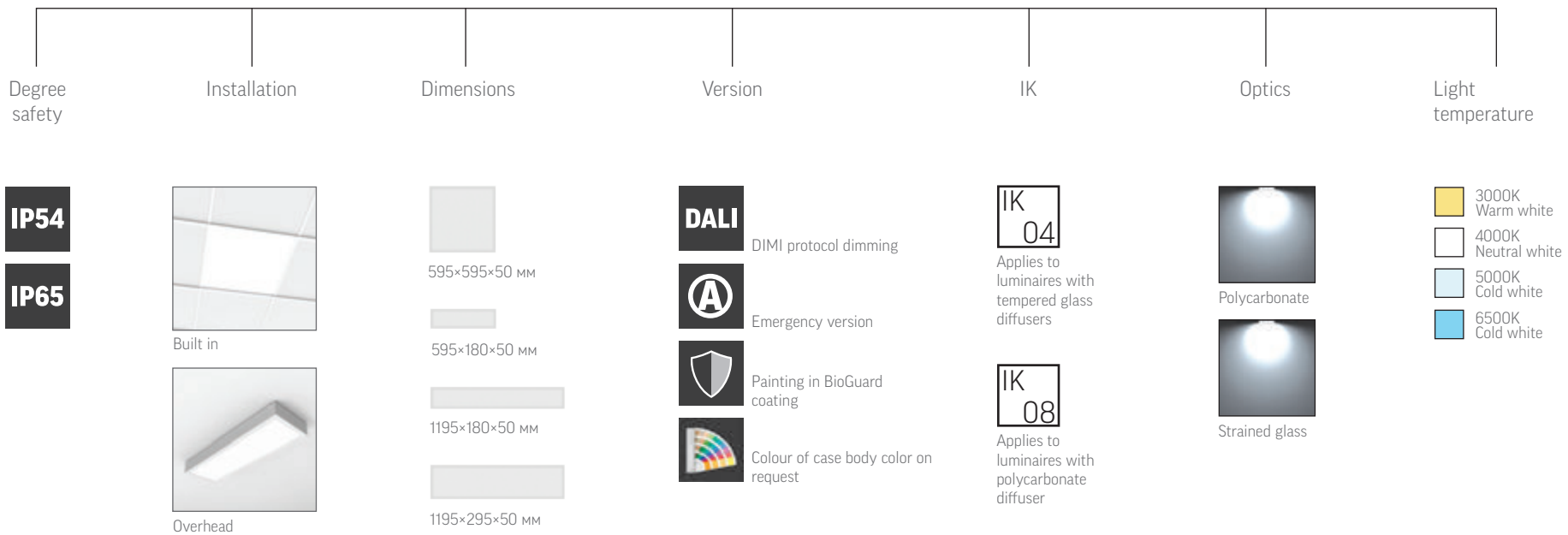

## C PANEL IP65

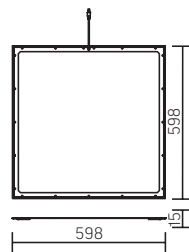

Lamp Size: 598x598x15mm  
 Package size of the lamp:  
 660x620x35mm  
 PF ≥0,95



○ white

Article	Power	Light temperature	Luminous flux
EE936511140	36W	3000K	2900lm
EE936511240	36W	4000K	3000lm
CV936511336	36W	6500K	3700lm

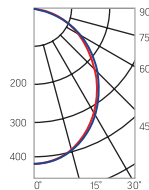

### Accessories C PANEL IP65

Photo	Article	Name
	V4-A0-70.0018.PNL-0012	Surface mounting frame 600x600x50mm

NEW  
MODEL

#### Installation:

Consignment / Embedded

#### Body Material:

Aluminum

#### Diffuser material:

Polycarbonate

#### Specifications:

Index of color transmission Ra > 83

Temperature range from -30 ° to + 40 ° C

AC220-240V

Network frequency 50Hz +/- 10%

LED life 50,000 hours

3 year warranty

Luminous flux Kn ≤ 5%

The scattering angle of the light flux 115 °

# C170/NGL

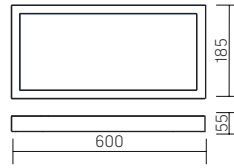
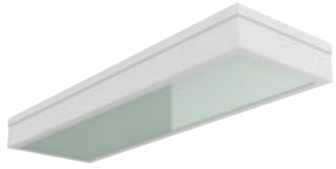

Lamp Size: 595x180x55 mm  
 Package size of the lamp:  
 600x185x60 mm  
 PF ≥0,90

Article	Power	Light temperature	Luminous flux
V1-C0-00180-XXG06-5401840	18W	4000K	1800 lm
V1-C0-00180-XXG06-5401850	18W	5000K	2000 lm
V1-C0-00180-XXG06-5401865	18W	6500K	2000 lm

XX = 10 – recessed luminary  
 XX = 20 – overhead luminary

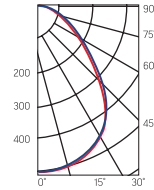

**Installation:**

Embedded installation in suspended ceiling systems with T-profile  
 Surface mounted installation on a flat surface (mounts included)

**Case:**

All-metal housing made of sheet steel

**Diffuser:**

Luminaires are equipped with tempered frosted glass diffuser

**Application:**

Lamps are suitable for installation in fire-hazardous premises of class P-IIa

**Specifications:**

Index of color transmission Ra > 80  
 Temperature range from -20 °C to + 40 °C  
 AC176-264V  
 Network frequency 50Hz +/- 10%  
 LED life 50,000 hours  
 3 year warranty  
 Luminous flux Kn <1%





## C350/GL

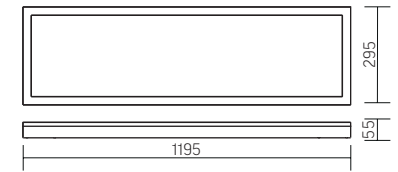

Lamp Size: 1195x295x55 mm  
 Package size of the lamp:  
 1228x308x66 mm  
 PF ≥0,95



Article	Power	Light temperature	Luminous flux
V1-C0-00350-10G06-5403640	36W	4000K	3800 lm
V1-C0-00350-10G06-5403650	36W	5000K	3800 lm
V1-C0-00350-10G06-5403665	36W	6500K	3800 lm
V1-C0-00350-10G06-5405440	54W	4000K	5400 lm
V1-C0-00350-10G06-5405450	54W	5000K	5400 lm
V1-C0-00350-10G06-5405465	54W	6500K	5400 lm

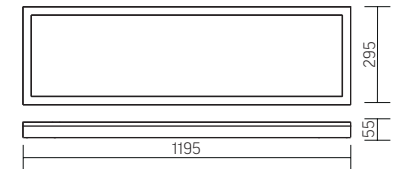
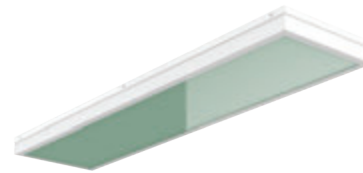
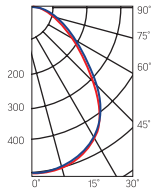

### Autonomous emergency lamp permanent action

Emergency power supply unit, battery for 1 hour of autonomous operation, charge indicator, -Test button, button in the set (see description on page 266)

**Conformity:**  
 GOST IEC 60598-2-22-2012 –Luminaires. Part 2-22. Private requirements. Luminaires for emergency lighting SP 52. 13330. 2011– Natural and artificial lighting "(updated edition of SNIP 23.05-95)

Article	Power	Light temperature	Luminous flux
V1-C0-00350-10G07-5403640	36W	4000K	3800 lm
V1-C0-00350-10G07-5403650	36W	5000K	3800 lm
V1-C0-00350-10G07-5403665	36W	6500K	3800 lm
V1-C0-00350-10G07-5405440	54W	4000K	5400 lm
V1-C0-00350-10G07-5405450	54W	5000K	5400 lm
V1-C0-00350-10G07-5405465	54W	6500K	5400 lm

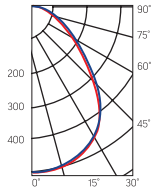

### Installation:

Surface mounted installation on a flat surface (mounts included)

### Case:

All-metal housing made of sheet steel

### Diffuser:

Luminaires are equipped with tempered frosted glass diffuser

### Application:

Lamps are suitable for installation in fire-hazardous premises of class P-IIa

### Specifications:

Index of color transmission Ra > 80

Temperature range from -20 °C to + 40 °C

AC176-264V

Network frequency 50Hz +/- 10%

LED life 50,000 hours

3 year warranty

Luminous flux Kn <1%



**C070, C070/N**  
595×595×55mm

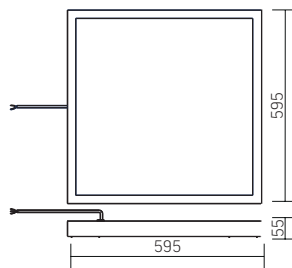

Package size of the lamp:  
627×614×62mm  
PF ≥ 0,95



NEW MODEL

Article	Power	Light temperature	Luminous flux
V1-C0-00080-XX000-5403630	36W	3000K	3400 lm
V1-C0-00080-XX000-5403640	36W	4000K	3600 lm
V1-C0-00080-XX000-5403650	36W	5000K	3600 lm
V1-C0-00080-XX000-5403665	36W	6500K	3700 lm
V1-C0-00080-XX000-5405430	54W	3000K	5100 lm
V1-C0-00080-XX000-5405440	54W	4000K	5300 lm
V1-C0-00080-XX000-5405450	54W	5000K	5300 lm
V1-C0-00080-XX000-5405465	54W	6500K	5400 lm

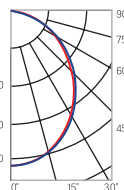

NEW MODEL

XX = 10 – built in luminary  
XX = 20 – overhead luminary

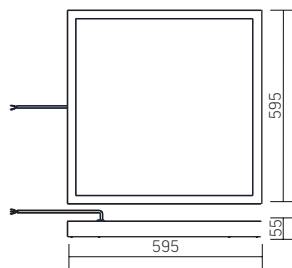

**A Autonomous emergency lamp permanent action**

Emergency power supply unit, battery for 1 hour of autonomous operation, charge indicator, –Test button in the set (see description on page 266)

**Conformity:**  
GOST IEC 60598-2-22:2012  
–Luminary. Part 2-22.  
Private requirements. Luminary for emergency lighting SP.52.13330.2011–  
Natural and artificial lighting "(updated edition of SNiP 23.05-95)

NEW MODEL

Article	Power	Light temperature	Luminous flux
V1-C0-00080-XXA00-5403630	36W	3000K	3400 lm
V1-C0-00080-XXA00-5403640	36W	4000K	3600 lm
V1-C0-00080-XXA00-5403650	36W	5000K	3600 lm
V1-C0-00080-XXA00-5403665	36W	6500K	3700 lm
V1-C0-00080-XXA00-5405430	54W	3000K	5100 lm
V1-C0-00080-XXA00-5405440	54W	4000K	5300 lm
V1-C0-00080-XXA00-5405450	54W	5000K	5300 lm
V1-C0-00080-XXA00-5405465	54W	6500K	5400 lm

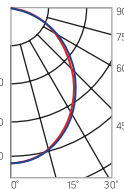

NEW MODEL

XX = 10 – built in luminary  
XX = 20 – overhead luminary

**Installation:**

Built into Armstrong suspended ceilings

**Case:**

All-metal housing made of sheet steel with white powder coating  
To ensure the degree of protection IP54 around the perimeter of the body is fixed silicone seal

**Application of luminaire with degree of protection IP54:**

Medical facilities, restaurants, food processing facilities, canteens, laboratories, toilets, rooms with high humidity

**Diffuser:**

Complete with opal polycarbonate diffuser

**Specifications:**

Index of color transmission Ra > 80  
Temperature range from -20 °C to + 40 °C  
AC176-264V  
Network frequency 50Hz ± 10%  
LED life 50,000 hours  
3 year warranty  
Luminous flux Kn ≤ 1%



**C070/GL, C070/NGL**  
595×595×55mm

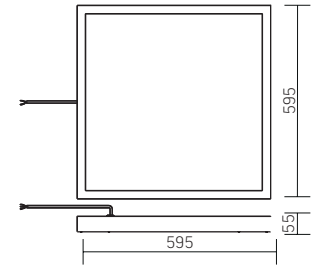
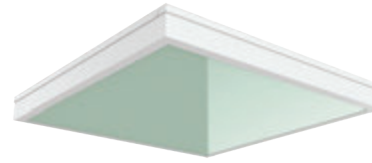

Package size of the lamp:  
627×614×62mm  
PF ≥ 0,95



○ white

Article	Power	Light temperature	Luminous flux
V1-C0-00080-XXG06-5403630	36W	3000K	3500 lm
V1-C0-00080-XXG06-5403640	36W	4000K	3700 lm
<b>NOVAYA MODEL'</b> V1-C0-00080-XXG06-5403650	36W	5000K	3700 lm
V1-C0-00080-XXG06-5403665	36W	6500K	3800 lm
V1-C0-00080-XXG06-5405430	54W	3000K	5400 lm
V1-C0-00080-XXG06-5405440	54W	4000K	5600 lm
<b>NOVAYA MODEL'</b> V1-C0-00080-XXG06-5405450	54W	5000K	5600 lm
V1-C0-00080-XXG06-5405465	54W	6500K	5700 lm

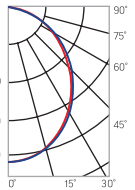

**XX** = 10 – built in luminary  
**XX** = 20 – overhead luminary

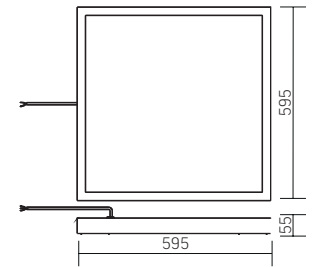
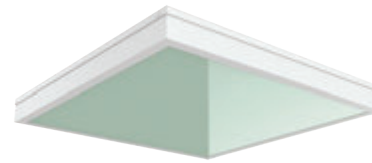

**Installation:**

Built into Armstrong suspended ceilings

**Case:**

All-metal housing made of sheet steel with white powder coating  
To ensure the degree of protection IP54 around the perimeter of the body is fixed silicone seal

**Application:**

It is used in fire-hazardous premises of class P-IIa

**Diffuser:**

Complete with tempered glass diffuser

**Specifications:**

Index of color transmission Ra > 80

Temperature range from -20 °C to + 40 °C

AC176-264V

Network frequency 50Hz ± 10%

LED life 50,000 hours

3 year warranty

Luminous flux Kn ≤ 1%



**A Autonomous emergency lamp permanent action**

Emergency power supply unit, battery for 1 hour of autonomous operation, charge indicator, –Test button in the set (see description on page 266)

Article	Power	Light temperature	Luminous flux
V1-C0-00080-XXG07-5403630	36W	3000K	3500 lm
V1-C0-00080-XXG07-5403640	36W	4000K	3700 lm
<b>NOVAYA MODEL'</b> V1-C0-00080-XXG07-5403650	36W	5000K	3700 lm
V1-C0-00080-XXG07-5403665	36W	6500K	3800 lm
V1-C0-00080-XXG07-5405430	54W	3000K	5400 lm
V1-C0-00080-XXG07-5405440	54W	4000K	5600 lm
<b>NOVAYA MODEL'</b> V1-C0-00080-XXG07-5405450	54W	5000K	5600 lm
V1-C0-00080-XXG07-5405465	54W	6500K	5700 lm

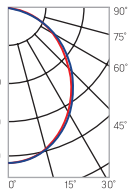

**Conformity:**

GOST IEC 60598-2-22-2012.

Part 2-22. Private Requirements/.

Luminaries for emergency lighting» SP 52.13330. 2011 «Natural and artificial lighting» (updated edition SNIP 23.05-95)

It is recommended to secure the lamp with independent suspensions to the supporting structures.

**XX** = 10 – built in luminary  
**XX** = 20 – overhead luminary





**C270, C270/N**  
1195×180×55mm

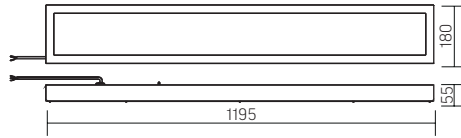

Package size of the lamp:  
1232×199×62mm  
PF ≥ 0,95



Article	Power	Light temperature	Luminous flux
V1-CO-00280-XX000-5403630	36W	3000K	3100 lm
V1-CO-00280-XX000-5403640	36W	4000K	3200 lm
V1-CO-00280-XX000-5403650	36W	5000K	3200 lm
V1-CO-00280-XX000-5403665	36W	6500K	3200 lm
V1-CO-00280-XX000-5405430	54W	3000K	4000 lm
V1-CO-00280-XX000-5405440	54W	4000K	4200 lm
V1-CO-00280-XX000-5405450	54W	5000K	4200 lm
V1-CO-00280-XX000-5405465	54W	6500K	4200 lm

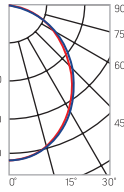

NEW MODEL

NEW MODEL

XX = 10 – built in luminary  
XX = 20 – overhead luminary

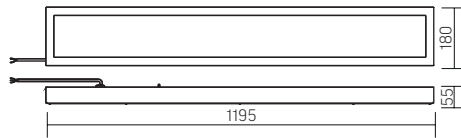

**A** Autonomous emergency lamp permanent action

Emergency power supply unit, battery for 1 hour of autonomous operation, charge indicator, –Test button in the set (see description on page 266)

**Conformity:**  
GOST IEC 60598-2-22-2012 – Luminaries, Part 2-22. Private requirements. Luminaries for emergency lighting SP 52. 13330. 2011– Natural and artificial lighting (updated edition of SNiP 23.05-95)

Article	Power	Light temperature	Luminous flux
V1-CO-00280-XXA00-5403630	36W	3000K	3100 lm
V1-CO-00280-XXA00-5403640	36W	4000K	3200 lm
V1-CO-00280-XXA00-5403650	36W	5000K	3200 lm
V1-CO-00280-XXA00-5403665	36W	6500K	3200 lm
V1-CO-00280-XXA00-5405430	54W	3000K	4000 lm
V1-CO-00280-XXA00-5405440	54W	4000K	4200 lm
V1-CO-00280-XXA00-5405450	54W	5000K	4200 lm
V1-CO-00280-XXA00-5405465	54W	6500K	4200 lm

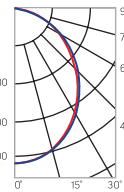

NEW MODEL

NEW MODEL

XX = 10 – built in luminary  
XX = 20 – overhead luminary

**Installation:**

Built into Armstrong suspended ceilings

**Case:**

All-metal housing made of sheet steel with white powder coating  
To ensure the degree of protection IP54 around the perimeter of the body is fixed silicone seal

**Application of luminaire with degree of protection IP54:**

Medical facilities, restaurants, food processing facilities, canteens, laboratories, toilets, rooms with high humidity

**Diffuser:**

Complete with opal polycarbonate diffuser

**Specifications:**

Index of color transmission Ra > 80  
Temperature range from -20 °C to + 40 °C  
AC176-264V  
Network frequency 50Hz ± 10%  
LED life 50,000 hours  
3 year warranty  
Luminous flux Kn ≤ 1%





## C170, C170/N

595×180×55mm

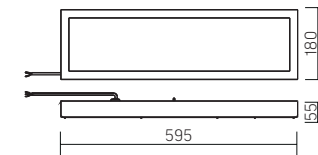

Package size of the lamp:  
1232×199×62mm  
PF ≥ 0,95



Article	Power	Light temperature	Luminous flux
V1-C0-00180-XX000-5401830	18W	3000K	1600 lm
V1-C0-00180-XX000-5401840	18W	4000K	1800 lm
<b>NEW MODEL</b> V1-C0-00180-XX000-5401850	18W	5000K	1800 lm
V1-C0-00180-XX000-5401865	18W	6500K	1800 lm

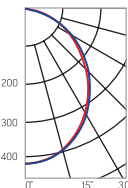

XX = 10 – built in luminary  
XX = 20 – overhead luminary

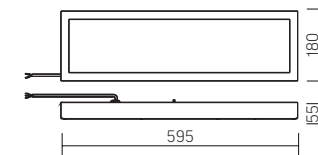

### Installation:

Built into Armstrong suspended ceilings

### Case:

All-metal housing made of sheet steel with white powder coating  
To ensure the degree of protection IP54 around the perimeter of the body is fixed silicone seal

### Application of luminaire with degree of protection IP54:

Medical facilities, restaurants, food processing facilities, canteens, laboratories, toilets, rooms with high humidity

### Diffuser:

Complete with opal polycarbonate diffuser

### Specifications:

Index of color transmission Ra > 80

Temperature range from -20 °C to + 40 °C

AC176-264V

Network frequency 50Hz ± 10%

LED life 50,000 hours

3 year warranty

Luminous flux Kn ≤ 1%



### **A** Autonomous emergency lamp permanent action

Emergency power supply unit, battery for 1 hour of autonomous operation, charge indicator, –Test button in the set (see description on page 266)

Article	Power	Light temperature	Luminous flux
V1-C0-00180-XXA00-5401830	18W	3000K	1600 lm
V1-C0-00180-XXA00-5401840	18W	4000K	1800 lm
<b>NEW MODEL</b> V1-C0-00180-XXA00-5401850	18W	5000K	1800 lm
V1-C0-00180-XXA00-5401865	18W	6500K	1800 lm

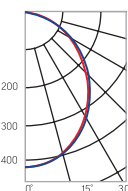

XX = 10 – built in luminary  
XX = 20 – overhead luminary

### Conformity:

GOST IEC 60598-2-22-2012

–Luminary. Part 2-22.

Private requirements. Luminary for emergency lighting SP 52. 13330. 2011– Natural and artificial lighting "(updated edition of SNiP 23.05-95)



**C350, C350/N**  
1195×295×55mm

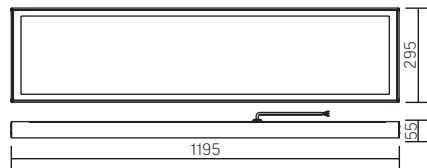

Package size of the lamp:  
1228x308x66mm  
PF ≥ 0,95



○ white

Article	Power	Light temperature	Luminous flux
V1-CO-00350-XX000-5403630	36W	3000K	3300 lm
V1-CO-00350-XX000-5403640	36W	4000K	3600 lm
V1-CO-00350-XX000-5403650	36W	5000K	3600 lm
V1-CO-00350-XX000-5403665	36W	6500K	3600 lm
V1-CO-00350-XX000-5405430	54W	3000K	5000 lm
V1-CO-00350-XX000-5405440	54W	4000K	5300 lm
V1-CO-00350-XX000-5405450	54W	5000K	5300 lm
V1-CO-00350-XX000-5405465	54W	6500K	5300 lm

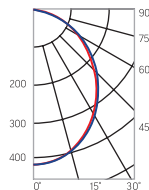

NEW MODEL

NEW MODEL

XX = 10 – built in luminary  
XX = 20 – overhead luminary

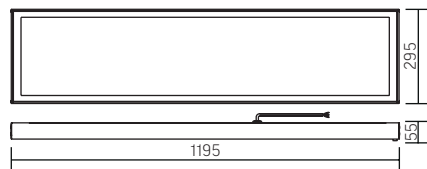

**A** Autonomous emergency lamp permanent action

Emergency power supply unit, battery for 1 hour of autonomous operation, charge indicator, – Test button in the set (see description on page 266)

**Conformity:**

GOST IEC 60598-2-22-2012 – Luminary. Part 2-22. Private requirements. Luminary for emergency lighting SP 52. 13330. 2011– Natural and artificial lighting” (updated edition of SNiP 23.05-95)

Article	Power	Light temperature	Luminous flux
V1-CO-00350-XXA00-5403630	36W	3000K	3300 lm
V1-CO-00350-XXA00-5403640	36W	4000K	3600 lm
V1-CO-00350-XXA00-5403650	36W	5000K	3600 lm
V1-CO-00350-XXA00-5403665	36W	6500K	3600 lm
V1-CO-00350-XXA00-5405430	54W	3000K	5000 lm
V1-CO-00350-XXA00-5405440	54W	4000K	5300 lm
V1-CO-00350-XXA00-5405450	54W	5000K	5300 lm
V1-CO-00350-XXA00-5405465	54W	6500K	5300 lm

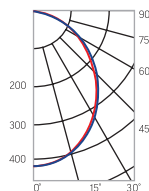

NEW MODEL

NEW MODEL

XX = 10 – built in luminary  
XX = 20 – overhead luminary

NEW MODEL



**Installation:**

Built into Armstrong suspended ceilings

**Case:**

All-metal housing made of sheet steel with white powder coating. To ensure the degree of protection IP54 around the perimeter of the body is fixed silicone seal

**Application of luminaire with degree of protection IP54:**

Medical facilities, restaurants, food processing facilities, canteens, laboratories, toilets, rooms with high humidity

**Diffuser:**

Complete with opal polycarbonate diffuser

**Specifications:**

- Index of color transmission Ra > 80
- Temperature range from -20 °C to + 40 °C
- AC176-264V
- Network frequency 50Hz ± 10%
- LED life 50,000 hours
- 3 year warranty
- Luminous flux Kn ≤ 1%





**LIGHTING SCHOOLS  
AND EDUCATIONAL INSTITUTIONS**

**E070**  
595×595×50mm

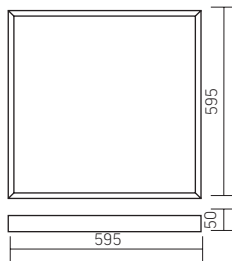

Package size of the lamp:  
627×614×62mm  
PF ≥ 0,95



○ white

Article	Power	Light temperature	Luminous flux
---------	-------	-------------------	---------------

V1-E0-00070-01000-XX03639	36W	3950K	5000lm
---------------------------	-----	-------	--------

XX = 20 – lamp with degree of protection IP20  
XX = 40 – lamp with degree of protection IP40

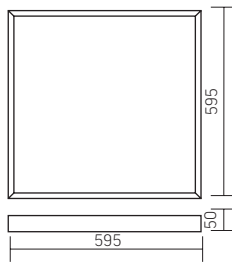
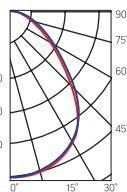

**Autonomous emergency lamp permanent action**

Emergency power supply unit, battery for 1 hour of autonomous operation, charge indicator, "Test" button in the set (see description on page 266)

**Conformity:**

GOST IEC 60598-2-22-2012 "Fixtures. Part 2-22. Private requirements. Fixtures for emergency lighting "SP 52. 13330. 2011" Natural and artificial lighting "(updated edition of SNiP 23.05-95)



Diffuser (optional)  
Pack size of diffuser (2 pcs.):  
610×610×16mm

Article	Power	Light temperature	Luminous flux
---------	-------	-------------------	---------------

V1-E0-00070-01A00-2003639	36W	3950K	5000lm
---------------------------	-----	-------	--------

XX = 20 – lamp with degree of protection IP20  
XX = 40 – lamp with degree of protection IP40

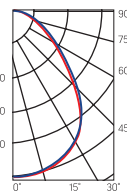

Article	Type	Diffuser size
V2-A0-PR00-00.2.0007.25	Prism standart	588×588mm
V2-A0-OP00-03.2.0007.15	Opal	588×588mm
V2-A0-PS00-00.2.0007.20	Pin Spot	588×588mm
V2-A0-CI00-00.2.0007.20	Crushed ice	588×588mm
V2-A0-MP00-02.2.0007.20	Microprism	588×588mm

\*Luminous Flux Set excluding the diffuser

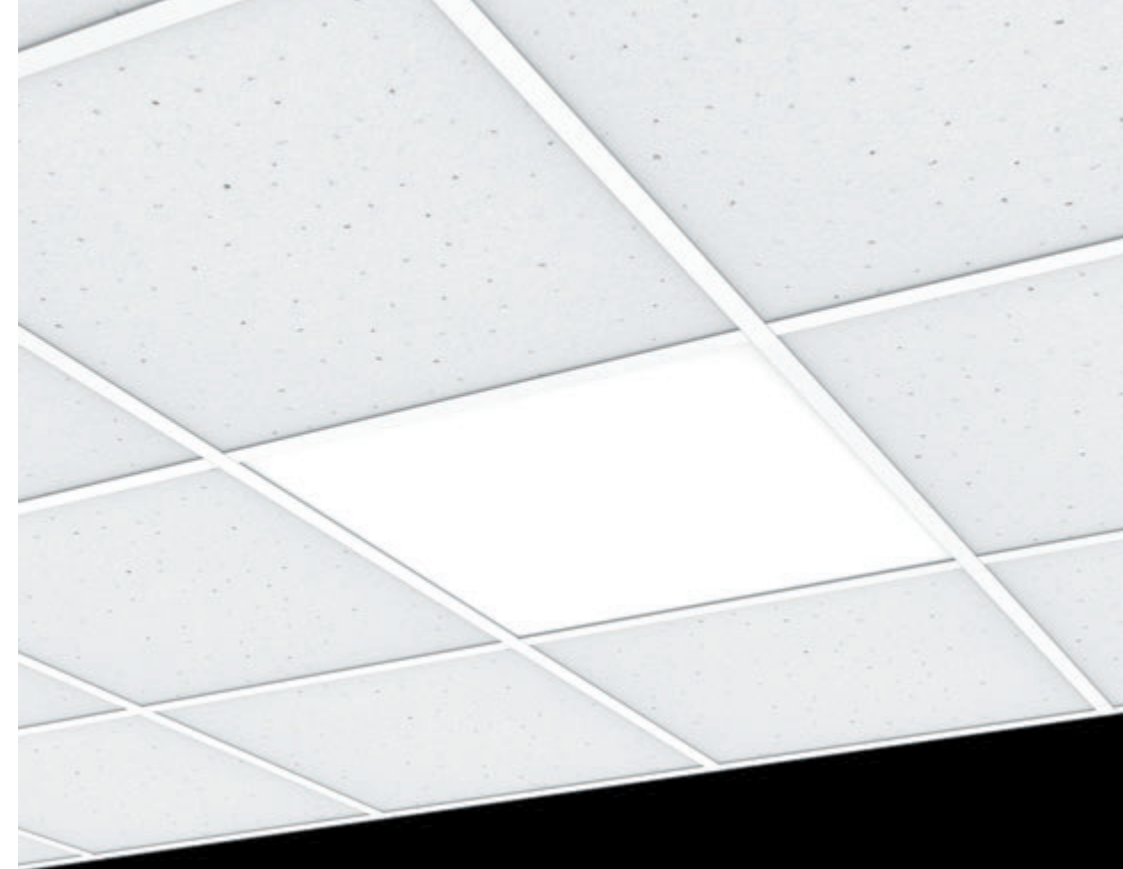

**Installation:**

Embedded in Armstrong suspended ceilings or mounted on a flat surface.

**Case:**

All-metal housing made of sheet steel with white powder coating

**Application:**

Preschool, school, secondary special, higher and other educational institutions

**Specifications:**

Diode power 0,2W  
Index of color transmission Ra > 80  
Temperature range from + 1 ° C to + 40 ° C  
AC176-264V  
Network frequency 50Hz ± 10%  
LED life 50,000 hours  
3 year warranty  
Luminous flux Kn ≤ 1%





**E270**  
1195×180×50mm

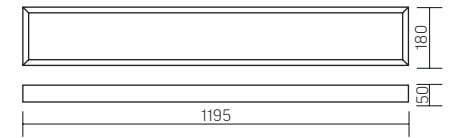

Package size of the lamp:  
1232×199×62mm  
PF ≥ 0,95



Article	Power	Light temperature	Luminous flux
V1-E0-00270-01000-XX03639	36W	3950K	4600lm

XX = 20 – lamp with degree of protection IP20  
XX = 40 – lamp with degree of protection IP40

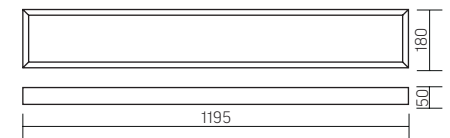
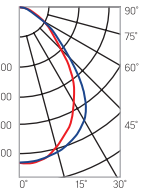

**Autonomous emergency lamp permanent action**

Emergency power supply unit, battery for 1 hour of autonomous operation, charge indicator, "Test" button in the set (see description on page 266)

**Conformity:**  
GOST IEC 60598-2-22-2012 "Fixtures. Part 2-22.  
Private requirements. Fixtures for emergency lighting "SP 52. 13330. 2011" Natural and artificial lighting "(updated edition of SNiP 23.05-95)

Article	Power	Light temperature	Luminous flux
V1-E0-00270-01A00-XX03639	36W	3950K	4600lm

XX = 20 – lamp with degree of protection IP20  
XX = 40 – lamp with degree of protection IP40

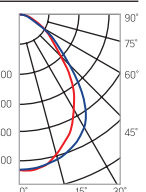

Diffuser (optional)  
Pack size of diffuser (2 pcs.):  
610×610×16mm

Article	Type	Diffuser size
V2-A0-PR00-00.2.0017.25	Prism standart	1189×174mm
V2-A0-0P00-03.2.0017.15	Opal	1189×174mm
V2-A0-PS00-00.2.0017.20	Pin Spot	1189×174mm
V2-A0-CI00-00.2.0017.20	Crushed ice	1189×174mm
V2-A0-MP00-02.2.0017.20	Microprism	1189×174mm

\*Luminous Flux Set excluding the diffuser

**Installation:**

Embedded in Armstrong suspended ceilings or mounted on a flat surface.

**Case:**

All-metal housing made of sheet steel with white powder coating

**Application:**

Preschool, school, secondary special, higher and other educational institutions

**Specifications:**

- Diode power 0,2W
- Index of color transmission Ra > 80
- Temperature range from + 1 ° C to + 40 ° C
- AC176-264V
- Network frequency 50Hz ± 10%
- LED life 50,000 hours
- 3 year warranty
- Luminous flux Kn ≤ 1%



## E220

1195×100×50mm

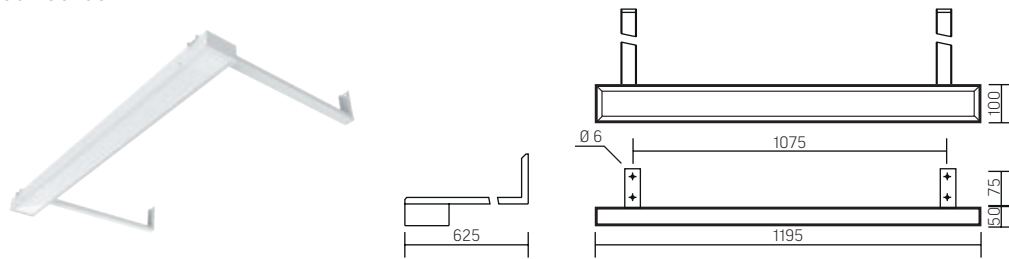

Package size of the lamp:  
1234×115×69mm  
PF ≥ 0,95



○ white

Article	Power	Light temperature	Luminous flux*
V1-E0-00270-60000-XX01839	18W	3950K	2100lm

XX = 20 – lamp with degree of protection IP20  
XX = 40 lamp with degree of protection IP40

Mounting bracket, with a set of fasteners (pack of 2 pcs.):

V4-E0-00.0005.SCO-0001	600mm
------------------------	-------

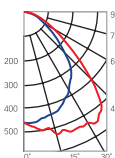

Diffuser (optional)  
The size of the packaging of the lens (2 pcs.):

Article	Type	Diffuser size
V2-A0-PR00-00.2.0016.25	Prism standart	1189×96mm
V2-A0-OP00-03.2.0016.15	Opal	1189×96mm
V2-A0-PS00-00.2.0016.20	Pin Spot	1189×96mm
V2-A0-CI00-00.2.0016.20	Crushed ice	1189×96mm
V2-A0-MP00-02.2.0016.20	Microprism	1189×96mm

\*Luminous Flux Set excluding the diffuser



### Installation:

Mounted on a vertical surface with brackets

### Case:

All-metal housing made of sheet steel with white powder coating

### Packaging:

Mounting bracket with a set of fasteners supplied separately

### Specifications:

Diode power 0,2W

Index of color transmission Ra > 80

Temperature range from + 1 ° C to + 40 ° C

AC176-264V

Network frequency 50Hz ± 10%

LED life 50,000 hours

3 year warranty

Luminous flux Kn ≤ 1%



To provide a standard indicator of the illumination of the school blackboard, we recommend using the "Chipped ice" diffuser».





## S070

595×620×65mm

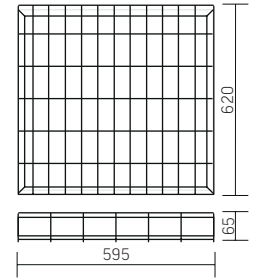

Package size of the lamp:  
635×614×67mm  
PF ≥ 0,95



○ white

Article	Power	Light temperature	Luminous flux*
V1-E0-00024-20000-XX03640	36W	4000K	4000lm
V1-E0-00024-20000-XX03665	36W	6500K	4200lm
V1-E0-00024-20000-XX05440	54W	4000K	6300lm
V1-E0-00024-20000-XX05465	54W	6500K	6600lm

XX = 20 – lamp with degree of protection IP20  
XX = 40 lamp with degree of protection IP40

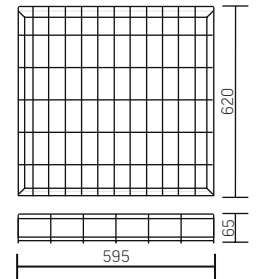

### Installation:

Mounted on a flat surface.

### Case:

All-metal housing made of sheet steel with white powder coating  
Protected by metal grill

### Packaging:

The grid is supplied

### Application:

For sports facilities where protection of the luminaire against the ingress of a sports projectile 54W for rooms with high ceilings is required

### Specifications:

Index of color transmission Ra > 80  
Temperature range from + 1 ° C to + 40 ° C  
AC176-264V  
Network frequency 50Hz ± 10%  
LED life 50,000 hours  
3 year warranty  
Luminous flux ≤ 1%



### Autonomous emergency lamp permanent action

Emergency power supply unit, battery for 1 hour of autonomous operation, charge indicator, "Test" button in the set (see description on page 266)

### Conformity:

GOST IEC 60598-2-22-2012 "Luminaries. Part 2-22.  
Private requirements. Luminaries for emergency lighting "SP 52. 13330. 2011" Natural and artificial lighting "(updated edition of SNiP 23.05-95)



Diffuser (optional)  
Pack size of diffuser (2 pcs.):  
610×610×16mm

Article	Power	Light temperature	Luminous flux*
V1-E0-00024-20A00-XX03640	36W	4000K	4000lm
V1-E0-00024-20A00-XX03665	36W	6500K	4200lm
V1-E0-00024-20A00-XX05440	54W	4000K	6300lm
V1-E0-00024-20A00-XX05465	54W	6500K	6600lm

XX = 20 – lamp with degree of protection IP20  
XX = 40 lamp with degree of protection IP40

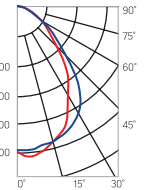

Article	Type	Diffuser size
V2-A0-PR00-00.2.0007.25	Prism standart	588×588mm
V2-A0-0P00-03.2.0007.15	Opal	588×588mm
V2-A0-PS00-00.2.0007.20	Pin Spot	588×588mm
V2-A0-CI00-00.2.0007.20	Crushed ice	588×588mm
V2-A0-MP00-02.2.0007.20	Microprism	588×588mm

\*Luminous Flux Set excluding the diffuser







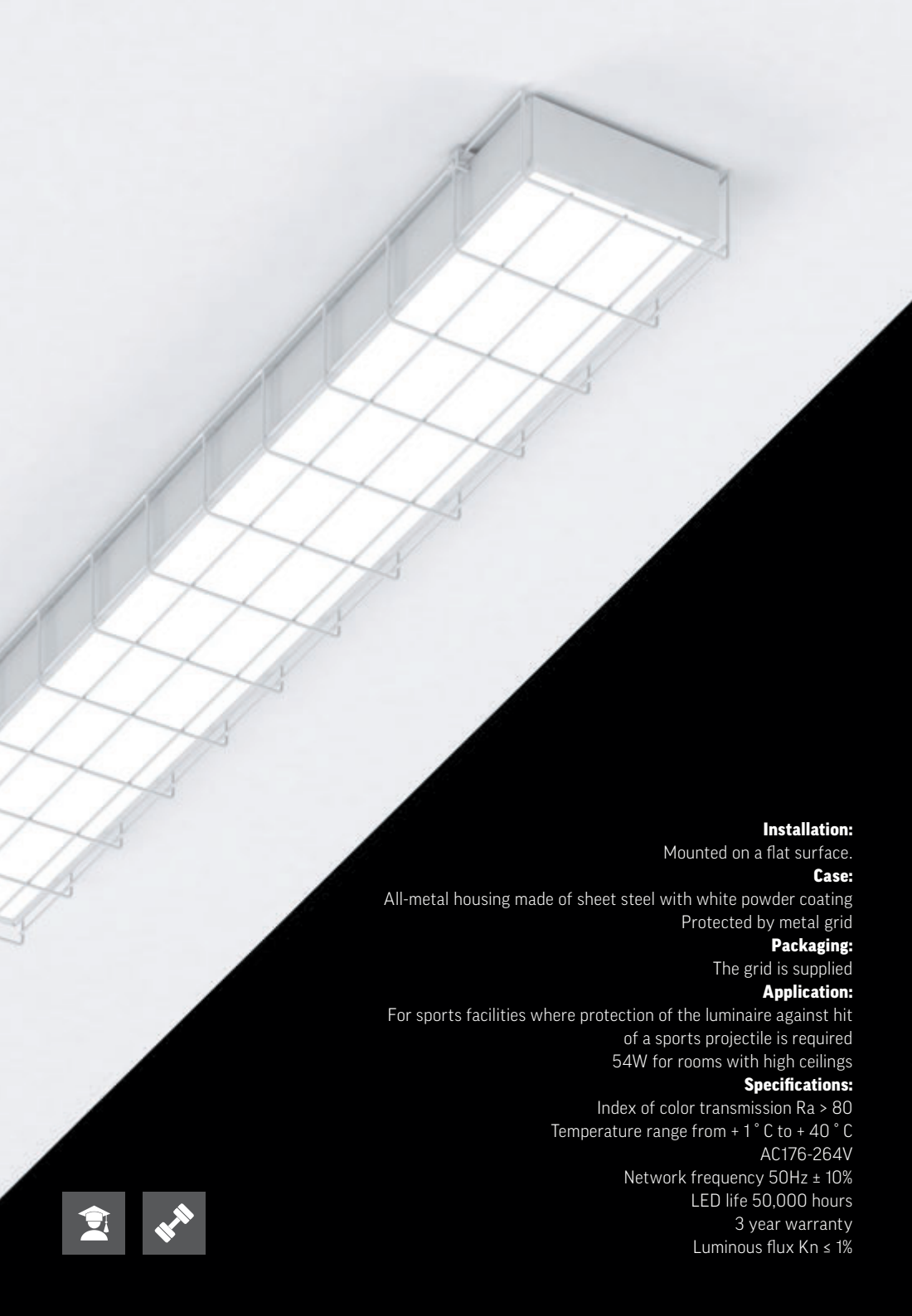

**S270**  
1195×200×65mm

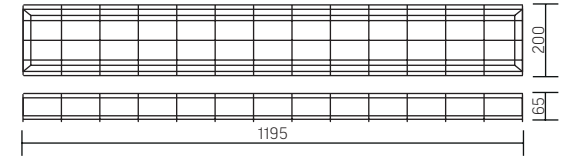
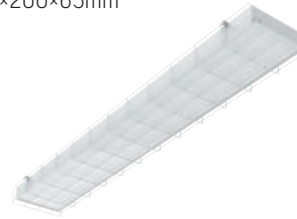

Package size of the lamp:  
1232×199×62mm  
PF ≥ 0,95



Article	Power	Light temperature	Luminous flux*
V1-E0-00066-20000-XX03640	36W	4000K	3800lm
V1-E0-00066-20000-XX03665	36W	6500K	4000lm
V1-E0-00066-20000-XX05440	54W	4000K	5700lm
V1-E0-00066-20000-XX05465	54W	6500K	5900lm

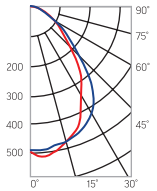

XX = 20 – lamp with degree of protection IP20  
XX = 40 – lamp with degree of protection IP40

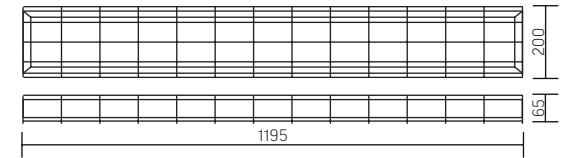

**A** Autonomous emergency lamp permanent action

Emergency power supply unit, battery for 1 hour of autonomous operation, charge indicator, –Test button in the set

**Conformity:**  
GOST IEC 60598-2-22:2012 –Luminaries. Part 2-22.  
Private requirements. Luminaries for emergency lighting SP 52. 13330. 2011– Natural and artificial lighting (updated edition of SNiP 23.05-95)

Article	Power	Light temperature	Luminous flux*
V1-E0-00066-20A00-XX03640	36W	4000K	3800lm
V1-E0-00066-20A00-XX03665	36W	6500K	4000lm
V1-E0-00066-20A00-XX05440	54W	4000K	5700lm
V1-E0-00066-20A00-XX05465	54W	6500K	5900lm

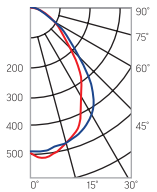

XX = 20 – lamp with degree of protection IP20  
XX = 40 – lamp with degree of protection IP40

- Installation:**  
Mounted on a flat surface.
- Case:**  
All-metal housing made of sheet steel with white powder coating  
Protected by metal grid
- Packaging:**  
The grid is supplied
- Application:**  
For sports facilities where protection of the luminaire against hit of a sports projectile is required  
54W for rooms with high ceilings
- Specifications:**  
Index of color transmission Ra > 80  
Temperature range from + 1 ° C to + 40 ° C  
AC176-264V  
Network frequency 50Hz ± 10%  
LED life 50,000 hours  
3 year warranty  
Luminous flux Kn ≤ 1%



Diffuser (optional)  
Pack size of diffuser (2 pcs.):  
610×610×16mm

Article	Type	Diffuser size
V2-A0-PR00-00.2.0017.25	Prism standard	1189×174mm
V2-A0-OP00-03.2.0017.15	Opal	1189×174mm
V2-A0-PS00-00.2.0017.20	Pin spot	1189×174mm
V2-A0-CI00-00.2.0017.20	Crushed ice	1189×174mm
V2-A0-MP00-02.2.0017.20	Microprism	1189×174mm

\* Luminous Flux Set excluding the diffuser



**S170**  
595×200×65mm

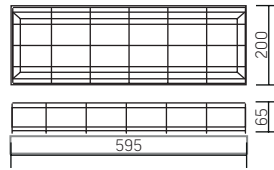

Package size of the lamp (2 pcs.):  
1232×199×62mm  
PF ≥ 0,95



○ white

Article	Power	Light temperature	Luminous flux*
V1-E0-00067-20000-XX01840	18W	4000K	1900lm
V1-E0-00067-20000-XX01865	18W	6500K	2000lm

XX = 20 – lamp with degree of protection IP20  
XX = 40 – lamp with degree of protection IP40

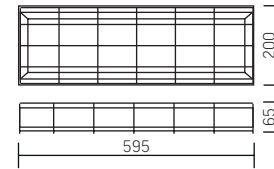
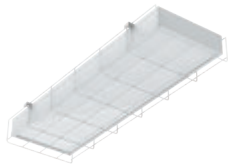
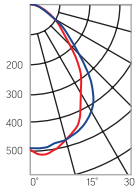

**A** **Autonomous emergency lamp permanent action**

Emergency power supply unit, battery for 1 hour of autonomous operation, charge indicator, –Test button in the set

**Conformity:**  
GOST IEC 60598-2-22-2012 –Luminaries. Part 2-22.

Private requirements. Luminaries for emergency lighting SP 52. 13330. 2011– Natural and artificial lighting (updated edition of SNIP 23.05-95)

Article	Power	Light temperature	Luminous flux*
V1-E0-00067-20A00-XX01840	18W	4000K	1900lm
V1-E0-00067-20A00-XX01865	18W	6500K	2000lm

XX = 20 – lamp with degree of protection IP20  
XX = 40 – lamp with degree of protection IP40

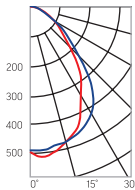

Diffuser (optional)  
Pack size of diffuser (2 pcs.):  
610×610×16mm

Article	Type	Diffuser size
V2-A0-PR00-00.2.0008.25	Prism standard	590×174mm
V2-A0-OP00-03.2.0008.15	Opal	590×174mm
V2-A0-PS00-00.2.0008.20	Pin spot	590×174mm
V2-A0-CI00-00.2.0008.20	Crushed ice	590×174mm
V2-A0-MP00-02.2.0008.20	Microprism	590×174mm

\* Luminous Flux Set excluding the diffuser

**Installation:**

Mounted on a flat surface.

**Case:**

All-metal housing made of sheet steel with white powder coating  
Protected by metal grid

**Packaging:**

The grid is supplied

**Application:**

For sports facilities where protection of the luminaire against hit of a sports projectile is required

**Specifications:**

Index of color transmission Ra > 80

Temperature range from + 1 °C to + 40 °C

AC176-264V

Network frequency 50Hz ± 10%

LED life 50,000 hours

3 year warranty

Luminous flux ≤ 1





## LIGHTING OF HOUSING AND UTILITIES SECTOR

## TAB

270x270x57mm

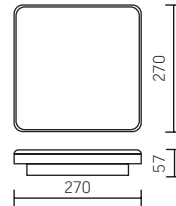

Lamp Size: 270x270x57 mm  
 Package size of the lamp:  
 100x100x90 mm  
 PF ≥0,90



○ white

Article	Power	Light temperature	Luminous flux*
V1-U0-00498-21000-6502030	20W	3000K	1800 lm
V1-U0-00498-21000-6502040	20W	4000K	2000 lm
V1-U0-00498-21000-6502050	20W	5000K	2000 lm

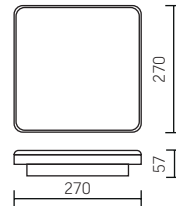
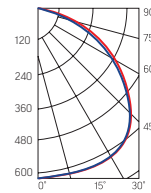

### Autonomous emergency lamp permanent action

Emergency power supply unit, battery for 1 hour of autonomous operation, charge indicator, -Test button in the set

#### Conformity:

GOST IEC 60598-2-22-2012 – Luminaries. Part 2-22. Private requirements. Luminaries for emergency lighting SP 52. 13330. 2011– Natural and artificial lighting (updated edition of SNIP 23.05-95)

○ white

Article	Power	Light temperature	Luminous flux*
V1-U0-00498-21A00-6502040	20W	4000K	2000 lm
V1-U0-00498-21A00-6502050	20W	5000K	2000 lm

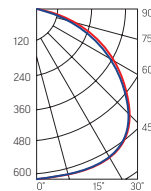

NEW MODEL



#### Installation:

The lamp is installed on a flat horizontal or vertical surface. Mounting bracket included in delivery

#### Case:

Polycarbonate

#### Diffuser:

Opal Polycarbonate

#### Specifications:

Index of color transmission Ra > 80

Temperature range from -20 ° C to + 40 ° C

AC220-240V

Network frequency 50Hz +/- 10%

LED life 50,000 hours

3 year warranty

Luminous flux <5%

Light angle 120 °

IK08



## NERO

300×83mm

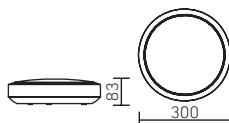

Package size of the lamp:  
335×120×355mm  
PF ≥ 0,9



NEW MODEL	Article	Power	Light temperature	Luminous flux*
	V1-U0-00086-21000-6501540	15W	4000K	1500 lm
	V1-U0-00086-21000-6501550	15W	5000K	1500 lm
NEW MODEL	V1-U0-00086-21000-6502540	25W	4000K	2500 lm
	V1-U0-00086-21000-6502550	25W	5000K	2500 lm

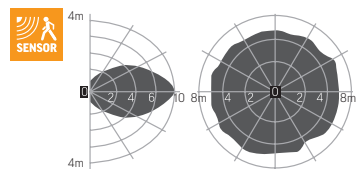
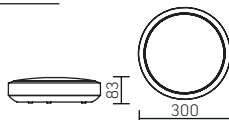
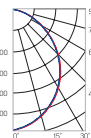

Article	Power	Light temperature	Luminous flux*
V1-U0-00086-21S00-6501550	15W	4000K	1500 lm
V1-U0-00086-21S00-6502550	15W	5000K	1500 lm

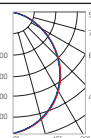

### Luminaire operation mode with sensor:

The lamp is equipped with a microwave motion sensor and turns on for 30 seconds when motion is detected in the zone of the sensor operation.

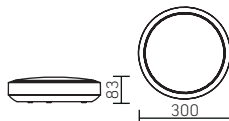

### Autonomous emergency lamp permanent action

Emergency power supply unit, battery for 1,5 hour of autonomous operation, charge indicator, –Test button in the set.



NEW MODEL	Article	Power	Light temperature	Luminous flux*
	V1-U0-00086-21A00-6501540	15W	4000K	1500 lm
	V1-U0-00086-21A00-651650	15W	5000K	1500 lm
NEW MODEL	V1-U0-00086-21A00-6502540	25W	4000K	2500 lm
	V1-U0-00086-21A00-6502550	25W	5000K	2500 lm

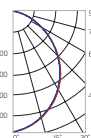

**Conformity:** GOST IEC 60598-2-22-2012 –Luminaries. Part 2-22. Private requirements. Luminaries for emergency lighting SP 52. 13330. 2011– Natural and artificial lighting (updated edition of SNIP 23.05-95)

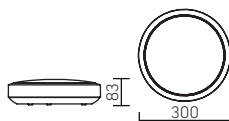

**DALI** Package size of the lamp:  
335×120×355mm  
PF ≥ 0,9



NEW MODEL	Article	Power	Light temperature	Luminous flux*
	V1-U0-00086-21D01-6501540	15W	4000K	1500 lm
	V1-U0-00086-21D01-6501550	15W	5000K	1500 lm
	V1-U0-00086-21D01-6502540	25W	4000K	2500 lm
NEW MODEL	V1-U0-00086-21D01-6502550	25W	5000K	2500 lm

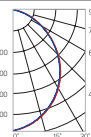

NEW MODEL



### Installation:

Mounted on a horizontal or vertical surface.  
Mounting kit included

### Case:

High impact self-extinguishing ABS plastic  
White matte PMMA diffuser

### Application:

The luminaire is used to illuminate residential infrastructure, out-buildings, adjacent areas, underground pedestrian crossings

### Specifications:

Index of color transmission Ra > 80  
Temperature range from -30 ° C to + 40 ° C  
Network frequency 50Hz ± 10%  
LED life 50,000 hours

3 year warranty  
Luminous flux Kn ≤ 15%

Operating mode of luminaires with a sensor:  
Lamps are turned on when motion is detected in the working area of the microwave sensor

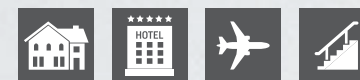



## AERO

300×85mm

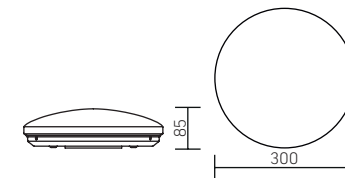

Package size of the lamp:  
325×325×105mm  
PF ≥ 0,90 для 21W  
PF ≥ 0,85 для 16W



NEW MODEL

Article	Power	Light temperature	Luminous flux*
V1-U0-00362-21000-4401630	16W	3000K	1100 lm
V1-U0-00362-21000-4401640	16W	4000K	1100 lm
V1-U0-00362-21000-4401650	16W	5000K	1100 lm
V1-U0-00362-21000-4402130	21W	3000K	1600 lm
V1-U0-00362-21000-4402140	21W	4000K	1600 lm
V1-U0-00362-21000-4402150	21W	5000K	1600 lm

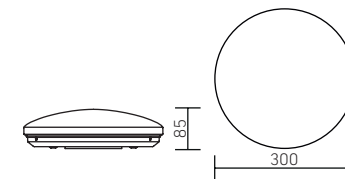
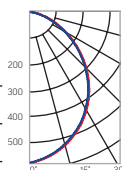

NEW MODEL

Article	Power	Light temperature	Luminous flux*
V1-U0-00362-21S00-4401630	16W	3000K	1100 lm
V1-U0-00362-21S00-4401640	16W	4000K	1100 lm
V1-U0-00362-21S00-4401650	16W	5000K	1100 lm
V1-U0-00362-21S00-4402130	21W	3000K	1600 lm
V1-U0-00362-21S00-4402140	21W	4000K	1600 lm
V1-U0-00362-21S00-4402150	21W	5000K	1600 lm

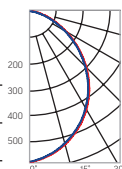

### Installation:

Mounted on a horizontal or vertical surface  
Mounting kit included

### Case:

White metal body  
White matte PMMA diffuser

### Specifications:

Index of color transmission Ra > 80  
Temperature range from + 1 °C to + 40 °C  
AC220-240V  
Network frequency 50Hz ± 10%  
LED life 50,000 hours  
3 year warranty  
Luminous flux ≤ 15%



### Luminaire operation mode with sensor

The default settings:  
when the level of illumination in the area of the sensor is more than 50 lk, the lamp does not turn on when moving  
- when the level of illumination in the area of the sensor is less than 50 lk and in the absence of movement the lamp does not turn on  
- at the level of illumination in the zone of operation of the sensor and when motion is detected, the lamp turns on for 90 seconds, and when there is no movement after 90 seconds, the lamp turns off until the movement is resumed

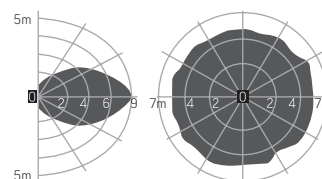

## Lighting of housing and utilities sector

224x90x52mm

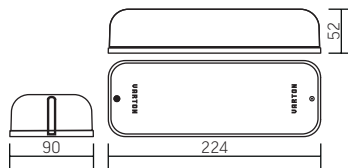

Package size of the lamp:

240x112x64mm

PF ≥ 0,85



○ white

Article	Power	Light temperature	Luminous flux*
<b>NEW MODEL</b> V1-U0-00006-21000-6500840	8W	4000K	900 lm
V1-U0-00006-21000-6500850	8W	5000K	900 lm
<b>NEW MODEL</b> V1-U0-00006-21000-6501240	12W	4000K	1200 lm
V1-U0-00006-21000-6501250	12W	5000K	1200 lm

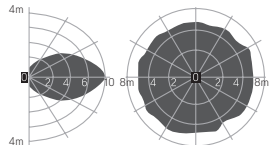
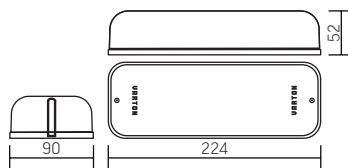
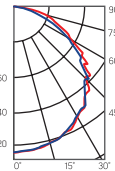

Article	Power	Light temperature	Luminous flux*
<b>NEW MODEL</b> V1-U0-00006-21S00-6501240	12W	4000K	1200 lm
V1-U0-00006-21S00-6501250	12W	5000K	1200 lm

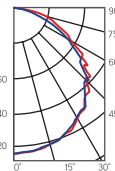

Sensor active area

□ ○ white

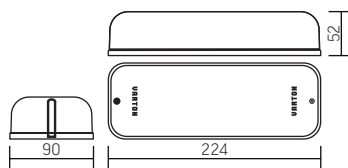

### Application:

Premises with increased electrical safety requirements

DC 24-36V

AC 24V

PF ≥ 0,85

Article	Power	Light temperature	Luminous flux*
<b>NEW MODEL</b> V1-U0-00006-21N00-6501240	12W	4000K	1200 lm
V1-U0-00006-21N00-6501250	12W	5000K	1200 lm

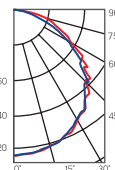

○ white

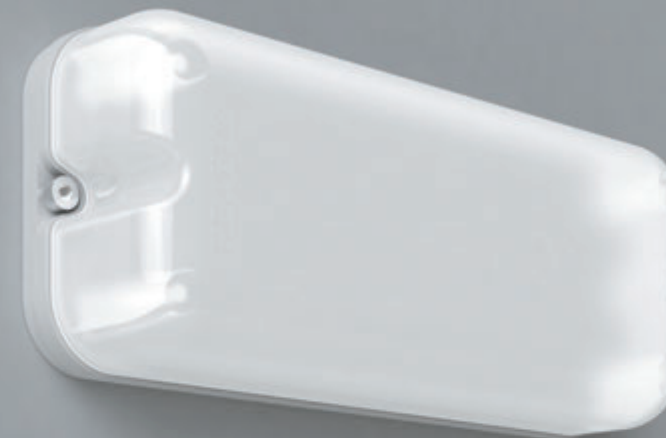

### Installation:

Mounted on a horizontal or vertical surface.

The lamp is mounted with screws to the base with pre-installed dowels.

### Case:

High impact self-extinguishing ABS plastic

Complete with cable entry, which has high wear resistance

To ensure the degree of protection IP65, the junction of the body to the diffuser is sealed with a sealant

### Diffuser:

Shock-resistant matte self-extinguishing PC plastic (polycarbonate) with UV stabilizer additives

### Specifications:

Index of color transmission Ra > 80

Temperature range from -25 ° C to + 40 ° C

Network frequency 50Hz ± 10%

LED life 50,000 hours

3 year warranty

Luminous flux luminaire ≤ 15%







## Lighting of housing and utilities sector

185×70mm

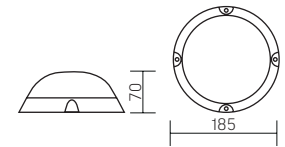

Package size of the lamp:

190×190×85mm

PF ≥ 0,85



○ white

Article	Power	Light temperature	Luminous flux*
V1-U0-00005-21000-6500640	6W	4000K	900 lm
V1-U0-00005-21000-6500650	6W	5000K	900 lm
V1-U0-00005-21000-6501040	10W	4000K	1000 lm
V1-U0-00005-21000-6501050	10W	5000K	1000 lm

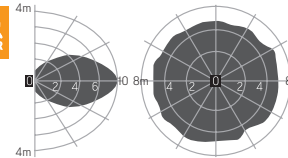
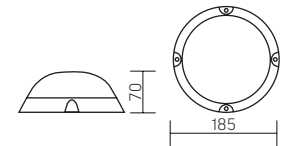
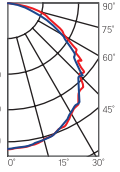

Article	Power	Light temperature	Luminous flux*
V1-U0-00005-21S00-6501040	10W	4000K	1000 lm
V1-U0-00005-21S00-6501050	10W	5000K	1000 lm

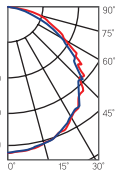

Sensor active area



○ white

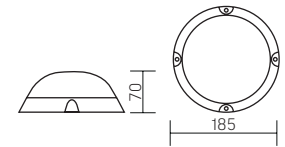

### Application:

Premises with increased electrical safety requirements  
DC 24-36V  
AC 24V  
PF ≥ 0,85

Article	Power	Light temperature	Luminous flux*
V1-U0-00005-21N00-6501040	10W	4000K	1000 lm
V1-U0-00005-21N00-6501050	10W	5000K	1000 lm

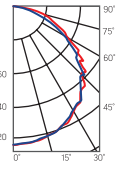

○ white

### Installation:

Mounted on a horizontal or vertical surface.

The lamp is mounted with screws to the base with pre-installed dowels.

### Case:

High impact self-extinguishing ABS plastic

Complete with cable entry, which has high wear resistance

To ensure the degree of protection IP65, the junction of the body to the diffuser is sealed with a sealant

### Diffuser:

Shock-resistant matte self-extinguishing PC plastic (polycarbonate) with UV stabilizer additives

### Specifications:

Index of color transmission Ra > 80

Temperature range from -25 ° C to + 40 ° C

Network frequency 50Hz ± 10%

LED life 50,000 hours

3 year warranty

Luminous flux luminaire ≤ 15%



# LUX

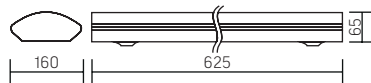

Lamp Size: 1235×160×65mm  
 Package size of the lamp:  
 634×188×90mm  
 PF ≥ 0,95



○ white

Article	Power	Light temperature	Luminous flux*
V1-U0-00030-20000-2001830	18W	3000K	1300lm
V1-U0-00030-20000-2001840	18W	4000K	1400lm
V1-U0-00030-20000-2001865	18W	6500K	1500lm

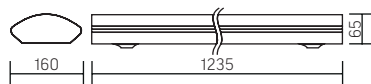
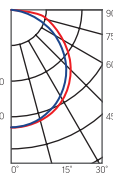

Lamp Size: 625×160×65mm  
 Package size of the lamp:  
 1236×183×91mm  
 PF ≥ 0,95

○ white

Article	Power	Light temperature	Luminous flux*
V1-U0-00044-20000-2003630	36W	3000K	2800lm
V1-U0-00044-20000-2003640	36W	4000K	2900lm
V1-U0-00044-20000-2003665	36W	6500K	3000lm

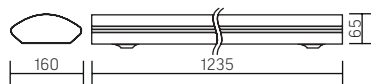
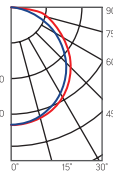

## Autonomous emergency lamp permanent action

Emergency power supply unit battery for 1 hour of autonomous operation, charge indicator, –Test button in the set (see description on page 266)

### Conformity:

GOST IEC 60598-2-22-2012 – Luminaires. Part 2-22. Private requirements. Luminaires for emergency lighting SP 52. 13330. 2011– Natural and artificial lighting (updated edition of SNIP 23.05-95)

Article	Power	Light temperature	Luminous flux*
V1-U0-00030-20A00-2001840	18W	4000K	1400lm
V1-U0-00044-20A00-2003640	36W	4000K	2900lm
V1-U0-00044-20A00-2003665	36W	6500K	3000lm

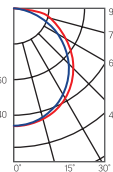

### Installation:

Mounted on a horizontal or vertical surface. Several luminaires can be connected in a single line due to a well-thought-out and convenient design.

### Case:

All-metal housing made of sheet steel with white powder coating

### Diffuser:

Opal light scattering polycarbonate

### Specifications:

Index of color transmission Ra > 80  
 Temperature range from + 1 ° C to + 40 ° C  
 AC176-264V  
 Network frequency 50Hz ± 10%  
 LED life 50,000 hours  
 3 year warranty  
 Luminous flux Kn ≤ 1%





**PANELS**



# PANELS

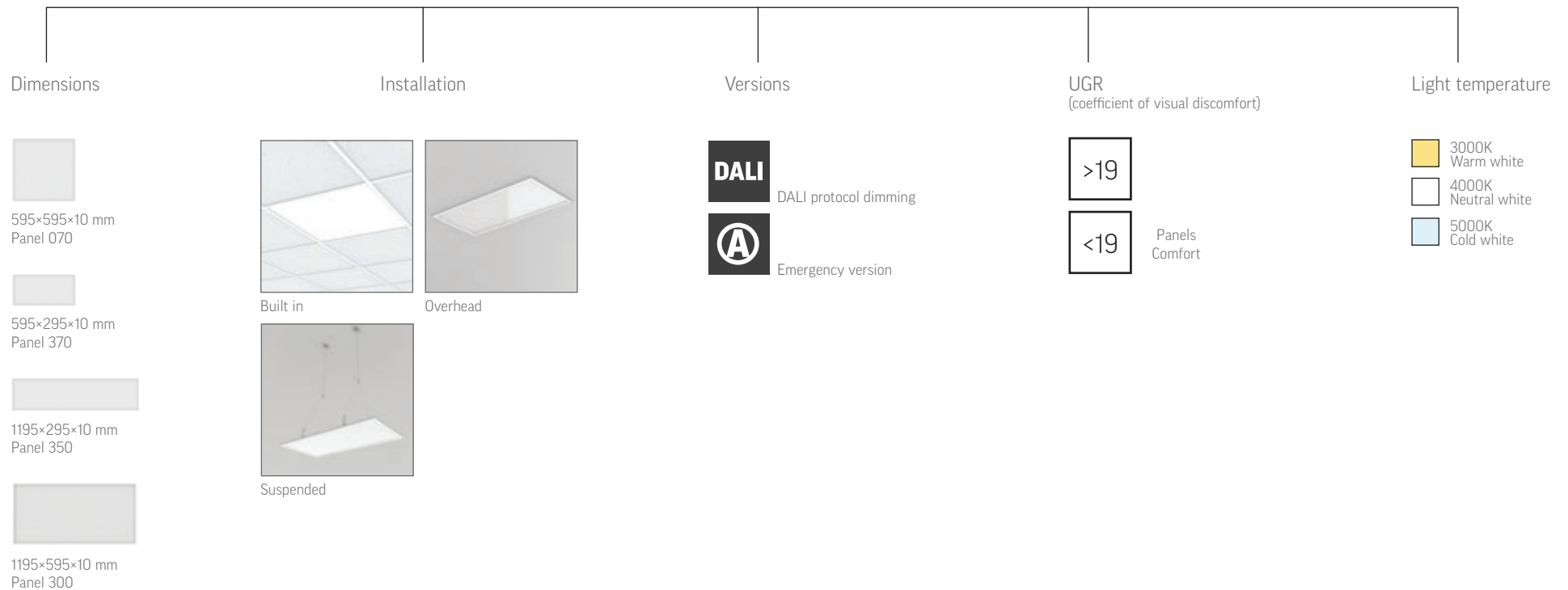

## Panel 300

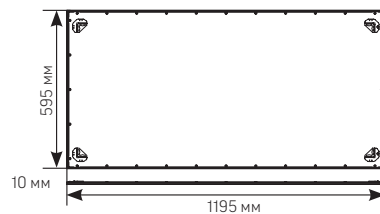

Lamp Size: 1195x595x10 mm  
 Package size of the lamp:  
 1222x602x42 mm  
 PF ≥ 0,95



○ white

Article	Power	Light temperature	Luminous flux
LD936562250	50W	4000K	5000 lm

## Accessories for LED panels Varton



Article	Name
V4-A0-70.0018.PNL-0002	Mounting kit for mounting panels in plasterboard ceilings v.2



Article	Name
V4-A0-70.0018.PNL-0003	Suspension kit for LED panels with adjustable cable height (maximum length 0,6m)

NEW MODEL



### Installation:

Surface mounting, mounting included in the package

Embedded installation

Installation in the FCL (mounting kit is ordered separately)

Suspended installation (suspension kit ordered separately)

### Case:

Aluminum

### Diffuser:

Polypropylene

### Specifications:

Index of color transmission Ra > 80

Temperature range from + 1 ° C to + 40 ° C

AC220-240V

Network frequency 50Hz +/- 10%

LED life 50,000 hours

3 year warranty

Luminous flux <1%

Light angle 115 °



NEW  
MODEL



## Panel 370

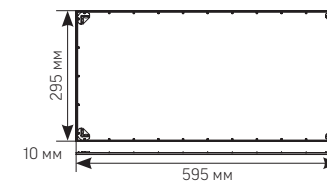

Lamp Size: 595x295x10 mm  
 Package size of the lamp:  
 627x321x66 mm  
 PF ≥0,95



○ white

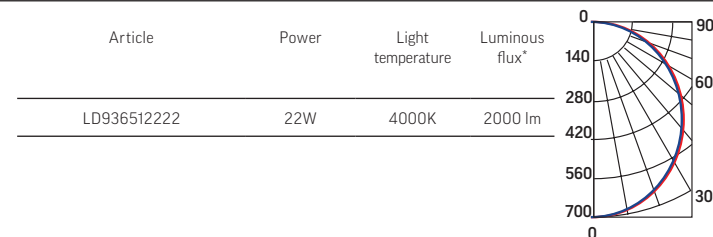

## Accessories for LED panels Varton



Article	Name
V4-A0-70.0018.PNL-0002	Mounting kit for mounting panels in plasterboard ceilings v.2



Article	Name
V4-A0-70.0018.PNL-0003	Suspension kit for LED panels with adjustable cable height (maximum length 0,6m)

### Installation:

Surface mounting, mounting included in the package  
 Embedded installation Installation in the FCL (mounting kit is ordered separately)  
 Suspended installation (suspension kit ordered separately)

### Case:

Aluminum

### Diffuser:

Polypropylene

### Specifications:

Index of color transmission Ra > 80

Temperature range from + 1 ° C to + 40 ° C

AC220-240V

Network frequency 50Hz +/- 10%

LED life 50,000 hours

3 year warranty

Luminous flux <1%

Light angle 115 °



## Panel Comfort 350

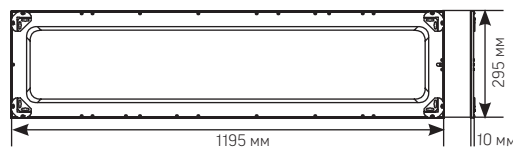

Lamp Size: 1195x295x11 mm

Package size of the lamp:

1200x600x18 mm

PF ≥ 0,90



○ white

Remote driver (ordered separately)

LD102-000-0-036

Article	Power	Light temperature	Luminous flux
LD936511236	36W	4000K	4000 lm

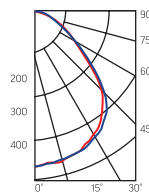

## Accessories for LED panels Varton



Article	Name
V4-A0-70.0018.PNL-0002	Mounting kit for mounting panels in plasterboard ceilings v.2



Article	Name
V4-A0-70.0018.PNL-0003	Suspension kit for LED panels with adjustable cable height (maximum length 0,6m)

NEW MODEL



### Installation:

Surface mounting, mounting included in the package

Embedded installation in suspended ceiling systems

Installation in the FCL (mounting kit is ordered separately)

Suspended installation (suspension kit ordered separately)

### Case:

Aluminum

### Diffuser:

Polystyrene

### Specifications:

Index of color transmission Ra > 82

UGR < 19

Temperature range from + 1 ° C to + 40 ° C

AC220-240V

Network frequency 50Hz +/- 10%

LED life 50,000 hours

3 year warranty

Luminous flux Kn < 1%

Light angle 90 °



NEW  
MODEL



## Panel Comfort 070

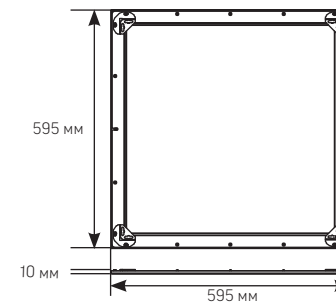

Lamp Size: 595x595x10 mm  
Package size of the lamp: 600x600x18 mm  
PF ≥0,90



○ white

Remote driver (ordered separately)  
LD102-000-0-033

Article	Power	Light temperature	Luminous flux
LD936511233	33W	4000K	3600 lm

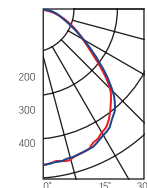

## Accessories for LED panels Varton



Article	Name
V4-A0-70.0018.PNL-0002	Mounting kit for mounting panels in plasterboard ceilings v.2



Article	Name
V4-A0-70.0018.PNL-0003	Suspension kit for LED panels with adjustable cable height (maximum length 0,6m)

### Installation:

Surface mounting, mounting included in the package  
Embedded installation in suspended ceiling systems  
Installation in the FCL (mounting kit is ordered separately)  
Suspended installation (suspension kit ordered separately)

### Case:

Aluminum

### Diffuser:

Polystyrene

### Specifications:

Index of color transmission Ra > 82

UGR <19

Temperature range from +1 °C to +40 °C

AC220-240V

Network frequency 50Hz +/- 10%

LED life 50,000 hours

3 year warranty

Luminous flux <1%

Light angle 90 °







## Panel 070

595×595×10mm

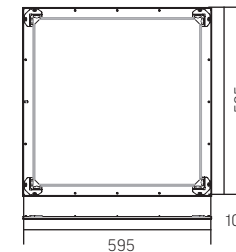

Package size of the lamp:  
600×600×18mm  
Power source package size:  
160×50×50mm  
PF ≥ 0,90



○ white

Article	Power	Light temperature	Luminous flux
LD936511443	34W	3000K	3000lm
LD936511243	34W	4000K	3200lm
LD936511334	34W	6500K	3200lm

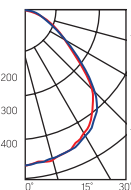

The remote driver (it is completed separately)

LD102-000-0-043

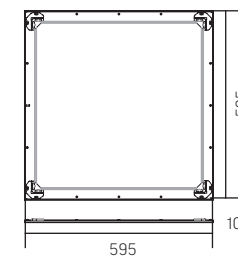

**DALI**

Article	Power	Light temperature	Luminous flux
LD9365D1443	34W	3000K	3000lm
LD9365D2243	34W	4000K	3200lm
LD9365D1334	34W	6500K	3200lm

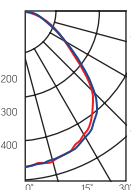

Driver included

### Installation:

The luminaire is built into suspended ceiling systems.

The possibility of overhead execution (mounting included)

Additional mounts for mounting in the gypsum board are ordered separately.

### Case:

Luminaire housing made of anodized aluminum

Opal Diffuser

The power source is completed in a separate box.

### Specifications:

Index of color transmission Ra > 80

Temperature range from + 1 ° C to + 40 ° C

Network frequency 50Hz ± 10%

LED life 50,000 hours

3 year warranty

Luminous flux Kn ≤ 5%



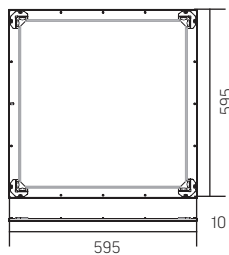

## Accessories for LED panels Varton



Article	Name
V4-A0-70.0018.PNL-0002	Mounting kit for mounting panels in plasterboard ceilings v.2



### Autonomous emergency lamp permanent action

Emergency power supply unit, battery for 1 hour of autonomous operation, charge indicator, –Test button in the set (see description on page 266)

Article	Power	Light temperature	Luminous flux
LD936511443EM	34W	3000K	3000lm
LD936511243EM	34W	4000K	3200lm
LD936511334EM	34W	6500K	3200lm

Driver included

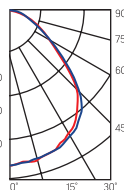

Article	Name
V4-A0-70.0018.PNL-0003	Suspension kit for LED panels with adjustable cable height (maximum length 0,6m)

### Conformity:

GOST IEC 60598-2-22-2012  
 –Luminaries. Part 2-22.  
 Private requirements. Luminaries for emergency lighting SP 52. 13330. 2011– Natural and artificial lighting "(updated edition of SNiP 23.05-95)





## ADMINISTRATIVE LIGHTING

## SOFT/OT Comfort

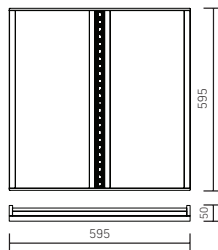

Lamp Size: 595x595x50 mm  
Package size of the lamp: 660x660x80 mm  
PF ≥0,95



○ white

Article	Power	Light temperature	Luminous flux
V1-A0-00558-10000-2003030	30W	3000K	2800 lm
V1-A0-00558-10000-2003040	30W	4000K	3000 lm

NEW  
MODEL

### Installation:

Lamps are built into suspended ceiling systems with a T profile of 24 mm width

### Case:

Aluminum, steel

### Diffuser:

PMMA

### Specifications:

Index of color transmission Ra > 83

Temperature range from +1 °C to +40 °C

AC220-240V

Network frequency 50Hz +/- 10%

LED life 50,000 hours

3 year warranty

Luminous flux Kn <5%

Light beam angle 65 °

UGR <15



# LINEA

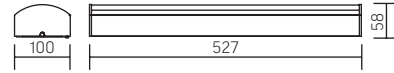

Lamp Size: 527x100x58 mm  
 Package size of the lamp:  
 600x110x60 mm  
 PF ≥ 0,90



○ white

Article	Power	Light temperature	Luminous flux
V1-A0-00472-20000-2002040	20W	4000K	2000lm

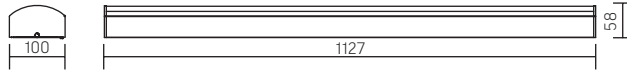
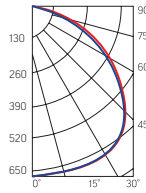

Lamp Size: 1127x100x58 mm  
 Package size of the lamp:  
 1200x110x60 mm  
 PF ≥ 0,90



○ white

Article	Power	Light temperature	Luminous flux
V1-A0-00473-20000-2004540	45W	4000K	4500lm

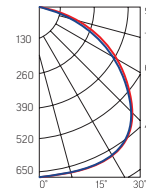

**NEW MODEL**



**Installation:**

Surface mounted

**Body Material:**

Aluminum

**Diffuser:**

Polycarbonate

**Specifications:**

Index of color transmission Ra > 80

Temperature range from + 1 ° C to + 40 ° C

AC220-240V

Network frequency 50Hz +/- 10%

LED life 50,000 hours

3 year warranty

Luminous flux Kn <5%

Light angle 115 °

IK10



NEW  
MODEL



## Solo



Lamp Size: 186x90mm  
Package size of the lamp:  
195x195x100mm  
PF ≥0,95



white

Article	Power	Light temperature	Luminous flux
V1-R0-00422-20000-2002530	25W	3000K	2400lm
V1-R0-00422-20000-2002540	25W	4000K	2500lm

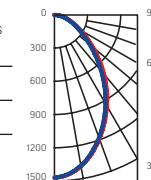

Lamp Size: 286x110mm Package size  
of the lamp:  
295x295x120mm  
PF ≥0,95



white

Article	Power	Light temperature	Luminous flux
V1-R0-00423-20000-2003530	35W	3000K	3400lm
V1-R0-00423-20000-2003540	35W	4000K	3500lm

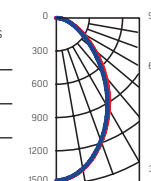

### Installation:

Overhead

### Body Material:

Aluminum (possible to paint the lamp in any RAL color)

### Diffuser material:

Polycarbonat

### Specifications:

Index of color transmission Ra > 83

Temperature range from + 1 ° to + 40 ° C

AC220-240V

Network frequency 50Hz +/- 10%

LED life 50,000 hours

3 year warranty

Luminous flux ≤ 5%

Angle of dispersion of a light stream 80 °



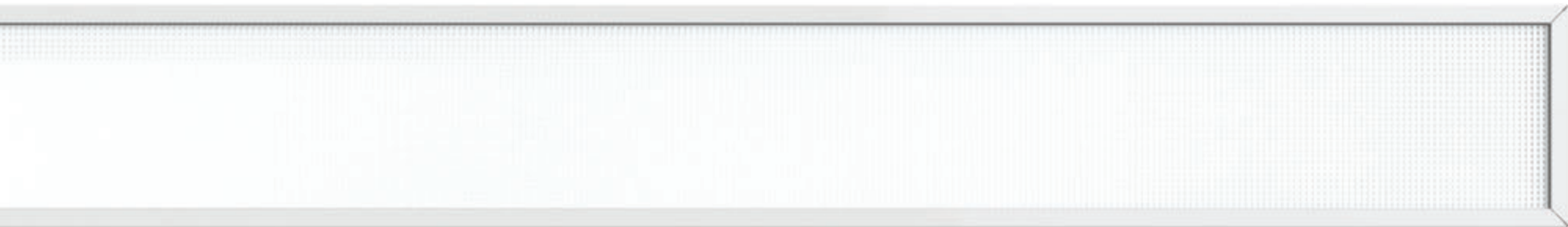

# LUMINARIES FOR ADMINISTRATIVE OBJECTS SERIES A

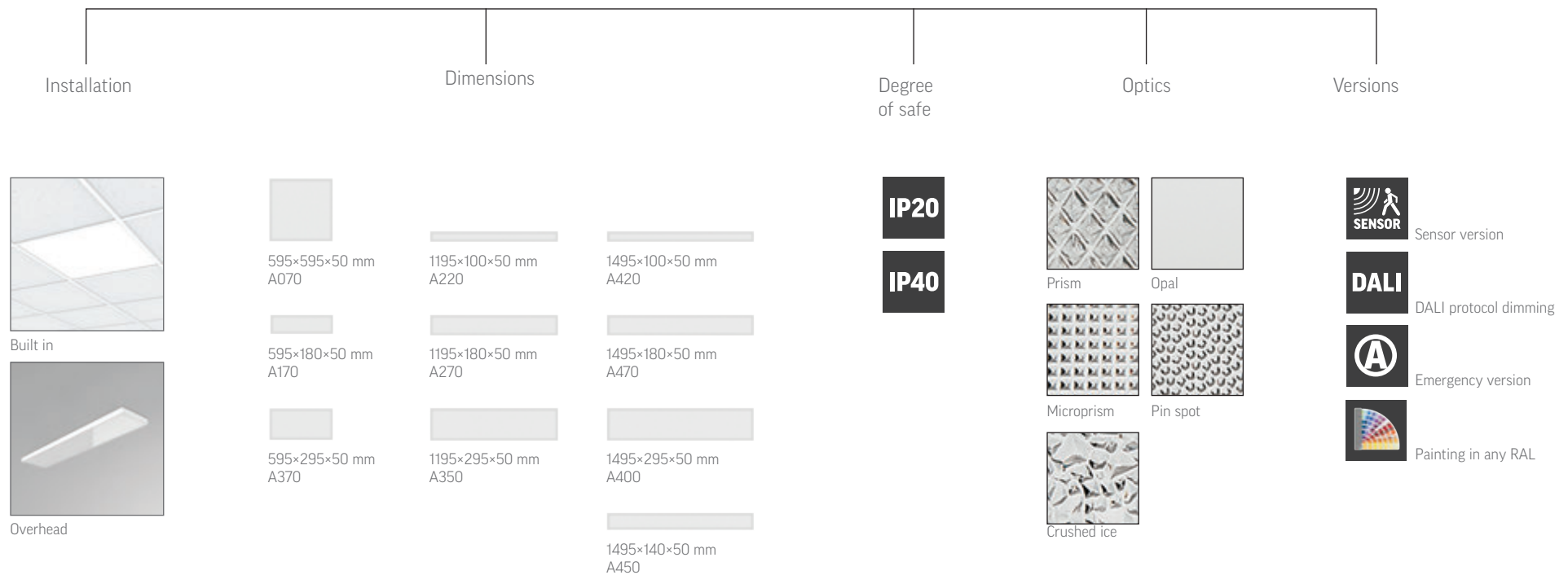

## A070 2.0

595×595×50 mm



Lamp Size:  
595×595×50 mm  
Package size of the lamp:  
615×615×60 mm  
PF ≥0,93



○ white



Article	Power	Light temperature	Luminous flux*	Diffuser
V1-A0-00070-010P0-4003030	30W	3000K	3000 lm	Opal
V1-A0-00070-01PR0-4003030	30W	3000K	3600 lm	Prism
V1-A0-00070-010P0-4004530	45W	3000K	4500 lm	Opal
V1-A0-00070-01PR0-4004530	45W	3000K	5500 lm	Prism
V1-A0-00070-010P0-40030XX	30W	4000K/5000K/6500K	3200 lm	Opal
V1-A0-00070-01PR0-40030XX	30W	4000K/5000K/6500K	3900 lm	Prism
V1-A0-00070-010P0-40045XX	45W	4000K/5000K/6500K	4700 lm	Opal
V1-A0-00070-01PR0-40045XX	45W	4000K/5000K/6500K	5800 lm	Prism

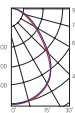

XX - 40 - LT 4000K  
XX - 50 - LT 5000K  
XX - 65 - LT 6500K

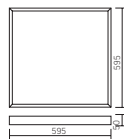

### Autonomous emergency lamp permanent action

Emergency power supply unit, battery for 1 hour of autonomous operation, charge indicator, -Test button in the set (see description on page 266)

#### Conformity:

GOST IEC 60598-2-22-2012 – Luminaires. Part 2-22.  
Private requirements. Luminaries for emergency lighting SP 52.  
13330. 2011– Natural and artificial lighting "(updated edition of SNiP 23.05-95)

Article	Power	Light temperature	Luminous flux*	Diffuser
V1-A0-00070-010PD-4003030	30W	3000K	3000 lm	Opal
V1-A0-00070-01PRD-4003030	30W	3000K	3600 lm	Prism
V1-A0-00070-010PD-4004530	45W	3000K	4500 lm	Opal
V1-A0-00070-01PRD-4004530	45W	3000K	5500 lm	Prism
V1-A0-00070-010PD-40030XX	30W	4000K/5000K/6500K	3200 lm	Opal
V1-A0-00070-01PRD-40030XX	30W	4000K/5000K/6500K	3900 lm	Prism
V1-A0-00070-010PD-40045XX	45W	4000K/5000K/6500K	4700 lm	Opal
V1-A0-00070-01PRD-40045XX	45W	4000K/5000K/6500K	5800 lm	Prism

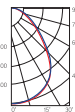

XX - 40 - LT 4000K  
XX - 50 - LT 5000K  
XX - 65 - LT 6500K



Application:  
Administrative premises in which more flexible lighting control is required

Article	Power	Light temperature	Luminous flux*	Diffuser
V1-A0-00070-010PA-4003030	30W	3000K	3000 lm	Opal
V1-A0-00070-01PRA-4003030	30W	3000K	3600 lm	Prism
V1-A0-00070-010PA-4004530	45W	3000K	4500 lm	Opal
V1-A0-00070-01PRA-4004530	45W	3000K	5500 lm	Prism
V1-A0-00070-010PA-40030XX	30W	4000K/5000K/6500K	3200 lm	Opal
V1-A0-00070-01PRA-40030XX	30W	4000K/5000K/6500K	3900 lm	Prism
V1-A0-00070-010PA-40045XX	45W	4000K/5000K/6500K	4700 lm	Opal
V1-A0-00070-01PRA-40045XX	45W	4000K/5000K/6500K	5800 lm	Prism

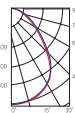

XX - 40 - LT 4000K, XX - 50 - LT 5000K, XX - 65 - LT 6500K

NEW MODEL

#### Installation:

The luminaire is mounted on a flat horizontal or vertical surface or embedded in suspended ceiling systems with a T profile of 24 mm width.

#### Case Material:

All-metal housing made of sheet steel with white powder coating

#### Diffuser:

Complete with opal or prismatic diffuser

#### Specifications:

Index of color transmission Ra > 82  
Temperature range from + 1 ° C to + 40 ° C  
AC176-264V  
Network frequency 50Hz +/- 10%  
LED life 50,000 hours  
3 year warranty  
Luminous flux Kn <3%





## A070

595×595×50mm

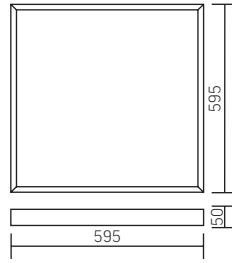

Application:  
Administrative premises in which more flexible lighting control is required

Article	Power	Light temperature	Luminous flux
V1-A0-00070-01D01-XX03630	36W	3000K	4400 lm
V1-A0-00070-01D01-XX03640	36W	4000K	4600 lm
V1-A0-00070-01D01-XX03650	36W	5000K	4600 lm
V1-A0-00070-01D01-XX03665	36W	6500K	4700 lm

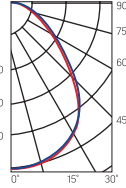

XX = 20 – lamp with degree of protection IP20  
XX = 40 – lamp with degree of protection IP40

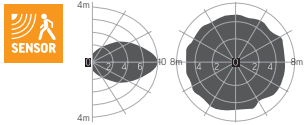
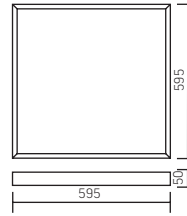

Application:  
Administrative premises where constant lighting is not required

Article	Power	Light temperature	Luminous flux*
V1-A0-00070-01S00-XX02740	27W	4000K	3500 lm
V1-A0-00070-01S00-XX02750	27W	5000K	3500 lm
V1-A0-00070-01S00-XX02765	27W	6500K	3600 lm
V1-A0-00070-01S00-XX03640	36W	4000K	4600 lm
V1-A0-00070-01S00-XX03650	36W	5000K	4600 lm
V1-A0-00070-01S00-XX03665	36W	6500K	4700 lm

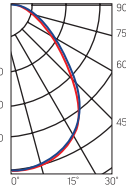

XX = 20 – lamp with degree of protection IP20  
XX = 40 – lamp with degree of protection IP40



Diffuser (optional)  
Pack size of diffuser (2 pcs.):  
610×610×16mm

Article	Type	Diffuser size
V2-A0-PR00-00.2.0007.25	Prism standard	588×588mm
V2-A0-OP00-03.2.0007.15	Opal	588×588mm
V2-A0-PS00-00.2.0007.20	Pin spot	588×588mm
V2-A0-CI00-00.2.0007.20	Crushed ice	588×588mm
V2-A0-MP00-02.2.0007.20	Microprism	588×588mm

\* Luminous Flux Set excluding the diffuser



NEW  
MODEL



## A070/N Overhead lamp with uniform illumination

610×610×56 mm

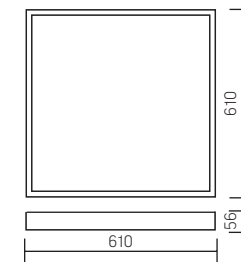

Lamp Size: 610×610×56 mm  
Package size of the lamp:  
615×615×66 mm  
PF ≥0,95



Article	Power	Light temperature	Luminous flux
V1-A0-20070-01HG0-4003630	36W	3000K	3400 lm
V1-A0-20070-01HG0-4003640	36W	4000K	3600 lm
V1-A0-20070-01HG0-4005030	50W	3000K	4400 lm
V1-A0-20070-01HG0-4005040	50W	4000K	4600 lm

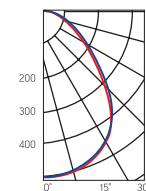

### Installation:

The lamp is installed on a flat horizontal or vertical surface.

### Case Material:

All-metal housing made of sheet steel with white powder coating

### Diffuser:

Complete with opal diffuser

### Specifications:

Index of color transmission Ra > 82

Temperature range from + 1 ° C to + 40 ° C

AC176-264V

Network frequency 50Hz +/- 10%

LED life 50,000 hours

3 year warranty

Luminous flux Kn <1%



**A070/N Tunable White DALI**  
**Overhead lamps with uniform illumination**

610×610×56 mm

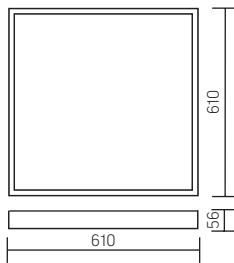

Lamp Size: 610×610×56 mm  
 Package size of the lamp:  
 615×615×66 mm  
 PF ≥0,95



○ white

Article	Power	Light temperature	Luminous flux
V1-A0-20070-01HGD-40036TW	36W	3000K - 5000K	3000-3500 lm
V1-A0-20070-01HGD-40050TW	36W	3000K - 5000K	3000-3500 lm

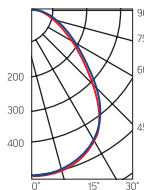

**NEW MODEL**

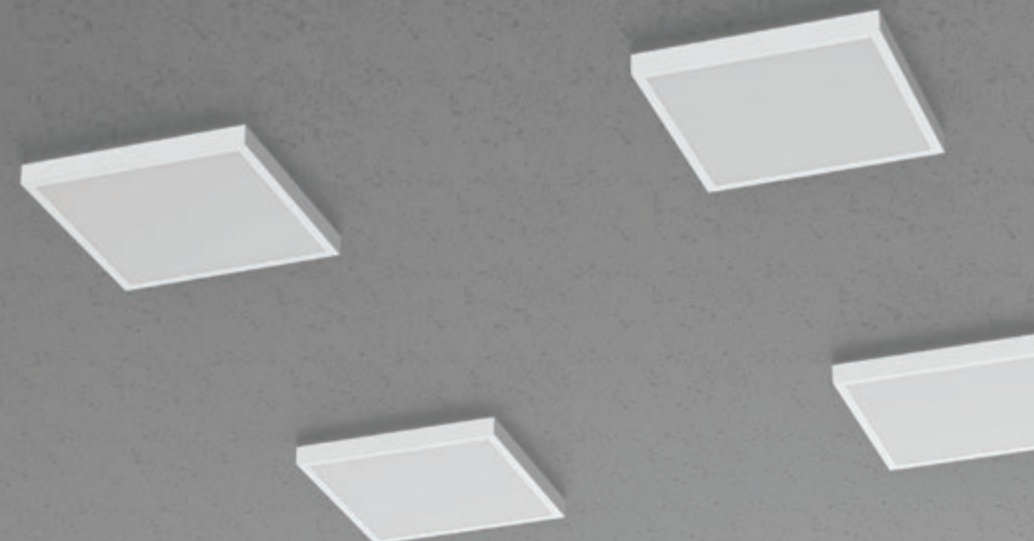

**Installation:**

The lamp is installed on a flat horizontal or vertical surface.

**Case Material:**

All-metal housing made of sheet steel with white powder coating

**Diffuser:**

Complete with opal diffuser

**Specifications:**

Index of color transmission Ra > 82

Temperature range from + 1 ° C to + 40 ° C

AC176-264V

Network frequency 50Hz +/- 10%

LED life 50,000 hours

3 year warranty

Luminous flux Kn <1%



## Series A recessed luminaires with uniform illumination

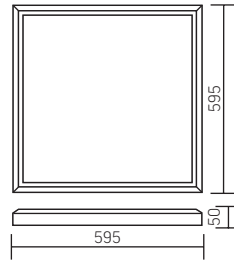

Lamp Size: 595x595x50mm  
 Package size of the lamp:  
 627x614x62mm  
 PF ≥0,95



○ white

Article	Power	Light temperature	Luminous flux*
V1-A0-00070-01HG0-4003630	36W	3000K	3800lm
V1-A0-00070-01HG0-4003640	36W	4000K	4000lm

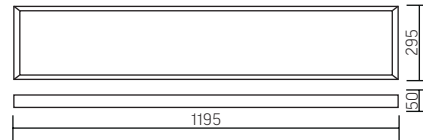
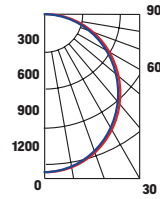

Lamp Size: 1195x295x50mm  
 Package size of the lamp:  
 1232x305x62mm  
 PF ≥0,95



○ white

Article	Power	Light temperature	Luminous flux*
V1-A0-00350-01HG0-4003630	36W	3000K	3400lm
V1-A0-00350-01HG0-4003640	36W	4000K	3600lm

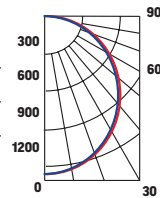

NEW  
MODEL

### Installation:

Built into Armstrong suspended ceilings

### Material:

All-metal housing made of sheet steel with white powder coating

### Diffuser:

Complete with opal diffuser

### Specifications:

Index of color transmission Ra > 82

Temperature range from + 1° to + 40 ° C

AC176-264V

Network frequency 50Hz +/- 10%

LED life 50,000 hours

3 year warranty

Luminous flux Kn ≤ 1%



# A400

1495x295x50 mm

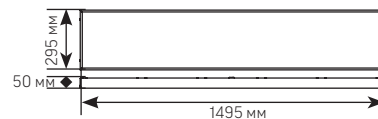

Lamp Size: 1495x295x50 mm  
 Package size of the lamp:  
 1500x300x60 mm  
 PF ≥0,95



○ white

Article	Power	Light temperature	Luminous flux*
V1-A0-00400-01000-2004040	40W	4000K	5 000 lm
V1-A0-00400-01000-2008040	80W	4000K	10 000 lm

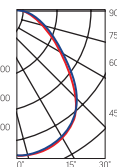

Diffuser (optional)



Article	Type	Diffuser size
V2-A0-PR00-00.2.0400.25	Prism standard	1490x290 mm
V2-A0-OP00-03.2.0400.15	Opal	1490x290 mm
V2-A0-PS00-00.2.0400.20	Pin spot	1490x290 mm
V2-A0-CI00-00.2.0400.20	Crushed ice	1490x290 mm
V2-A0-MP00-02.2.0400.20	Microprism	1490x290 mm

NEW MODEL



### Installation:

Surface mounted  
 Embedded installation in suspended ceiling systems

### Body:

All-metal housing made of sheet steel

### Specifications:

Index of color transmission Ra > 82  
 Temperature range from + 1 ° C to + 40 ° C  
 AC220-240V  
 Network frequency 50Hz +/- 10%  
 LED life 50,000 hours  
 3 year warranty  
 Luminous flux <1%



NEW  
MODEL



## A420

1495x100x50 mm

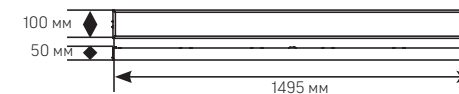

Lamp Size:1495x100x50 mm  
Package size of the lamp:  
1515x109x66 mm  
PF ≥0,95



○ white

Article	Power	Light temperature	Luminous flux*
V1-A0-00461-01000-4004040	40W	4000K	4300 lm
V1-A0-00461-01000-4008040	80W	4000K	8600 lm

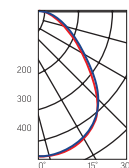

Article	Type	Diffuser size
V2-A0-PR00-00.2.0110.25	Prism standard	1490x95 mm
V2-A0-OP00-03.2.0110.15	Opal	1490x95 mm
V2-A0-PS00-00.2.0110.20	Pin spot	1490x95 mm
V2-A0-CI00-00.2.0110.20	Crushed ice	1490x95 mm
V2-A0-MP00-02.2.0110.20	Microprism	1490x95 mm

Diffuser (optional)

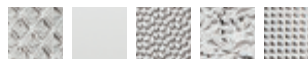

### Installation:

Surface mounted  
Embedded installation in suspended ceiling systems

### Case:

All-metal housing made of sheet steel

### Specifications:

Index of color transmission Ra > 82  
Temperature range from + 1 ° C to + 40 ° C  
AC220-240V  
Network frequency 50Hz +/- 10%  
LED life 50,000 hours  
3 year warranty  
Luminous flux <1%



# A450

1495x140x50 mm

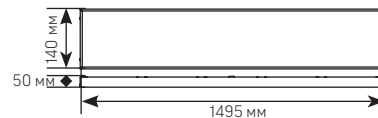

Lamp Size: 1495x140x50 mm  
 Package size of the lamp:  
 1577x155x62 mm  
 PF ≥0,95



○ white

Article	Power	Light temperature	Luminous flux*
V1-A0-00462-01000-4004040	40W	4000K	4 500 lm
V1-A0-00462-01000-4008040	80W	4000K	10 000 lm

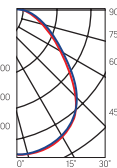

Diffuser (optional)



Article	Type	Diffuser size
V2-A0-PR00-00.2.0111.25	Prism standard	1490x135 mm
V2-A0-OP00-03.2.0111.15	Opal	1490x135 mm
V2-A0-PS00-00.2.0111.20	Pin spot	1490x135 mm
V2-A0-CI00-00.2.0111.20	Crushed ice	1490x135 mm
V2-A0-MP00-02.2.0111.20	Microprism	1490x135 mm

NEW MODEL



### Installation:

Surface mounted  
 Embedded installation in suspended ceiling systems

### Case:

All-metal housing made of sheet steel

### Specifications:

Index of color transmission Ra > 82  
 Temperature range from + 1 ° C to + 40 ° C  
 AC220-240V  
 Network frequency 50Hz +/- 10%  
 LED life 50,000 hours  
 3 year warranty  
 Luminous flux Kn <1%



NEW  
MODEL



## A470

1495x180x50 mm

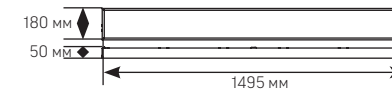

Lamp Size: 1495x180x50 mm  
 Package size of the lamp:  
 1500x190x60 mm  
 PF ≥0,95



○ white

Article	Power	Light temperature	Luminous flux*
V1-A0-00463-01000-4004040	40W	4000K	5 100 lm
V1-A0-00463-01000-4008040	80W	4000K	10 600 lm

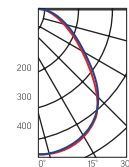

Article	Type	Diffuser size
V2-A0-PR00-00.2.0112.25	Prism standard	1490x175 mm
V2-A0-OP00-03.2.0112.15	Opal	1490x175 mm
V2-A0-PS00-00.2.0112.20	Pin spot	1490x175 mm
V2-A0-CI00-00.2.0112.20	Crushed ice	1490x175 mm
V2-A0-MP00-02.2.0112.20	Microprism	1490x175 mm

Diffuser (optional)



### Installation:

Surface mounted  
 Embedded installation in suspended ceiling systems

### Case:

All-metal housing made of sheet steel

### Specifications:

Index of color transmission Ra > 82  
 Temperature range from +1 °C to +40 °C  
 AC220-240V  
 Network frequency 50Hz +/- 10%  
 LED life 50,000 hours  
 3 year warranty  
 Luminous flux Kn <1%







# A070

595×595×50mm

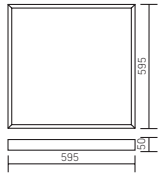

Package size of the lamp:  
627×614×62mm  
PF ≥ 0,95



○ white



Article	Power	Light temperature	Luminous flux*
V1-A0-00070-01000-XX02730	27W	3000K	3400 lm
V1-A0-00070-01000-XX02740	27W	4000K	3500 lm
V1-A0-00070-01000-XX02750	27W	5000K	3500 lm
V1-A0-00070-01000-XX02765	27W	6500K	3600 lm
V1-A0-00070-01000-XX03630	36W	3000K	4400 lm
V1-A0-00070-01000-XX03640	36W	4000K	4600 lm
V1-A0-00070-01000-XX03650	36W	5000K	4600 lm
V1-A0-00070-01000-XX03665	36W	6500K	4700 lm
V1-A0-00070-01000-XX05430	54W	3000K	6400 lm
V1-A0-00070-01000-XX05440	54W	4000K	6600 lm
V1-A0-00070-01000-XX05450	54W	5000K	6600 lm
V1-A0-00070-01000-XX05465	54W	6500K	6800 lm

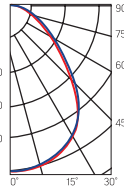

XX = 20 – lamp with degree of protection IP20  
XX = 40 – lamp with degree of protection IP40

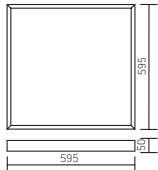

## Autonomous emergency lamp permanent action

Emergency power supply unit, battery for 1 hour of autonomous operation, charge indicator, "Test" button in the set (see description on page 266)

**Conformity:**  
GOST IEC 60598-2-22-2012 \*Luminaries. Part 2-22. Private requirements. Luminaries for emergency lighting \*SP 52. 13330. 2011\* Natural and artificial lighting \*(updated edition of SNIP 23.05-95)

Article	Power	Light temperature	Luminous flux*
V1-A0-00070-01A00-XX02730	27W	3000K	3400 lm
V1-A0-00070-01A00-XX02740	27W	4000K	3500 lm
V1-A0-00070-01A00-XX02750	27W	5000K	3500 lm
V1-A0-00070-01A00-XX02765	27W	6500K	3600 lm
V1-A0-00070-01A00-XX03630	36W	3000K	4400 lm
V1-A0-00070-01A00-XX03640	36W	4000K	4600 lm
V1-A0-00070-01A00-XX03650	36W	5000K	4600 lm
V1-A0-00070-01A00-XX03665	36W	6500K	4700 lm
V1-A0-00070-01A00-XX05430	54W	3000K	6400 lm
V1-A0-00070-01A00-XX05440	54W	4000K	6600 lm
V1-A0-00070-01A00-XX05450	54W	5000K	6600 lm
V1-A0-00070-01A00-XX05465	54W	6500K	6800 lm

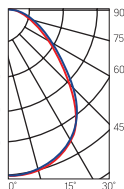

XX = 20 – lamp with degree of protection IP20  
XX = 40 – lamp with degree of protection IP40



Diffuser (optional)  
Pack size of diffuser (2 pcs.):  
610×610×16mm

Article	Type	Diffuser size
V2-A0-PR00-00.2.0007.25	Prism standard	588×588mm
V2-A0-OP00-03.2.0007.15	Opal	588×588mm
V2-A0-PS00-00.2.0007.20	Pin spot	588×588mm
V2-A0-CI00-00.2.0007.20	Crushed ice	588×588mm
V2-A0-MP00-02.2.0007.20	Microprism	588×588mm

\* Luminous Flux Set excluding the diffuser

### Installation:

Embedded in Armstrong suspended ceilings or mounted on a flat surface.

### Case:

All-metal housing made of sheet steel with white powder coating

### Specifications:

- Index of color transmission Ra > 80
- Temperature range from + 1 °C to + 40 °C
- AC176-264V
- Network frequency 50Hz ± 10%
- LED life 50,000 hours
- 3 year warranty
- Luminous flux Kn ≤ 1%



## A070/S

595×595×50mm

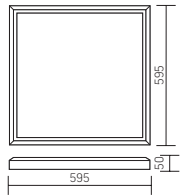

Package size of the lamp:  
627×614×62mm  
PF ≥ 0,95



Article	Power	Light temperature	Luminous flux*
V1-A0-00070-20000-XX03630	36W	3000K	4400 lm
V1-A0-00070-20000-XX03640	36W	4000K	4600 lm
V1-A0-00070-20000-XX03650	36W	5000K	4600 lm
V1-A0-00070-20000-XX03665	36W	6500K	4700 lm
V1-A0-00070-20000-XX05430	54W	3000K	6400 lm
V1-A0-00070-20000-XX05440	54W	4000K	6600 lm
V1-A0-00070-20000-XX05450	54W	5000K	6600 lm
V1-A0-00070-20000-XX05465	54W	6500K	6800 lm

XX = 20 – lamp with degree of protection IP20  
XX = 40 – lamp with degree of protection IP40

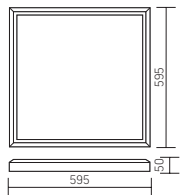
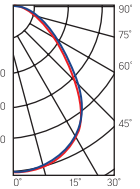

### **A** Autonomous emergency lamp permanent action

Emergency power supply unit, battery for 1 hour of autonomous operation, charge indicator, "Test" button in the set (see description on page 266)

**Conformity:**  
GOST IEC 60598-2-22-2012 "Luminaires. Part 2-22. Private requirements. Luminaires for emergency lighting "SP 52. 13330. 2011" Natural and artificial lighting "(updated edition of SNiP 23.05-95)

Article	Power	Light temperature	Luminous flux*
V1-A0-00070-20A00-XX03630	36W	3000K	4400 lm
V1-A0-00070-20A00-XX03640	36W	4000K	4600 lm
V1-A0-00070-20A00-XX03650	36W	5000K	4600 lm
V1-A0-00070-20A00-XX03665	36W	6500K	4700 lm
V1-A0-00070-20A00-XX05430	54W	3000K	6400 lm
V1-A0-00070-20A00-XX05440	54W	4000K	6600 lm
V1-A0-00070-20A00-XX05450	54W	5000K	6600 lm
V1-A0-00070-20A00-XX05465	54W	6500K	6800 lm

XX = 20 – lamp with degree of protection IP20  
XX = 40 – lamp with degree of protection IP40

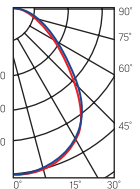

Diffuser (optional)  
Pack size of diffuser (2 pcs.):  
610×610×16mm

Article	Type	Diffuser size
V2-R0-PR00-00.2.0033.25	Prism standard	580×580mm
V2-R0-OP00-03.2.0033.15	Opal	580×580mm
V2-R0-PS00-00.2.0033.20	Pin spot	580×580mm
V2-R0-CI00-00.2.0033.20	Crushed ice	580×580mm
V2-R0-MP00-02.2.0033.20	Microprism	580×580mm

\* Luminous Flux Set excluding the diffuser

### Installation:

Mounted on a flat surface.

### Case:

All-metal housing made of sheet steel with white powder coating

### Specifications:

Index of color transmission Ra > 80

Temperature range from + 1 °C to + 40 °C

AC176-264V

Network frequency 50Hz ± 10%

LED life 50,000 hours

3 year warranty

Luminous flux Kn ≤ 1%





## A270

1195×180×50mm

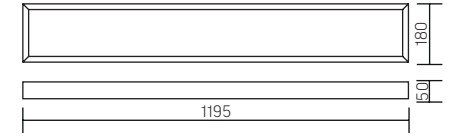

Package size of the lamp:  
1232×199×62mm  
PF ≥ 0,95



Article	Power	Light temperature	Luminous flux*
V1-A0-00270-01000-XX03630	36W	3000K	4100 lm
V1-A0-00270-01000-XX03640	36W	4000K	4300 lm
V1-A0-00270-01000-XX03650	36W	5000K	4300 lm
V1-A0-00270-01000-XX03665	36W	6500K	4300 lm
V1-A0-00270-01000-XX05430	54W	3000K	6000 lm
V1-A0-00270-01000-XX05440	54W	4000K	6100 lm
V1-A0-00270-01000-XX05450	54W	5000K	6100 lm
V1-A0-00270-01000-XX05465	54W	6500K	6200 lm

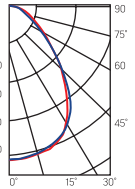

XX = 20 – lamp with degree of protection IP20  
XX = 40 – lamp with degree of protection IP40

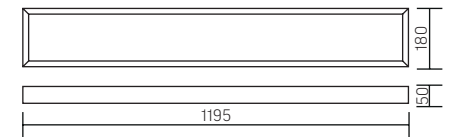

## Autonomous emergency lamp permanent action

Emergency power supply unit, battery for 1 hour of autonomous operation, charge indicator, "Test" button in the set (see description on page 266)

**Conformity:**  
GOST IEC 60598-2-22-2012 \*Luminaries. Part 2-22. Private requirements.  
Luminaries for emergency lighting "SP 52. 13330. 2011" Natural and artificial lighting (updated edition of SNiP 23.05-95)

Article	Power	Light temperature	Luminous flux*
V1-A0-00270-01A00-XX03630	36W	3000K	4100 lm
V1-A0-00270-01A00-XX03640	36W	4000K	4300 lm
V1-A0-00270-01A00-XX03650	36W	5000K	4300 lm
V1-A0-00270-01A00-XX03665	36W	6500K	4300 lm
V1-A0-00270-01A00-XX05430	54W	3000K	6000 lm
V1-A0-00270-01A00-XX05440	54W	4000K	6100 lm
V1-A0-00270-01A00-XX05450	54W	5000K	6100 lm
V1-A0-00270-01A00-XX05465	54W	6500K	6200 lm

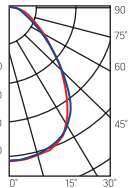

XX = 20 – lamp with degree of protection IP20  
XX = 40 – lamp with degree of protection IP40

### Installation:

Embedded in Armstrong suspended ceilings, mounted on a flat surface or cable trays

### Case:

All-metal housing made of sheet steel with white powder coating

### Specifications:

Index of color transmission Ra > 80

Temperature range from +1 °C to +40 °C

AC176-264V

Network frequency 50Hz ± 10%

LED life 50,000 hours



**A270**  
1195×180×50mm

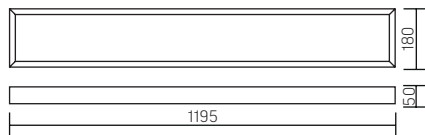

Application:  
Administrative premises in  
which more flexible lighting  
control is required

Article	Power	Light temperature	Luminous flux*
V1-A0-00270-01D01-XX03630	36W	3000K	4100 lm
V1-A0-00270-01D01-XX03640	36W	4000K	4300 lm
V1-A0-00270-01D01-XX03650	36W	5000K	4300 lm
V1-A0-00270-01D01-XX03665	36W	6500K	4300 lm

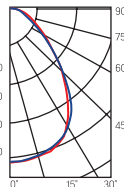

XX = 20 – lamp with degree of protection IP20  
XX = 40 – lamp with degree of protection IP40

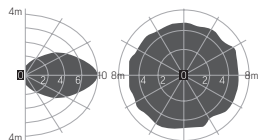
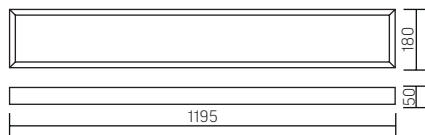

Application:  
Administrative premises where  
constant lighting is not required

Article	Power	Light temperature	Luminous flux*
V1-A0-00270-01S00-XX03630	36W	3000K	4100 lm
V1-A0-00270-01S00-XX03640	36W	4000K	4300 lm
V1-A0-00270-01S00-XX03650	36W	5000K	4300 lm
V1-A0-00270-01S00-XX03665	36W	6500K	4300 lm

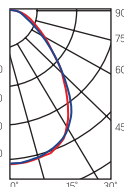

Diffuser (optional)  
Pack size of diffuser (2 pcs.):  
1205×190×18mm

Article	Type	Diffuser size
V2-A0-PR00-00.2.0017.25	Prism standard	1189×174mm
V2-A0-OP00-03.2.0017.15	Opal	1189×174mm
V2-A0-PS00-00.2.0017.20	Pin spot	1189×174mm
V2-A0-CI00-00.2.0017.20	Crushed ice	1189×174mm
V2-A0-MP00-02.2.0017.20	Microprism	1189×174mm

\* Luminous Flux Set excluding the diffuser



Shop "Avtomir" (Veliky Novgorod, Russia)





**A170**  
595×180×50mm

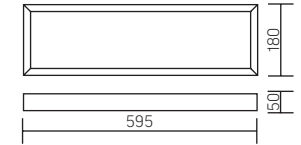

Package size of the lamp:  
600×180×66mm  
PF ≥ 0,95



○ white

Article	Power	Light temperature	Luminous flux*
V1-A0-00170-01000-XX01830	18W	3000K	2000 lm
V1-A0-00170-01000-XX01840	18W	4000K	2100 lm
V1-A0-00170-01000-XX01850	18W	5000K	2100 lm
V1-A0-00170-01000-XX01865	18W	6500K	2200 lm

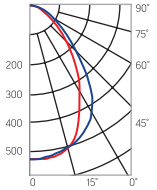

XX = 20 – lamp with degree of protection IP20  
XX = 40 – lamp with degree of protection IP40

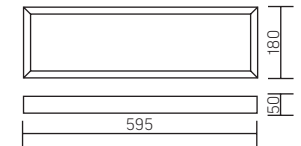

**A** **Autonomous emergency lamp permanent action**

Emergency power supply unit, battery for 1 hour of autonomous operation, charge indicator, "Test" button in the set (see description on page 266)

**Conformity:**  
GOST IEC 60598-2-22-2012 "Luminaries, Part 2-22. Private requirements. Luminaries for emergency lighting "SP 52.13330.2011" Natural and artificial lighting "(updated edition of SNiP 23.05-95)

Article	Power	Light temperature	Luminous flux*
V1-A0-00170-01A00-XX01830	18W	3000K	2000 lm
V1-A0-00170-01A00-XX01840	18W	4000K	2100 lm
V1-A0-00170-01A00-XX01850	18W	5000K	2100 lm
V1-A0-00170-01A00-XX01865	18W	6500K	2200 lm

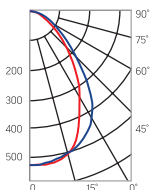

XX = 20 – lamp with degree of protection IP20  
XX = 40 – lamp with degree of protection IP40



Diffuser (optional)  
Pack size of diffuser (2 pcs.):  
1205×190×18mm

Article	Type	Diffuser type
V2-A0-PR00-00.2.0008.25	Prism standard	590×174mm
V2-A0-OP00-03.2.0008.15	Opal	590×174mm
V2-A0-PS00-00.2.0008.20	Pin spot	590×174mm
V2-A0-CI00-00.2.0008.20	Crushed ice	590×174mm
V2-A0-MP00-02.2.0008.20	Microprism	590×174mm

\* Luminous Flux Set excluding the diffuser

**Installation:**

Embedded in Armstrong suspended ceilings, mounted on a flat surface or cable trays

**Case:**

All-metal housing made of sheet steel with white powder coating

**Specifications:**

- Index of color transmission Ra > 80
- Temperature range from + 1 ° C to + 40 ° C
- AC176-264V
- Network frequency 50Hz ± 10%
- LED life 50,000 hours
- 3 year warranty
- Luminous flux Kn ≤ 1%



## A220

1195×100×50mm

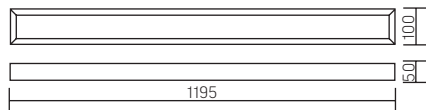

Package size of the lamp:

1200×100×66mm

PF ≥ 0,95



○ white

Article	Power	Light temperature	Luminous flux*
V1-A0-00220-20000-XX01830	18W	3000K	1800 lm
V1-A0-00220-20000-XX01840	18W	4000K	2000 lm
V1-A0-00220-20000-XX01850	18W	5000K	2000 lm
V1-A0-00220-20000-XX01865	18W	6500K	2000 lm
V1-A0-00220-20000-XX03630	36W	3000K	3700 lm
V1-A0-00220-20000-XX03640	36W	4000K	3900 lm
V1-A0-00220-20000-XX03650	36W	5000K	3900 lm
V1-A0-00220-20000-XX03665	36W	6500K	3900 lm

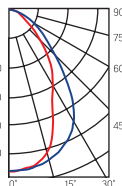

XX = 20 – lamp with degree of protection IP20

XX = 40 – lamp with degree of protection IP40

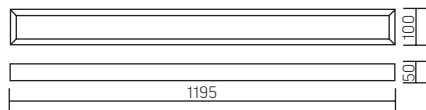

### Autonomous emergency lamp permanent action

Emergency power supply unit, battery for 1 hour of autonomous operation, charge indicator, "Test" button in the set (see description on page 266)

#### Conformity:

GOST IEC 60598-2-22-2012 "Luminaires. Part 2-22. Private requirements. Luminaires for emergency lighting "SP 52. 13330. 2011" Natural and artificial lighting " (updated edition of SNiP 23.05-95)

Article	Power	Light temperature	Luminous flux*
V1-A0-00220-20A00-XX01830	18W	3000K	1800 lm
V1-A0-00220-20A00-XX01840	18W	4000K	2000 lm
V1-A0-00220-20A00-XX01850	18W	5000K	2000 lm
V1-A0-00220-20A00-XX01865	18W	6500K	2000 lm
V1-A0-00220-20A00-XX03630	36W	3000K	3700 lm
V1-A0-00220-20A00-XX03640	36W	4000K	3900 lm
V1-A0-00220-20A00-XX03650	36W	5000K	3900 lm
V1-A0-00220-20A00-XX03665	36W	6500K	3900 lm

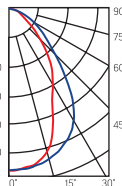

XX = 20 – lamp with degree of protection IP20

XX = 40 – lamp with degree of protection IP40

Article	Type	Diffuser size
V2-A0-PR00-00.2.0016.25	Prism standard	1189×96mm
V2-A0-0P00-03.2.0016.15	Opal	1189×96mm
V2-A0-PS00-00.2.0016.20	Pin spot	1189×96mm
V2-A0-CI00-00.2.0016.20	Crushed ice	1189×96mm
V2-A0-MP00-02.2.0016.20	Microprism	1189×96mm

\* Luminous Flux Set excluding the diffuser



Diffuser (optional)

Pack size of diffuser (2 pcs):  
1205×190×18mm

### Installation:

Embedded in Armstrong suspended ceilings, mounted on a flat surface or cable trays

### Case:

All-metal housing made of sheet steel with white powder coating

### Specifications:

Index of color transmission Ra > 80

Temperature range from +1 °C to +40 °C

AC176-264V

Network frequency 50Hz ± 10%

LED life 50,000 hours

3 year warranty

Luminous flux Kn ≤ 1%





**Installation:**

Embedded in Armstrong suspended ceilings, mounted on a flat surface or cable trays

**Case:**

All-metal housing made of sheet steel with white powder coating

**Specifications:**

Index of color transmission Ra > 80

Temperature range from + 1 °C to + 40 °C

AC176-264V

Network frequency 50Hz ± 10%

LED life 50,000 hours

3 year warranty

Luminous flux Kn ≤ 1%



**A370**

595×295×50mm

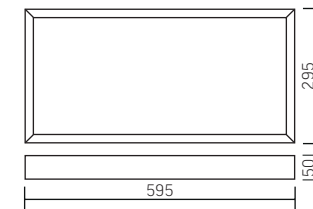

Package size of the lamp:  
600×300×66mm  
PF ≥ 0,95



○ white

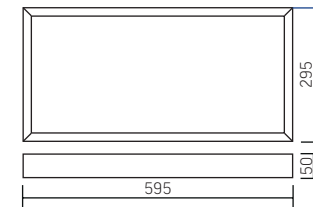

Article	Power	Light temperature	Luminous flux*
V1-A0-00370-01000-XX01830	18W	3000K	1900 lm
V1-A0-00370-01000-XX01840	18W	4000K	2000 lm
V1-A0-00370-01000-XX01850	18W	5000K	2000 lm
V1-A0-00370-01000-XX01865	18W	6500K	2000 lm
V1-A0-00370-01000-XX02730	27W	3000K	3100 lm
V1-A0-00370-01000-XX02740	27W	4000K	3200 lm
V1-A0-00370-01000-XX02750	27W	5000K	3200 lm
V1-A0-00370-01000-XX02765	27W	6500K	3200 lm

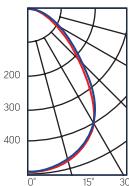

XX = 20 – lamp with degree of protection IP20  
XX = 40 – lamp with degree of protection IP40

**A Autonomous emergency lamp permanent action**

Emergency power supply unit, battery for 1 hour of autonomous operation, charge indicator, "Test" button in the set (see description on page 266)

**Conformity:**

GOST IEC 60598-2-22-2012 "Luminaries. Part 2-22. Private requirements. Luminaries for emergency lighting "SP 52. 13330. 2011" Natural and artificial lighting "(updated edition of SNIP 23.05-95)

Article	Power	Light temperature	Luminous flux*
V1-A0-00370-01A00-XX01830	18W	3000K	1900 lm
V1-A0-00370-01A00-XX01840	18W	4000K	2000 lm
V1-A0-00370-01A00-XX01850	18W	5000K	2000 lm
V1-A0-00370-01A00-XX01865	18W	6500K	2000 lm
V1-A0-00370-01A00-XX02730	27W	3000K	3100 lm
V1-A0-00370-01A00-XX02740	27W	4000K	3200 lm
V1-A0-00370-01A00-XX02750	27W	5000K	3200 lm
V1-A0-00370-01A00-XX02765	27W	6500K	3200 lm

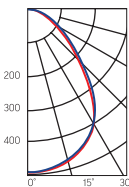

XX = 20 – lamp with degree of protection IP20  
XX = 40 – lamp with degree of protection IP40



Diffuser (optional)

Pack size of diffuser (2 pcs.):  
1205×305×18mm

Article	Type	Diffuser size
V2-A0-PR00-00.2.0010.25	Prism standard	590×290mm
V2-A0-OP00-03.2.0010.15	Opal	590×290mm
V2-A0-PS00-00.2.0010.20	Pin spot	590×290mm
V2-A0-CI00-00.2.0010.20	Crushed ice	590×290mm
V2-A0-MP00-02.2.0010.20	Microprism	590×290mm

\* Luminous Flux Set excluding the diffuser





**A350**  
1195×295×50mm

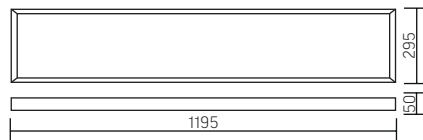

Package size of the lamp:  
1232×305×62mm  
PF ≥ 0,95



Article	Power	Light temperature	Luminous flux*
V1-A0-00350-01000-XX03630	36W	3000K	4000 lm
V1-A0-00350-01000-XX03640	36W	4000K	4200 lm
V1-A0-00350-01000-XX03650	36W	5000K	4200 lm
V1-A0-00350-01000-XX03665	36W	6500K	4400 lm
V1-A0-00350-01000-XX05430	54W	3000K	6500 lm
V1-A0-00350-01000-XX05440	54W	4000K	6700 lm
V1-A0-00350-01000-XX05450	54W	5000K	6700 lm
V1-A0-00350-01000-XX05465	54W	6500K	6700 lm

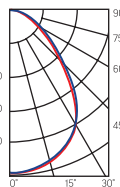

XX = 20 – lamp with degree of protection IP20  
XX = 40 – lamp with degree of protection IP40

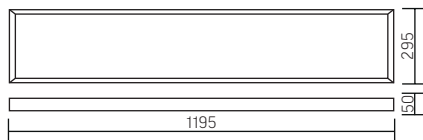

**A** **Autonomous emergency lamp permanent action**

Emergency power supply unit, battery for 1 hour of autonomous operation, charge indicator, "Test" button in the set (see description on page 266)

**Conformity:**  
GOST IEC 60598-2-22:2012 "Luminaries. Part 2-22. Private requirements. Luminaries for emergency lighting "SP 52. 13330. 2011" Natural and artificial lighting " (updated edition of SNiP 23.05-95)

Article	Power	Light temperature	Luminous flux*
V1-A0-00350-01A00-XX03630	36W	3000K	4000 lm
V1-A0-00350-01A00-XX03640	36W	4000K	4200 lm
V1-A0-00350-01A00-XX03650	36W	5000K	4200 lm
V1-A0-00350-01A00-XX03665	36W	6500K	4400 lm
V1-A0-00350-01A00-XX05430	54W	3000K	6500 lm
V1-A0-00350-01A00-XX05440	54W	4000K	6700 lm
V1-A0-00350-01A00-XX05450	54W	5000K	6700 lm
V1-A0-00350-01A00-XX05465	54W	6500K	6700 lm

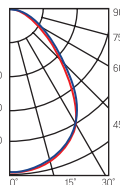

XX = 20 – lamp with degree of protection IP20  
XX = 40 – lamp with degree of protection IP40

Article	Type	Diffuser size
V2-A0-PR00-00.2.0019.25	Prism standard	1190×290mm
V2-A0-OP00-03.2.0019.15	Opal	1190×290mm
V2-A0-PS00-00.2.0019.20	Pin spot	1190×290mm
V2-A0-CI00-00.2.0019.20	Crushed ice	1190×290mm
V2-A0-MP00-02.2.0019.20	Microprism	1190×290mm

\* Luminous Flux Set excluding the diffuser



Diffuser (optional)  
Pack size of diffuser (2 pcs):  
1205×305×18mm

**Installation:**

Embedded in Armstrong suspended ceilings, mounted on a flat surface or cable trays

**Case:**

All-metal housing made of sheet steel with white powder coating

**Specifications:**

Index of color transmission Ra > 80  
Temperature range from + 1 ° C to + 40 ° C  
AC176-264V  
Network frequency 50Hz ± 10%  
LED life 50,000 hours  
3 year warranty  
Luminous flux Kn ≤ 1%





## G070

595×595×67mm

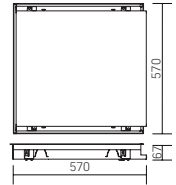

Package size of the lamp:  
627×614×62mm  
Mounting size: 575×575 mm  
PF ≥ 0,95



Article	Power	Light temperature	Luminous flux*
V1-A0-00009-80000-2003630	36W	3000K	4400 lm
V1-A0-00009-80000-2003640	36W	4000K	4600 lm
V1-A0-00009-80000-2003650	36W	5000K	4600 lm
V1-A0-00009-80000-2003665	36W	6500K	4700 lm
V1-A0-00009-80000-2005430	54W	3000K	6400 lm
V1-A0-00009-80000-2005440	54W	4000K	6600 lm
V1-A0-00009-80000-2005450	54W	5000K	6600 lm
V1-A0-00009-80000-2005465	54W	6500K	6800 lm

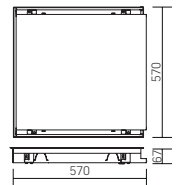
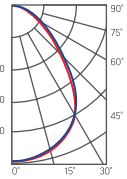

### Autonomous emergency lamp permanent action

Emergency power supply unit, battery for 1 hour of autonomous operation, charge indicator, "Test" button in the set (see description on page 266)

**Conformity:**  
GOST IEC 60598-2-22-2012 \*Luminaries. Part 2-22.  
Private requirements. Luminaries for emergency lighting "SP 52. 13330. 2011" Natural and artificial lighting "(updated edition of SNiP 23.05-95)

Article	Power	Light temperature	Luminous flux*
V1-A0-00009-80A00-2003630	36W	3000K	4400 lm
V1-A0-00009-80A00-2003640	36W	4000K	4600 lm
V1-A0-00009-80A00-2003650	36W	5000K	4600 lm
V1-A0-00009-80A00-2003665	36W	6500K	4700 lm
V1-A0-00009-80A00-2005430	54W	3000K	6400 lm
V1-A0-00009-80A00-2005440	54W	4000K	6600 lm
V1-A0-00009-80A00-2005450	54W	5000K	6600 lm
V1-A0-00009-80A00-2005465	54W	6500K	6800 lm

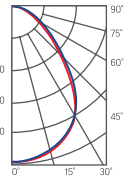

### Installation:

Embedded in plaster-board ceilings (8-15mm)  
Necessary mounting hole for mounting the lamp 575 × 575mm  
Mount included

### Case:

All-metal housing made of sheet steel with white powder coating

### Specifications:

Index of color transmission Ra > 80  
Temperature range from + 1 °C to + 40 °C  
AC176-264V  
Network frequency 50Hz ± 10%  
LED life 50,000 hours  
3 year warranty  
Luminous flux Kn ≤ 1%



Diffuser (optional)  
Pack size of diffuser (2 pcs.):  
606×606×18mm

Article	Type	Diffuser size
V2-A0-PR00-00.2.0001.25	Prism standard	558×558mm
V2-A0-OP00-03.2.0001.15	Opal	558×558mm
V2-A0-PS00-00.2.0001.20	Pin spot	558×558mm
V2-A0-CI00-00.2.0001.20	Crushed ice	558×558mm
V2-A0-MP00-02.2.0001.20	Microprism	558×558mm

\* Luminous Flux Set excluding the diffuser



## G270

1200x198x67mm

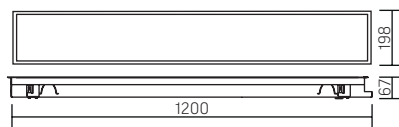

Package size of the lamp: 1232x199x69mm

Mounting size: 1180x180 mm

PF ≥ 0,95



○ white

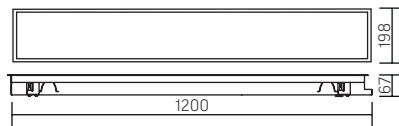

Article	Power	Light temperature	Luminous flux*
V1-A0-00032-80000-2003630	36W	3000K	4100 lm
V1-A0-00032-80000-2003640	36W	4000K	4300 lm
V1-A0-00032-80000-2003650	36W	5000K	4300 lm
V1-A0-00032-80000-2003665	36W	6500K	4300 lm
V1-A0-00032-80000-2005430	54W	3000K	6000 lm
V1-A0-00032-80000-2005440	54W	4000K	6100 lm
V1-A0-00032-80000-2005450	54W	5000K	6100 lm
V1-A0-00032-80000-2005465	54W	6500K	6200 lm

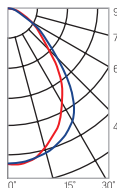

### **A** Autonomous emergency lamp permanent action

Emergency power supply unit, battery for 1 hour of autonomous operation, charge indicator, "Test" button in the set (see description on page 266)

**Conformity:**  
GOST IEC 60598-2-22:2012 "Luminaries. Part 2-22. Private requirements. Luminaries for emergency lighting "SP 52. 13330. 2011" Natural and artificial lighting "(updated edition of SNiP 23.05-95)

Article	Power	Light temperature	Luminous flux*
V1-A0-00032-80A00-2003630	36W	3000K	4100 lm
V1-A0-00032-80A00-2003640	36W	4000K	4300 lm
V1-A0-00032-80A00-2003650	36W	5000K	4300 lm
V1-A0-00032-80A00-2003665	36W	6500K	4300 lm
V1-A0-00032-80A00-2005430	54W	3000K	6000 lm
V1-A0-00032-80A00-2005440	54W	4000K	6100 lm
V1-A0-00032-80A00-2005450	54W	5000K	6100 lm
V1-A0-00032-80A00-2005465	54W	6500K	6200 lm

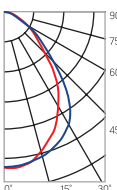

Diffuser (optional)  
Pack size of diffuser (2 pcs.):  
1205x190x18mm

Article	Type	Diffuser size
V2-A0-PR00-00.2.0021.25	Prism standard	1163x160mm
V2-A0-OP00-03.2.0021.15	Opal	1163x160mm
V2-A0-PS00-00.2.0021.20	Pin spot	1163x160mm
V2-A0-CI00-00.2.0021.20	Crushed ice	1163x160mm
V2-A0-MP00-02.2.0021.20	Microprism	1163x160mm

\* Luminous Flux Set excluding the diffuser

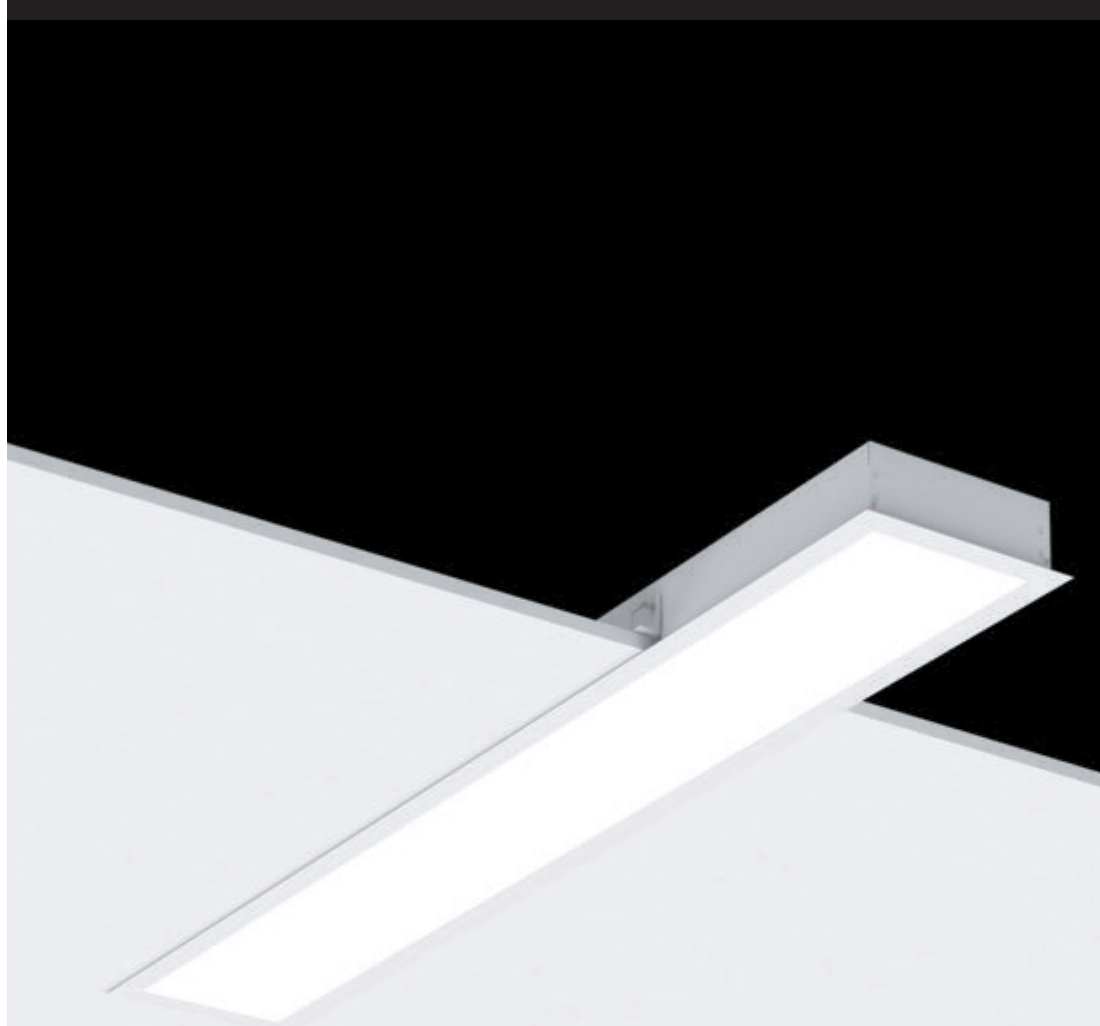

### Installation:

Fitted into plasterboard ceilings (8-15mm)  
Required mounting hole for lamp installation 1175 × 180mm  
Mount included

### Case:

All-metal housing made of sheet steel with white powder coating

### Specifications:

Index of color transmission Ra > 80  
Temperature range from + 1 ° C to + 40 ° C  
AC176-264V  
Network frequency 50Hz ± 10%  
LED life 50,000 hours  
3 year warranty  
Luminous flux Kn ≤ 1%



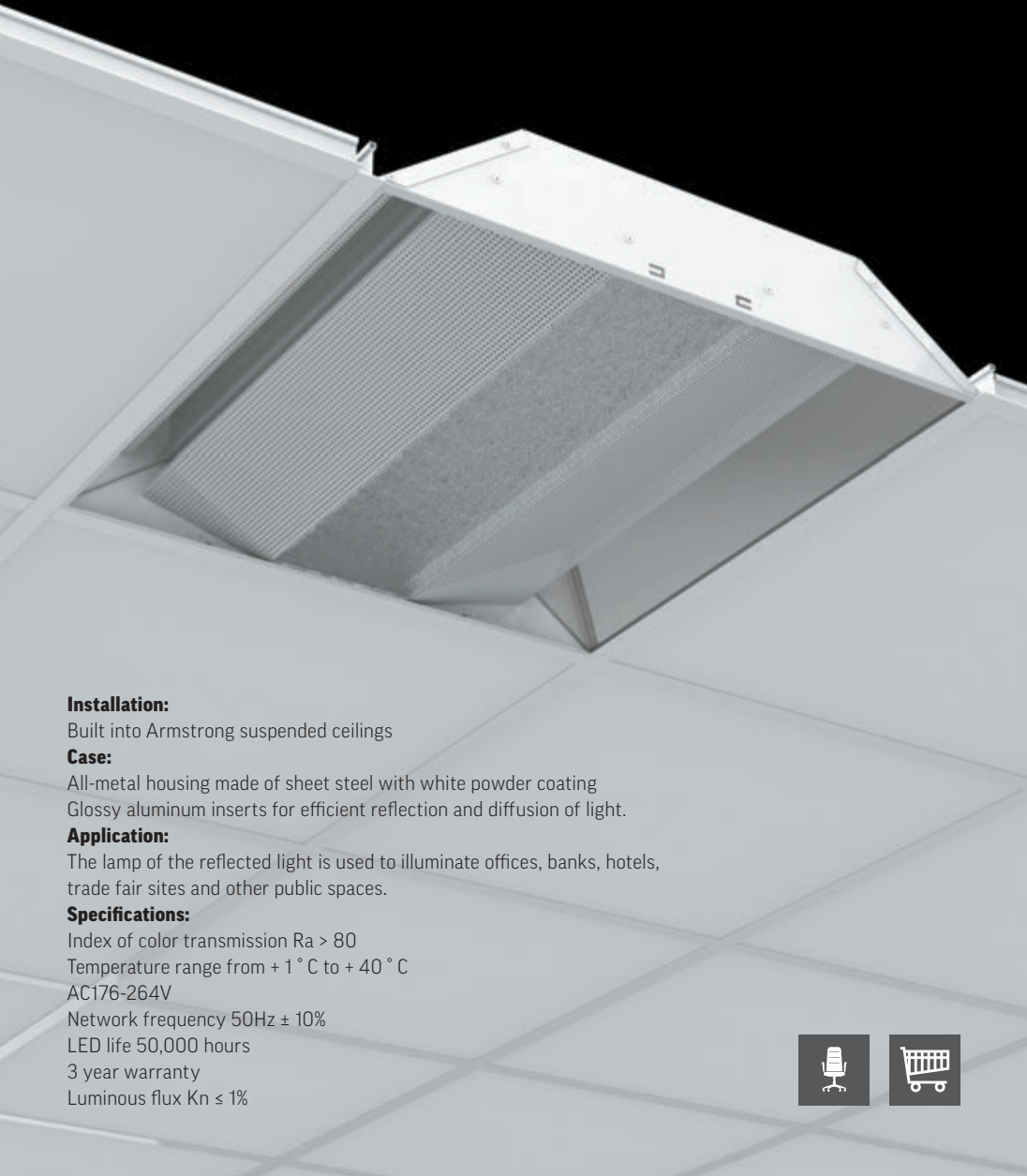

**Installation:**

Built into Armstrong suspended ceilings

**Case:**

All-metal housing made of sheet steel with white powder coating  
Glossy aluminum inserts for efficient reflection and diffusion of light.

**Application:**

The lamp of the reflected light is used to illuminate offices, banks, hotels, trade fair sites and other public spaces.

**Specifications:**

- Index of color transmission Ra > 80
- Temperature range from + 1 ° C to + 40 ° C
- AC176-264V
- Network frequency 50Hz ± 10%
- LED life 50,000 hours
- 3 year warranty
- Luminous flux Kn ≤ 1%



**A070/OT**  
595×595×100mm

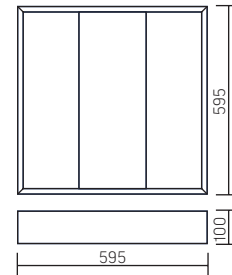

Package size of the lamp:  
635×614×102mm  
PF ≥ 0,95



Article	Power	Light temperature	Luminous flux
V1-A0-00025-10000-2003640	36W	4000K	2200lm
V1-A0-00025-10000-2003665	36W	6500K	2400lm

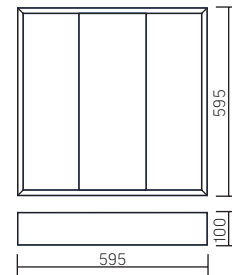
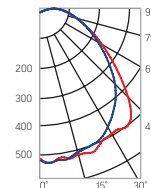

**A** Autonomous emergency lamp permanent action

Emergency power supply unit, battery for 1 hour of autonomous operation, charge indicator, "Test" button in the set (see description on page 266)

Article	Power	Light temperature	Luminous flux
V1-A0-00025-10A00-2003640	36W	4000K	2200lm
V1-A0-00025-10A00-2003665	36W	6500K	2400lm

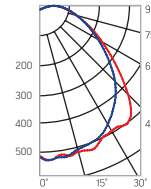

**Conformity:**  
GOST IEC 60598-2-22:2012 "Luminaries. Part 2-22. Private requirements. Luminaries for emergency lighting "SP 52. 13330. 2011" Natural and artificial lighting "(updated edition of SNIP 23.05-95)



## A300

1195×595×50mm

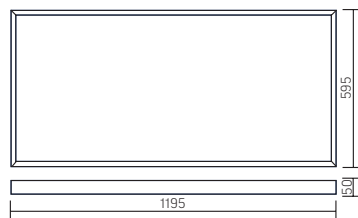

Package size of the lamp:

1232×615×60mm

PF ≥ 0,95



○ white

Article	Power	Light temperature	Luminous flux*
V1-A0-00300-01000-XX07230	72W	3000K	8600 lm
V1-A0-00300-01000-XX07240	72W	4000K	9000 lm
V1-A0-00300-01000-XX07250	72W	5000K	9000 lm
V1-A0-00300-01000-XX07265	72W	6500K	9400 lm

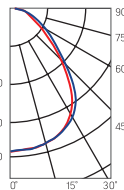

XX = 20 – lamp with degree of protection IP20

XX = 40 – lamp with degree of protection IP40

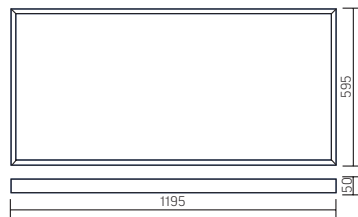

### Autonomous emergency lamp permanent action

Emergency power supply unit, battery for 1 hour of autonomous operation, charge indicator, "Test" button in the set (see description on page 266)

#### Conformity:

GOST IEC 60598-2-22-2012 "Luminaries. Part 2-22. Private requirements. Luminaries for emergency lighting "SP 52. 13330. 2011" Natural and artificial lighting "(updated edition of SNiP 23.05-95)

Article	Power	Light temperature	Luminous flux*
V1-A0-00300-01A00-XX07230	72W	3000K	8600 lm
V1-A0-00300-01A00-XX07240	72W	4000K	9000 lm
V1-A0-00300-01A00-XX07250	72W	5000K	9000 lm
V1-A0-00300-01A00-XX07265	72W	6500K	9400 lm

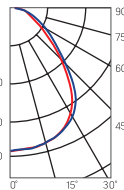

XX = 20 – lamp with degree of protection IP20

XX = 40 – lamp with degree of protection IP40



Diffuser (optional)

Pack size of diffuser (2 pcs.): 1220×610×16mm

Article	Type	Diffuser size
V2-A0-PR00-00.2.0018.25	Prism standard	1189×588mm
V2-A0-OP00-02.2.0018.20	Opal	1189×588mm
V2-A0-PS00-00.2.0018.20	Pin spot	1189×588mm
V2-A0-CI00-00.2.0018.20	Crushed ice	1189×588mm
V2-A0-MP00-02.2.0018.20	Microprism	1189×588mm

\* Luminous Flux Set excluding the diffuser

#### Installation:

Embedded in Armstrong suspended ceilings or mounted on a flat surface.

#### Case:

All-metal housing made of sheet steel with white powder coating

#### Specifications:

Index of color transmission Ra > 80

Temperature range from + 1 °C to + 40 °C

AC176-264V

Network frequency 50Hz ± 10%

LED life 50,000 hours

3 year warranty

Luminous flux Kn ≤ 1%





## AL220

1170×100×50mm, for slatted ceilings

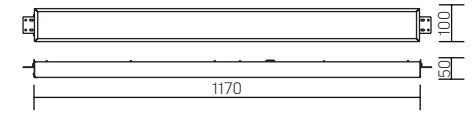

Package size of the lamp:  
1200×100×66mm  
PF ≥ 0,95



○ white

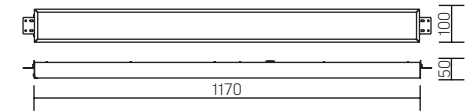

Article	Power	Light temperature	Luminous flux
V1-A1-00363-10000-2001830	18W	3000K	1800 lm
V1-A1-00363-10000-2001840	18W	4000K	2000 lm
V1-A1-00363-10000-2001850	18W	5000K	2000 lm
V1-A1-00363-10000-2001865	18W	6500K	2000 lm
V1-A1-00363-10000-2003630	36W	3000K	3700 lm
V1-A1-00363-10000-2003640	36W	4000K	3900 lm
V1-A1-00363-10000-2003650	36W	5000K	3900 lm
V1-A1-00363-10000-2003665	36W	6500K	3900 lm

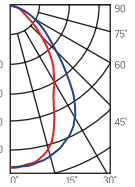

## Autonomous emergency lamp permanent action

Emergency power supply unit, battery for 1 hour of autonomous operation, charge indicator, "Test" button in the set (see description on page 266)

**Conformity:**  
GOST IEC 60598-2-22-2012 "Luminaries. Part 2-22. Private requirements. Luminaries for emergency lighting "SP 52.13330.2011" Natural and artificial lighting "(updated edition of SNiP 23.05-95)

Article	Power	Light temperature	Luminous flux
V1-A1-00363-10A00-2001830	18W	3000K	1800 lm
V1-A1-00363-10A00-2001840	18W	4000K	2000 lm
V1-A1-00363-10A00-2001850	18W	5000K	2000 lm
V1-A1-00363-10A00-2001865	18W	6500K	2000 lm
V1-A1-00363-10A00-2003630	36W	3000K	3700 lm
V1-A1-00363-10A00-2003640	36W	4000K	3900 lm
V1-A1-00363-10A00-2003650	36W	5000K	3900 lm
V1-A1-00363-10A00-2003665	36W	6500K	3900 lm

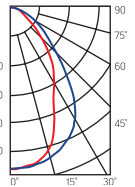

### Installation:

Fitted in slatted ceilings with slats of Italian and German design

### Case:

All-metal housing made of sheet steel with white powder coating

### Specifications:

Index of color transmission Ra > 80

Temperature range from + 1 ° C to + 40 ° C

AC176-264V

Network frequency 50Hz ± 10%

LED life 50,000 hours

3 year warranty

Luminous flux Kn ≤ 1%



Diffuser (optional)

Pack size of diffuser (2 pcs.):

1205×190×18mm

Article	Type	Diffuser size
V2-A0-PR00-00.2.0016.25	Prism standard	1189×96mm
V2-A0-0P00-03.2.0016.15	Opal	1189×96mm
V2-A0-PS00-00.2.0016.20	Pin spot	1189×96mm
V2-A0-C100-00.2.0016.20	Crushed ice	1189×96mm
V2-A0-MP00-02.2.0016.20	Microprism	1189×96mm

\* Luminous Flux Set excluding the diffuser



## AL270

1325×308×70mm, for slatted ceilings

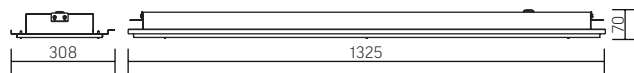

Package size of the lamp:

1355×327×80mm

PF ≥ 0,95



○ white

Article	Power	Light temperature	Luminous flux
V1-C1-00083-10000-5403630	36W	3000K	3000 lm
V1-C1-00083-10000-5403640	36W	4000K	3200 lm
V1-C1-00083-10000-5403650	36W	5000K	3200 lm
V1-C1-00083-10000-5403665	36W	6500K	3200 lm

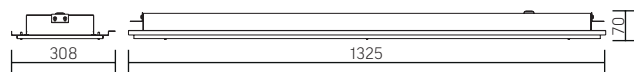
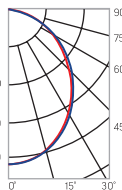

### **A** Autonomous emergency lamp permanent action

Emergency power supply unit, battery for 1 hour of autonomous operation, charge indicator, "Test" button in the set (see description on page 266)

#### Conformity:

GOST IEC 60598-2-22-2012 "Luminaires. Part 2-22. Private requirements. Luminaires for emergency lighting "SP 52. 13330. 2011" Natural and artificial lighting "(updated edition of SNIP 23.05-95)

Article	Power	Light temperature	Luminous flux
V1-C1-00083-10A00-5403630	36W	3000K	3000 lm
V1-C1-00083-10A00-5403640	36W	4000K	3200 lm
V1-C1-00083-10A00-5403650	36W	5000K	3200 lm
V1-C1-00083-10A00-5403665	36W	6500K	3200 lm

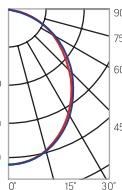

#### Installation:

Fitted in slatted ceilings with slats of Italian and German design of a closed type

#### Case:

All-metal housing made of sheet steel with white powder coating

To ensure the degree of protection IP54 around the perimeter of the body is fixed silicone seal

#### Application of luminaire with degree of protection IP54:

Medical institutions, restaurants, food industry premises, canteens, laboratories, toilets, rooms with high humidity

#### Diffuser:

Complete with opal polycarbonate diffuser

#### Specifications:

Index of color transmission Ra > 80

Temperature range from -20 °C to + 40 °C

AC176-264V

Network frequency 50Hz ± 10%

LED life 50,000 hours

3 year warranty

Luminous flux Kn ≤ 1%





**AL170**  
705×308×70mm, for slatted ceilings

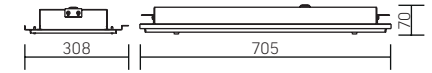

Package size of the lamp:  
742×333×81mm  
PF ≥ 0,95



Article	Power	Light temperature	Luminous flux
V1-C1-00105-10000-5401830	18W	3000K	1600 lm
V1-C1-00105-10000-5401840	18W	4000K	1700 lm
V1-C1-00105-10000-5401850	18W	5000K	1700 lm
V1-C1-00105-10000-5401865	18W	6500K	1800 lm

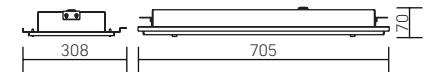
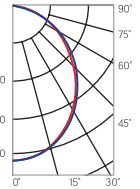

**Installation:**

Fitted in slatted ceilings with slats of Italian and German design of a closed type

**Case:**

All-metal housing made of sheet steel with white powder coating  
To ensure the degree of protection IP54 around the perimeter of the body is fixed silicone seal

Application of luminaire with degree of protection IP54:

Medical facilities, restaurants, food processing facilities, canteens, laboratories, toilets, rooms with high humidity

**Diffuser:**

Complete with opal polycarbonate diffuser

**Specifications:**

Index of color transmission Ra > 80

Temperature range from -20 °C to + 40 °C

AC176-264V

Network frequency 50Hz ± 10%

LED life 50,000 hours

3 year warranty

Luminous flux ≤ 1%

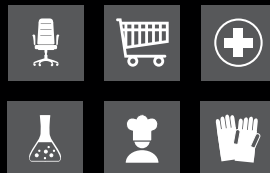

**Autonomous emergency lamp permanent action**

Emergency power supply unit, battery for 1 hour of autonomous operation, charge indicator, "Test" button in the set (see description on page 266)

**Conformity:**

GOST IEC 60598-2-22-2012 "Luminaires. Part 2-22. Private requirements. Luminaires for emergency lighting "SP 52. 13330. 2011" Natural and artificial lighting "(updated edition of SNiP 23.05-95)

Article	Power	Light temperature	Luminous flux
V1-C1-00105-10A00-5401830	18W	3000K	1600 lm
V1-C1-00105-10A00-5401840	18W	4000K	1700 lm
V1-C1-00105-10A00-5401850	18W	5000K	1700 lm
V1-C1-00105-10A00-5401865	18W	6500K	1800 lm

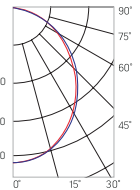





**SPECIAL**

**SOLUTIONS FOR SPECIAL CEILINGS**

## Types of Armstrong® suspended ceiling systems Armstrong®

Suspended ceiling systems are classified according to 2 main criteria: the type of suspension system and the type of edge (ceiling tile). The table provides information on the compatibility of types of ceiling edges and Armstrong™ suspended ceiling systems.

Edge type	Type of suspension system					
	Silhouette*	Prelude 15*	Prelude 24XL*	Prelude 24TLX*	Gema Grid*	V-Clip*
Board			■	■		
Vector			■	■		
Microlook		■				
Microlook BE	■	■				
Tegular			■	■		
Clip-In					■	
V-Clip						■

This catalog presents the performance of VARTON lamps for all listed combinations.

EDGE TYPE OF BOARD® (A070/A220/A270/A350...)

Edge – Board®  
Ceiling systems – Prelude 24®



SERIES VECTOR®

594×594×58mm  
Edge – Vector®  
Ceiling systems – Prelude 24®



SERIES FOR MICROLOOK®/ MICROLOOK BE®

584×584×58mm  
Edge – MicroLook®/MicroLook BE® Ceiling systems –  
Prelude 15®/Silhouette®

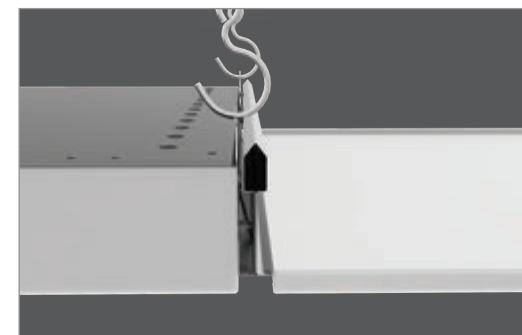

SERIES FOR TEGULAR®

574×587×58mm  
Edge – Tegular®  
Ceiling systems – Prelude 24®

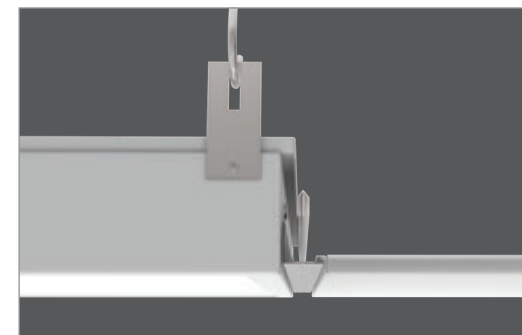

SERIES FOR CLIP-IN®

600×600×100mm  
Edge – Clip-In®  
Ceiling systems – Q-Clip®, Q-Clip F®, R-Clip®, R-Clip F®,  
S-Clip®, S-Clip F®

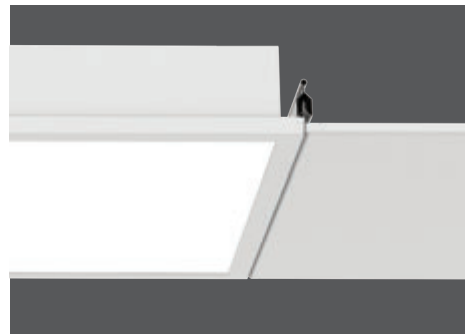

**SPECIAL**

**Varton for SL2®**  
1218×308×68mm

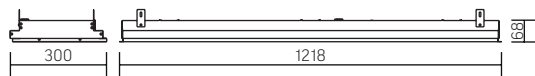

Package size of the lamp:  
1228×308×66mm  
PF ≥ 0,95



○ white

Article	Power	Light temperature	Luminous flux
V1-A1-00352-10000-2003630	36W	3000K	3000 lm
V1-A1-00352-10000-2003640	36W	4000K	3200 lm
V1-A1-00352-10000-2003650	36W	5000K	3200 lm

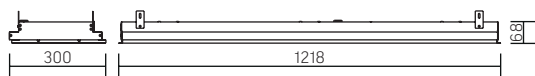
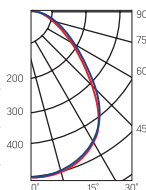

**A Autonomous emergency lamp permanent action**

Emergency power supply unit, battery for 1 hour of autonomous operation, charge indicator, "Test" button in the set (see description on page 266)

**Conformity:**  
GOST IEC 60598-2-22-2012 "Luminaries. Part 2-22. Private requirements. Luminaries for emergency lighting "SP 52. 13330. 2011" Natural and artificial lighting "(updated edition of SNIP 23.05-95)

Article	Power	Light temperature	Luminous flux
V1-A1-00352-10A00-2003630	36W	3000K	3000 lm
V1-A1-00352-10A00-2003640	36W	4000K	3200 lm
V1-A1-00352-10A00-2003650	36W	5000K	3200 lm

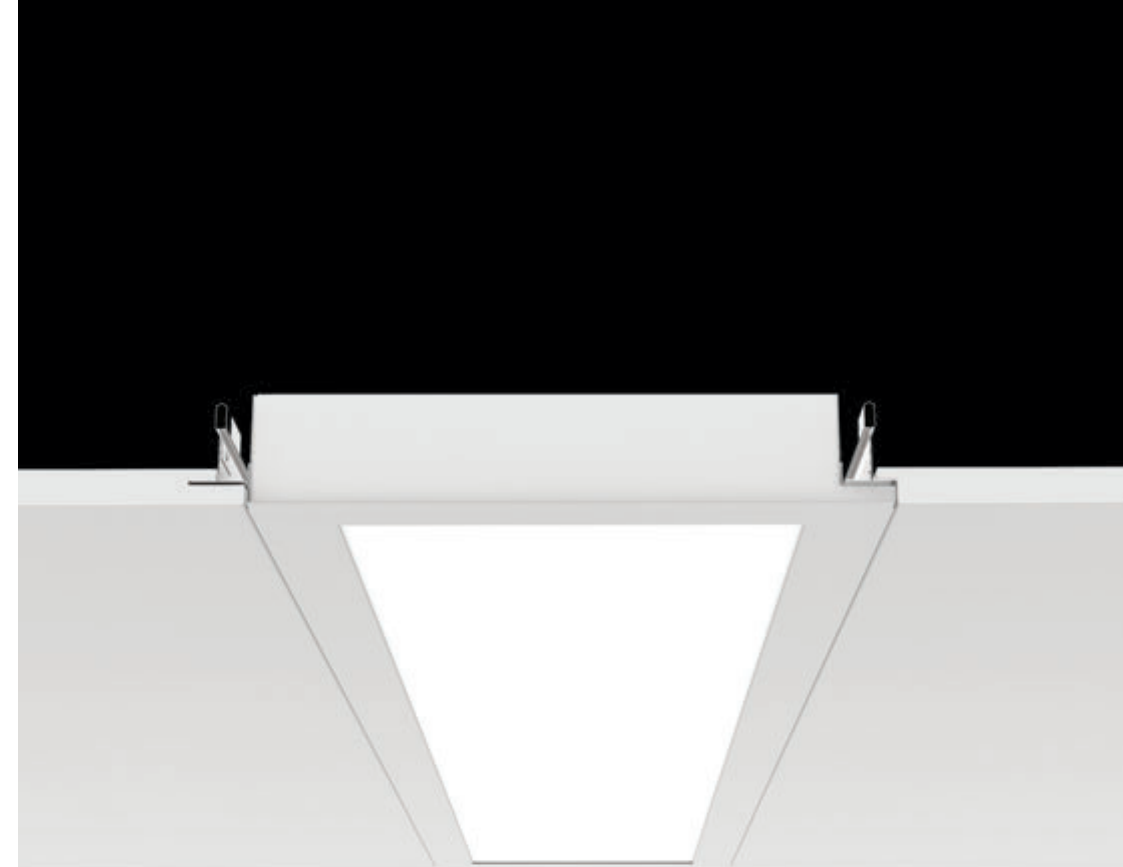
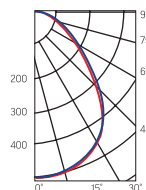

**Installation:**

Embedded in Armstrong® suspended ceiling systems  
The lamp is made in the same style with Vector® ceiling tiles

**Case:**

All-metal housing made of sheet steel with white powder coating

**Diffuser:**

Opal PMMA included

**Specifications:**

Index of color transmission Ra > 82

Temperature range from + 1 ° C to + 40 ° C

AC176-264V

Network frequency 50Hz ± 10%

LED life 50,000 hours

3 year warranty

Luminous flux Kn ≤ 1%



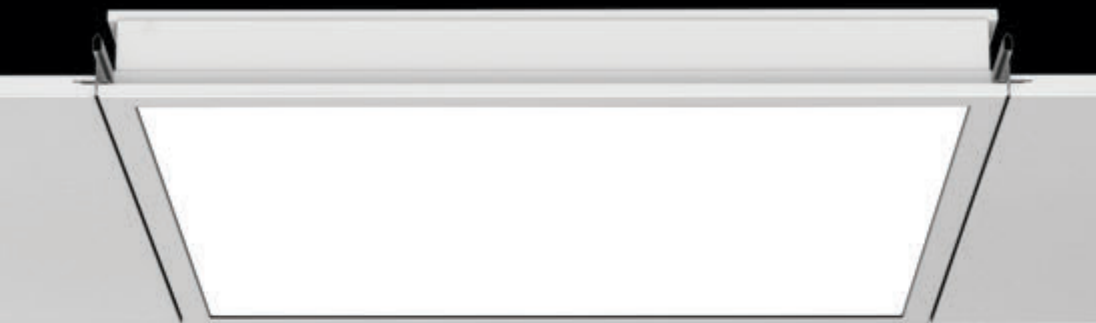

## Varton for Vector®

594×594×58mm

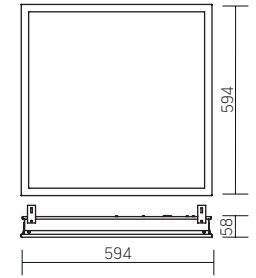

Package size of the lamp:  
627×614×62mm  
PF ≥ 0,95



Article	Power	Light temperature	Luminous flux
V1-A1-00072-10HGO-2003630	36W	3000K	3800 lm
V1-A1-00072-10HGO-2003640	36W	4000K	4000 lm
<b>DALI</b> V1-A1-00072-10HGD-2003630	36W	3000K	3800 lm
<b>DALI</b> V1-A1-00072-10HGD-2003640	36W	4000K	4000 lm

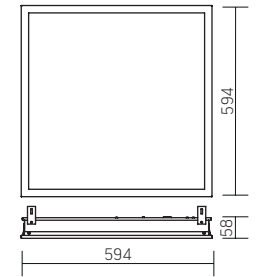
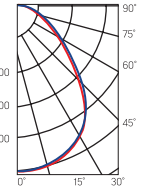

### **A** Autonomous emergency lamp permanent action

Emergency power supply unit, battery for 1 hour of autonomous operation, charge indicator, "Test" button in the set (see description on page 266)

Article	Power	Light temperature	Luminous flux
V1-A1-00072-10HGA-2003630	36W	3000K	3800 lm
V1-A1-00072-10HGA-2003640	36W	4000K	4000 lm

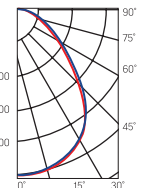

**Conformity:**  
GOST IEC 60598-2-22-2012 "Luminaries. Part 2-22. Private requirements. Luminaries for emergency lighting "SP 52. 13330. 2011" Natural and artificial lighting "(updated edition of SNiP 23.05-95)

### Installation:

Embedded in Armstrong® suspended ceiling systems  
The lamp is made in the same style with Vector® ceiling tiles

### Case:

All-metal housing made of sheet steel with white powder coating

### Diffuser:

Opal PMMA included

### Specifications:

Index of color transmission Ra > 82

Temperature range from + 1 °C to + 40 °C

AC176-264V

Network frequency 50Hz ± 10%

LED life 50,000 hours

3 year warranty

Luminous flux Kn ≤ 1%



**SPECIAL**

**Varton for Vector®**  
1194×294×57mm

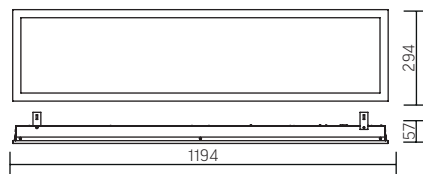

Package size of the lamp:  
1288×308×66mm  
PF ≥ 0,95



○ white

**DALI**  
**DALI**

Article	Power	Light temperature	Luminous flux
V1-A1-00352-10HGO-2003630	36W	3000K	3600 lm
V1-A1-00352-10HGO-2003640	36W	4000K	3800 lm
V1-A1-00352-10HGD-2003630	36W	3000K	3600 lm
V1-A1-00352-10HGD-2003640	36W	4000K	3800 lm

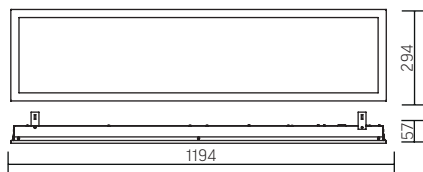
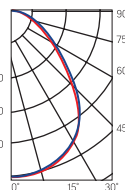

**A** **Autonomous emergency lamp permanent action**

Emergency power supply unit, battery for 1 hour of autonomous operation, charge indicator, "Test" button in the set (see description on page 266)

**Conformity:**  
GOST IEC 60598-2-22-2012 "Luminaries. Part 2-22.  
Private requirements. Luminaries for emergency lighting "SP 52.13330.2011" Natural and artificial lighting "(updated edition of SNiP 23.05-95)

Article	Power	Light temperature	Luminous flux
V1-A1-00352-10HGA-2003630	36W	3000K	3600 lm
V1-A1-00352-10HGA-2003640	36W	4000K	3800 lm

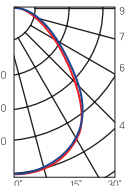

**Installation:**  
Embedded in Armstrong® suspended ceiling systems  
The lamp is made in the same style with Vector® ceiling tiles

**Case:**  
All-metal housing made of sheet steel with white powder coating

**Diffuser:**  
Opal PMMA included

**Specifications:**  
Index of color transmission Ra > 82  
Temperature range from + 1 ° C to + 40 ° C  
AC176-264V  
Network frequency 50Hz ± 10%  
LED life 50,000 hours  
3 year warranty  
Luminous flux Kn ≤ 1%



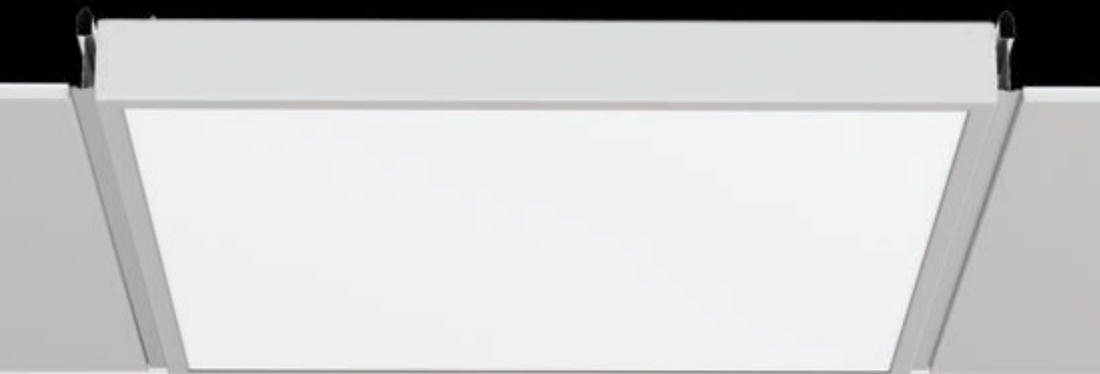

## Varton for MicroLook®

584×584×58mm

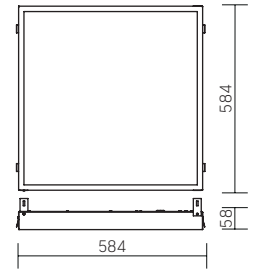

Package size of the lamp:  
627×614×62mm  
PF > 0,95



Article	Power	Light temperature	Luminous flux
V1-A1-00014-10HGO-2003630	36W	3000K	3800 lm
V1-A1-00014-10HGO-2003640	36W	4000K	4000 lm
V1-A1-00014-10HGD-2003630	36W	3000K	3800 lm
V1-A1-00014-10HGD-2003640	36W	4000K	4000 lm

DALI  
DALI

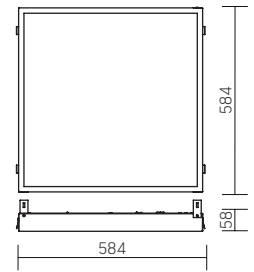
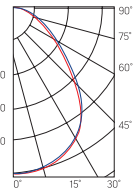

### **A** Autonomous emergency lamp permanent action

Emergency power supply unit, battery for 1 hour of autonomous operation, charge indicator, "Test" button in the set (see description on page 266)

Article	Power	Light temperature	Luminous flux
V1-A1-00014-10HGA-2003630	36W	3000K	3800 lm
V1-A1-00014-10HGA-2003640	36W	4000K	4000 lm

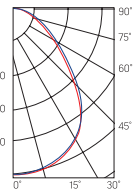

**Conformity:**  
GOST IEC 60598-2-22-2012 "Luminaries. Part 2-22.  
Private requirements. Luminaries for emergency lighting "SP 52.13330.2011" Natural and artificial lighting "(updated edition of SNIP 23.05-95)

### Installation:

Embedded in Armstrong® suspended ceiling systems, Prelude 15° and Silhouette®  
The lamp is made in the same style with ceiling plates MicroLook / MicroLook BE®

### Case:

All-metal housing made of sheet steel with white powder coating

### Diffuser:

Opal PMMA included

### Specifications:

Index of color transmission Ra > 82  
Temperature range from + 1 °C to + 40 °C  
AC176-264V  
Network frequency 50Hz ± 10%  
LED life 50,000 hours  
3 year warranty  
Luminous flux Kn ≤ 1%



SPECIAL

**Varton for MicroLook®**  
1184×284×56mm

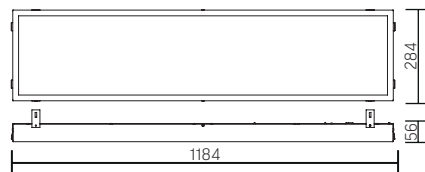

Package size of the lamp:  
1228×308×66mm  
PF ≥ 0,95



○ white

DALI

DALI

Article	Power	Light temperature	Luminous flux
V1-A1-00350-10HGO-2003630	36W	3000K	3600 lm
V1-A1-00350-10HGO-2003640	36W	4000K	3800 lm
V1-A1-00350-10HGD-2003630	36W	3000K	3600 lm
V1-A1-00350-10HGD-2003640	36W	4000K	3800 lm

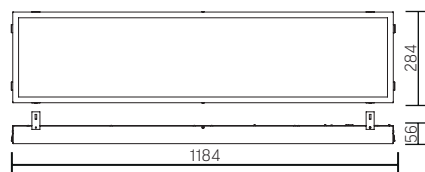
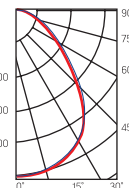

**A Autonomous emergency lamp permanent action**

Emergency power supply unit, battery for 1 hour of autonomous operation, charge indicator, "Test" button in the set (see description on page 266)

**Conformity:**  
GOST IEC 60598-2-22-2012 "Luminaries. Part 2-22.  
Private requirements. Luminaries for emergency lighting "SP 52.13330.2011" Natural and artificial lighting "(updated edition of SNIP 23.05-95)

Article	Power	Light temperature	Luminous flux
V1-A1-00350-10HGA-2003630	36W	3000K	3600 lm
V1-A1-00350-10HGA-2003640	36W	4000K	3800 lm

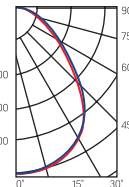

**Installation:**

Integrated into Armstrong®, Prelude 15° and Silhouette® suspended ceiling systems The lamp is made in the same style with ceiling plates MicroLook® / MicroLook BE®

**Case:**

All-metal housing made of sheet steel with white powder coating

**Diffuser:**

Opal PMMA included

**Specifications:**

Index of color transmission Ra > 82

Temperature range from + 1 ° C to + 40 ° C

AC176-264V

Network frequency 50Hz ± 10%

LED life 50,000 hours

3 year warranty

Luminous flux Kn ≤ 1%

**SPECIAL**



## Varton for MicroLook® 370

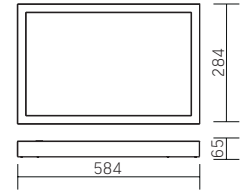

Lamp Size: 584x284x65 mm

Package size of the lamp:

635x314x67 mm

PF ≥0,95



○ white

Article

Power

Light  
tempera-  
ture

Luminous  
flux

V1-A1-00492-10HGO-2002530	25W	3000K	2000 lm
---------------------------	-----	-------	---------

V1-A1-00492-10HGO-2002540	25W	4000K	2000 lm
---------------------------	-----	-------	---------

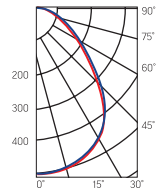

### Installation:

The luminaires are built into Armstrong® suspended ceiling systems and are made in the same style with MicroLook® ceiling strips.

### Case:

All-metal housing made of sheet steel

### Diffuser:

Opal PMMA included

### Specifications:

Index of color transmission Ra > 82

Temperature range from + 1 °C to + 40 °C

AC220-240V

Network frequency 50Hz +/- 10%

LED life 50,000 hours

3 year warranty

Luminous flux Kn <1%

SPECIAL



## Varton Clip-In®

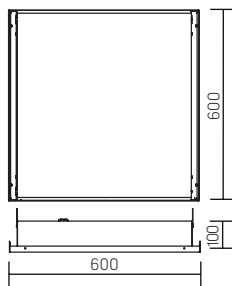

Package size of the lamp:  
627×614×110mm  
PF ≥ 0,95



Article	Power	Light temperature	Luminous flux
V1-A1-00027-10HG0-5403630	36W	3000K	3800 lm
V1-A1-00027-10HG0-5403640	36W	4000K	4000 lm

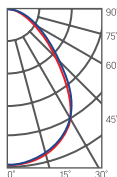

○ white

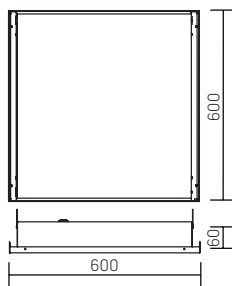

Package size of the lamp:  
627×614×62mm  
PF ≥ 0,95



Article	Power	Light temperature	Luminous flux
V1-A1-00027-10HG0-4003630	36W	3000K	3800 lm
V1-A1-00027-10HG0-4003640	36W	4000K	4000 lm

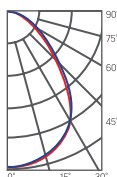

○ white

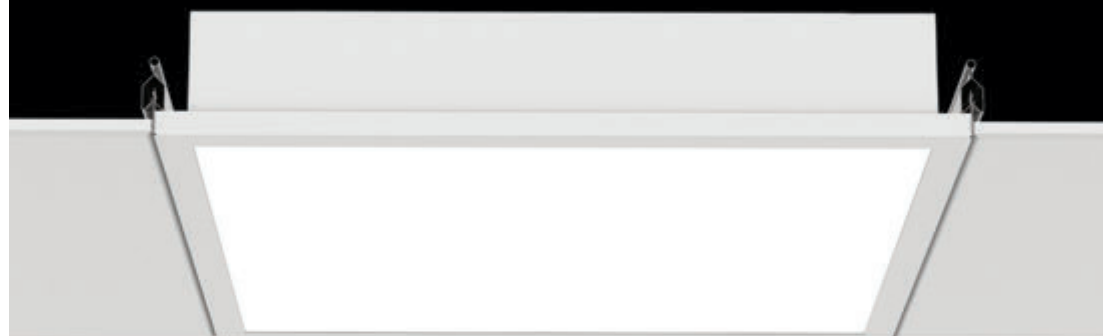

### Installation:

Embedded in Armstrong Gema Grid® suspended ceiling systems

### Case:

All-metal housing made of sheet steel with white powder coating  
To ensure the degree of protection IP54 around the perimeter of the body is fixed silicone seal

### Application of luminaire with degree of protection IP54:

Medical facilities, restaurants, premises food industry, canteens, laboratories, toilets, rooms with high humidity

### Diffuser:

IP54: Opal PC

IP40: Opal PMMA

### Specifications:

Index of color transmission Ra > 82

Temperature range from -20 °C to + 40 °C

AC176-264V

Network frequency 50Hz ± 10%

LED life 50,000 hours

3 year warranty

Luminous flux Kn ≤ 1%



## Varton Clip-In®

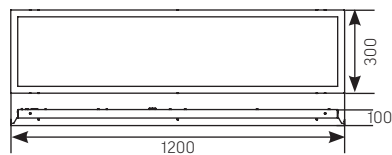

Lamp Size:  
1200×300×100mm  
Package size of the lamp:  
1228×305×66mm  
PF ≥ 0,95

Article	Power	Light temperature	Luminous flux
V1-A1-Y1010-10000-4003630	36W	3000K	3600 lm
V1-A1-Y1010-10000-4003640	36W	4000K	3800 lm

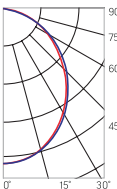

○ white

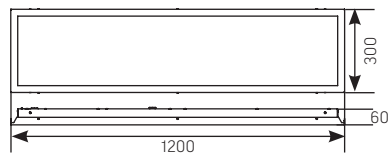

## DALI

Lamp Size:  
1200×300×60mm  
Package size of the lamp:  
1228×305×66mm  
PF ≥ 0,97

Article	Power	Light temperature	Luminous flux
V1-A1-Y1010-10D01-4003630	36W	3000K	3600 lm
V1-A1-Y1010-10D01-4003640	36W	4000K	3800 lm

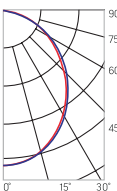

○ white

НОВАЯ  
МОДЕЛЬ

### Installation:

Embedded in Armstrong V-Clip® suspended ceiling systems

### Case:

All-metal housing made of sheet steel with white powder coating

To ensure the degree of protection IP54 around the perimeter of the body is fixed silicone seal

### Application of luminaire with degree of protection IP54:

Medical facilities, restaurants, food processing facilities, canteens, laboratories,

toilets, rooms with high humidity

### Diffuser:

Opal PMMA included

### Specifications:

Index of color transmission Ra > 82

Temperature range from -20 ° C to + 40 ° C for IP54

Temperature range from + 1 ° C to + 40 ° C for IP40

AC176-264V

Network frequency 50Hz ± 10%

LED life 50,000 hours

3 year warranty

Luminous flux Kn ≤ 1%



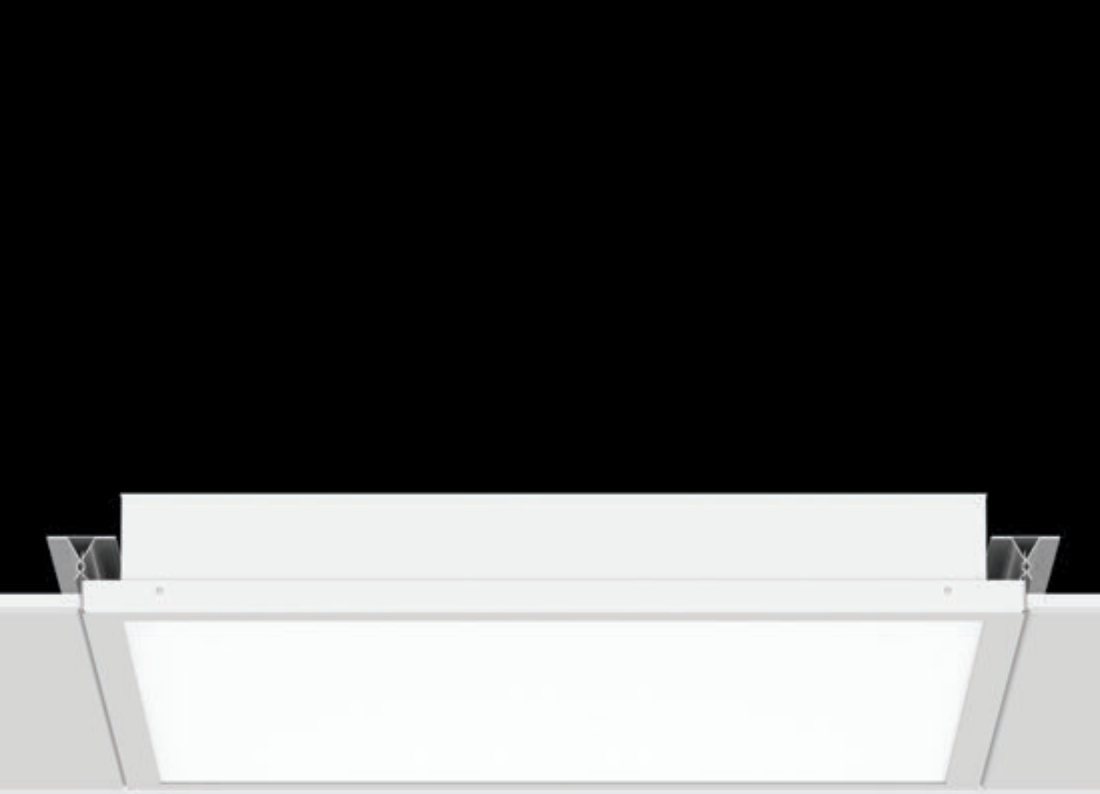

**Installation:**

Embedded in Armstrong V-Clip® suspended ceiling systems

**Case:**

All-metal housing made of sheet steel with white powder coating

To ensure the degree of protection IP54 around the perimeter of the body is fixed silicone seal

**Application of luminaire with degree of protection IP54:**

Medical institutions, restaurants, food industry premises, canteens, laboratories, toilets, rooms with high humidity

**Diffuser:**

IP54: Opal PC

IP40: Opal PMMA

**Specifications:**

Index of color transmission Ra > 82

Temperature range from -20 °C to + 40 °C

AC176-264V

Network frequency 50Hz ± 10%

LED life 50,000 hours

3 year warranty

Luminous flux Kn ≤ 1%

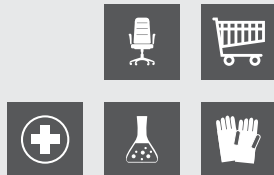

**Varton V-Clip®**

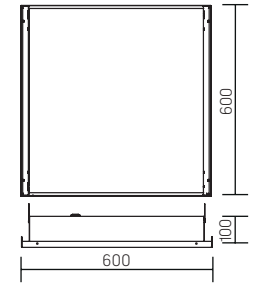

PF ≥ 0,95



○ white

Article	Power	Light temperature	Luminous flux
V1-A1-Y1070-10000-5403630	36W	3000K	3800 lm
V1-A1-Y1070-10000-5403640	36W	4000K	4000 lm

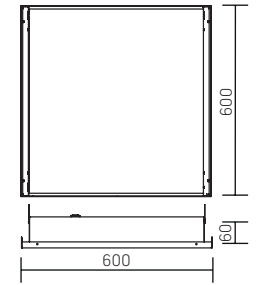
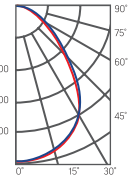

PF ≥ 0,95



○ white

Article	Power	Light temperature	Luminous flux
V1-A1-Y1070-10000-4003630	36W	3000K	3800 lm
V1-A1-Y1070-10000-4003640	36W	4000K	4000 lm

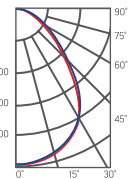

## Varton for Tegular®

574×587×64mm

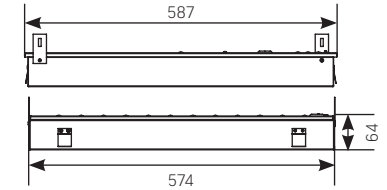

Package size of the lamp:  
627×614×62mm  
PF ≥ 0,95



○ white

Article	Power	Light temperature	Luminous flux
V1-A1-00070-10HGO-2003630	36W	3000K	3800 lm
V1-A1-00070-10HGO-2003640	36W	4000K	4000 lm
<b>DALI</b> V1-A1-00070-10HGD-2003630	36W	3000K	3800 lm
<b>DALI</b> V1-A1-00070-10HGD-2003640	36W	4000K	4000 lm

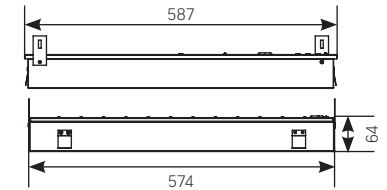
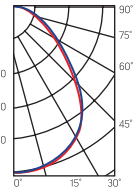

### **A** Autonomous emergency lamp permanent action

Emergency power supply unit, battery for 1 hour of autonomous operation, charge indicator, "Test" button in the set (see description on page 266)

Article	Power	Light temperature	Luminous flux
V1-A1-00070-10HGA-2003630	36W	3000K	3800 lm
V1-A1-00070-10HGA-2003640	36W	4000K	4000 lm

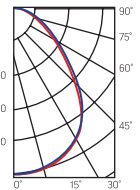

### Conformity:

GOST IEC 60598-2-22:2012 "Luminaries. Part 2-22.  
Private requirements. Luminaries for emergency lighting "SP 52. 13330. 2011" Natural and artificial lighting "(updated edition of SNiP 23.05-95)

### Installation:

Embedded in Armstrong® suspended ceiling systems  
The lamp is made in the same style with Tegular® ceiling tiles

### Case:

All-metal housing made of sheet steel with white powder coating

### Diffuser:

Opal PMMA included

### Specifications:

Index of color transmission Ra > 82

Temperature range from + 1 °C to + 40 °C

AC176-264V

Network frequency 50Hz ± 10%

LED life 50,000 hours

3 year warranty

Luminous flux Kn ≤ 1%



SPECIAL

## Varton for Finesse®

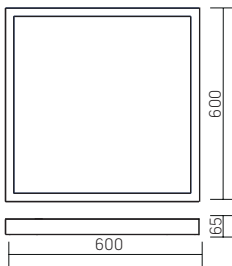

Lamp Size: 1200x600x65 mm  
 Package size of the lamp:  
 635x614x67 mm  
 PF ≥0,95



Article	Power	Light temperature	Luminous flux
V1-A1-00525-10HGO-4003630	36W	3000K	3600 lm
V1-A1-00525-10HGO-4003640	36W	4000K	3800 lm

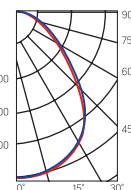

## Varton for Finesse®

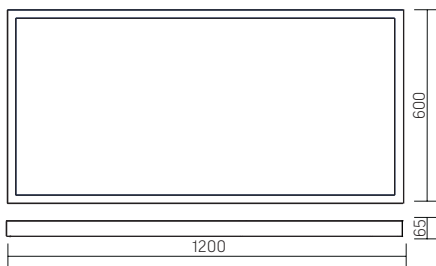

Lamp Size: 1200x600x65 mm  
 Package size of the lamp:  
 1228x606x66 mm  
 PF ≥0,95



Article	Power	Light temperature	Luminous flux
V1-A1-00526-10HGO-4005030	50W	3000K	4500 lm
V1-A1-00526-10HGO-4005040	50W	4000K	4700 lm

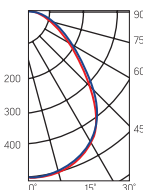

### Installation:

The luminaires are built into Armstrong® suspended ceiling systems and are made in the same style with Finesse® ceiling strips.

### Case:

All-metal housing made of sheet steel

### Diffuser:

Opal PMMA included

### Specifications:

Index of color transmission Ra > 82

Temperature range from + 1 ° C to + 40 ° C

AC220-240V

Network frequency 50Hz +/- 10%

LED life 50,000 hours

3 year warranty

Luminous flux Kn <1%

## Varton for Ecophon

595×588×50mm (ceiling type Gedina D)

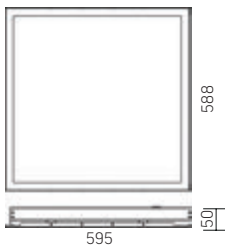

Package size of the lamp:  
627×614×62mm  
PF ≥ 0,95



○ white

Article	Power	Light temperature	Luminous flux
V1-A2-00065-10HG0-2003630	36W	3000K	3200 lm
V1-A2-00065-10HG0-2003640	36W	4000K	3900 lm
V1-A2-00065-10HG0-2003640	36W	5000K	3900 lm

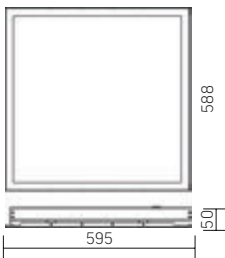
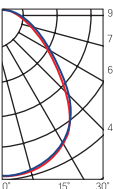

### **A** Autonomous emergency lamp permanent action

Emergency power supply unit, battery for 1 hour of autonomous operation, charge indicator, "Test" button in the set (see description on page 266)

#### Conformity:

GOST IEC 60598-2-22:2012 "Luminaries. Part 2-22.  
Private requirements. Luminaries for emergency lighting "SP 52.13330.2011" Natural and artificial lighting "(updated edition of SNiP 23.05-95)

Article	Power	Light temperature	Luminous flux
V1-A2-00065-10HG0-2003630	36W	3000K	3200 lm
V1-A2-00065-10HG0-2003640	36W	4000K	3900 lm
V1-A2-00065-10HG0-2003640	36W	5000K	3900 lm

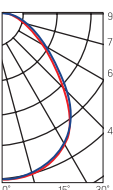

#### Installation:

Built in Ecophon ceilings (ceiling type Gedina D)

#### Case:

All-metal housing made from sheet steel with white powder coating

#### Specifications:

Index of color transmission Ra > 80

Temperature range from +1 °C to +40 °C

AC176-264V

Network frequency 50Hz ± 10%

LED life 50,000 hours

3 year warranty

Luminous flux Kn ≤ 1%





**Installation:**

Built in suspended ceilings Cesal

**Case:**

All-metal housing made of sheet steel with white powder coating  
To ensure the degree of protection IP54 around the perimeter of the body is fixed silicone seal

Application of luminaire with degree of protection IP54:

Medical facilities, restaurants, food processing facilities, canteens, laboratories, toilets, rooms with high humidity

**Diffuser:**

IP54 version with protection opal polycarbonate diffuser

**Specifications:**

Index of color transmission Ra > 80

Temperature range from -20 ° C to + 40 ° C

AC176-264V

Network frequency 50Hz ± 10%

LED life 50,000 hours



**Varton для Cesal**

600×600×62mm

IP54

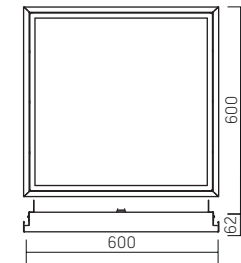

Package size of the lamp:  
627×614×62mm  
PF ≥ 0,95



○ white

Article	Power	Light temperature	Luminous flux
V1-A3-00027-10000-5403630	36W	3000K	3500 lm
V1-A3-00027-10000-5403640	36W	4000K	3700 lm
V1-A3-00027-10000-5403665	36W	6500K	3700 lm

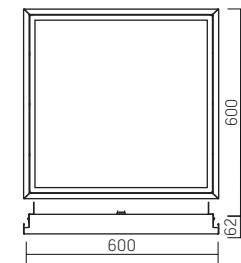
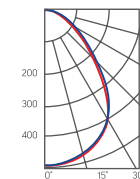

**Autonomous emergency lamp permanent action**

Emergency power supply unit, battery for 1 hour of autonomous operation, charge indicator, "Test" button in the set (see description on page 266)

**Conformity:**  
GOST IEC 60598-2-22-2012 "Luminaries. Part 2-22.

Private requirements. Luminaries for emergency lighting "SP 52. 13330. 2011" Natural and artificial lighting" (updated edition of SNiP 23.05-95)

Article	Power	Light temperature	Luminous flux
V1-A3-00027-10A00-5403630	36W	3000K	3500 lm
V1-A3-00027-10A00-5403640	36W	4000K	3700 lm
V1-A3-00027-10A00-5403665	36W	6500K	3700 lm

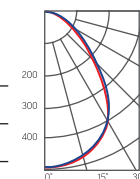

## Varton для Cesal

600×600×58mm  
IP40

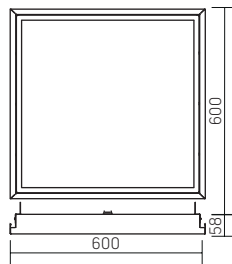

Package size of the lamp:  
627×614×62mm  
PF ≥ 0,95



○ white

Article	Power	Light temperature	Luminous flux
V1-A3-00027-10000-4003630	36W	3000K	3900 lm
V1-A3-00027-10000-4003640	36W	4000K	4200 lm
V1-A3-00027-10000-4003665	36W	6500K	4200 lm

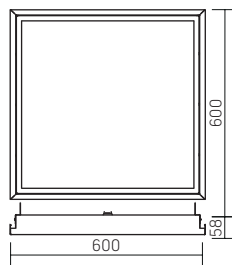
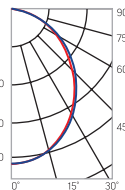

## Autonomous emergency lamp permanent action

Emergency power supply unit, battery for 1 hour of autonomous operation, charge indicator, "Test" button in the set (see description on page 266)

**Conformity:**  
GOST IEC 60598-2-22-2012 "Luminaries. Part 2-22.  
Private requirements. Luminaries for emergency lighting "SP 52.13330.2011" Natural and artificial lighting "(updated edition of SNIP 23.05-95)

Article	Power	Light temperature	Luminous flux
V1-A3-00027-10A00-4003630	36W	3000K	3900 lm
V1-A3-00027-10A00-4003640	36W	4000K	4200 lm
V1-A3-00027-10A00-4003665	36W	6500K	4200 lm

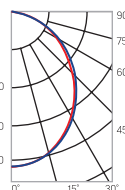

Diffuser (optional)  
Pack size of diffuser (2 pcs.):  
610×610×16mm

Article	Type	Diffuser size
V2-A1-PR00-00.2.0032.25	Prism standard	540×550mm
V2-A1-OP00-03.2.0032.15	Opal	540×550mm
V2-A1-PS00-00.2.0032.20	Pin spot	540×550mm
V2-A1-CI00-00.2.0032.20	Crushed ice	540×550mm
V2-A1-MP00-02.2.0032.20	Microprism	540×550mm

\* Luminous Flux Set excluding the diffuser







**GRILIATO**

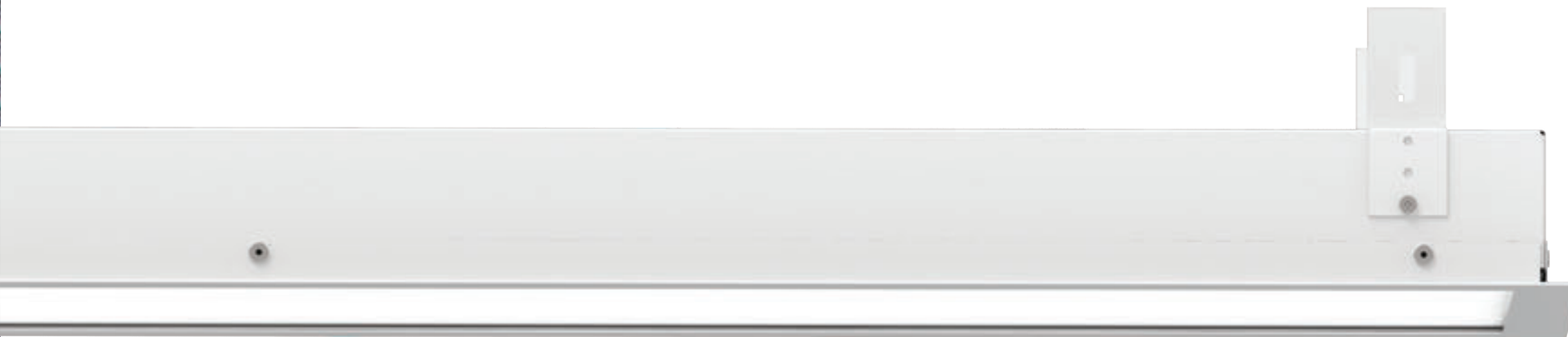

# GRILIATO

Lamps for ceilings GRILIATO

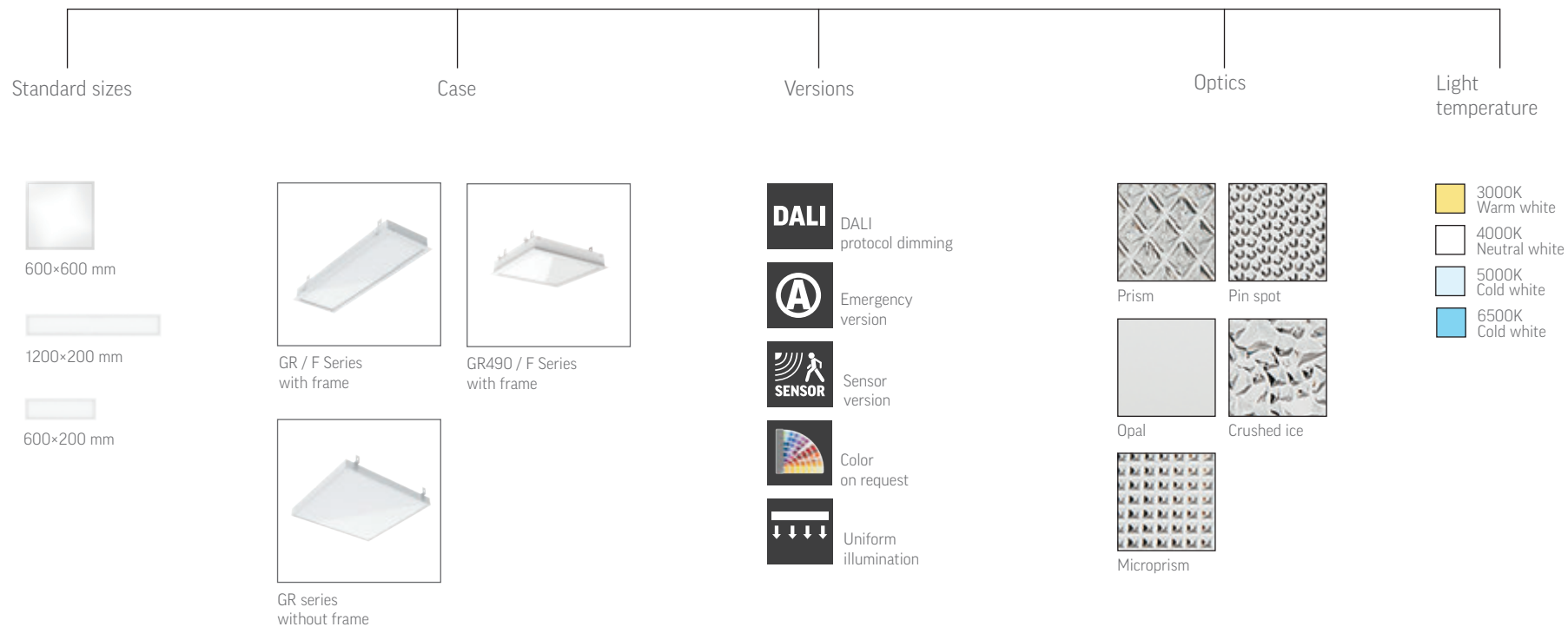

## GR070 2.0 IP40

588×588×50mm

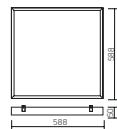

625×615×60mm

Package size of the lamp:

625×615×60 mm

PF ≥0,93



○ white



Article	Power	Light temperature	Luminous flux*	Diffuser
V1-R3-00010-310P0-2003030	30W	3000K	3000 lm	Opal
V1-R3-00010-31PR0-2003030	30W	3000K	3600 lm	Prism
V1-R3-00010-310P0-2004530	45W	3000K	4500 lm	Opal
V1-R3-00010-31PR0-2004530	45W	3000K	5500 lm	Prism
V1-R3-00010-310P0-20030XX	30W	4000K/5000K/6500K	3200 lm	Opal
V1-R3-00010-31PR0-20030XX	30W	4000K/5000K/6500K	3900 lm	Prism
V1-R3-00010-310P0-20045XX	45W	4000K/5000K/6500K	4700 lm	Opal
V1-R3-00010-31PR0-20045XX	45W	4000K/5000K/6500K	5800 lm	Prism

XX - 40 - LT 4000K  
XX - 50 - LT 5000K  
XX - 65 - LT 6500K

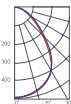
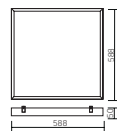

## DALI

625×615×60mm

Package size of the lamp:

625×615×60 mm

PF ≥0,93

○ white



Article	Power	Light temperature	Luminous flux*	Diffuser
V1-R3-00010-310PD-2003030	30W	3000K	3000 lm	Opal
V1-R3-00010-31PRD-2003030	30W	3000K	3600 lm	Prism
V1-R3-00010-310PD-2004530	45W	3000K	4500 lm	Opal
V1-R3-00010-31PRD-2004530	45W	3000K	5500 lm	Prism
V1-R3-00010-310PD-20030XX	30W	4000K/5000K/6500K	3200 lm	Opal
V1-R3-00010-31PRD-20030XX	30W	4000K/5000K/6500K	3900 lm	Prism
V1-R3-00010-310PD-20045XX	45W	4000K/5000K/6500K	4700 lm	Opal
V1-R3-00010-31PRD-20045XX	45W	4000K/5000K/6500K	5800 lm	Prism

XX - 40 - LT 4000K  
XX - 50 - LT 5000K  
XX - 65 - LT 6500K

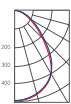
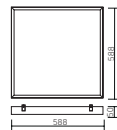

## Autonomous emergency lamp permanent action

Emergency power supply unit, battery for 1 hour of autonomous operation, charge indicator, "Test" button in the set (see description on page 266)

### Conformity:

GOST IEC 60598-2-22-2012 "Luminaries. Part 2-22. Private requirements.

Luminaries for emergency lighting "SP 52. 13330. 2011" Natural and artificial lighting "(updated edition of SNiP 23.05-95)

Article	Power	Light temperature	Luminous flux*	Diffuser
V1-R3-00010-310PA-2003030	30W	3000K	3000 lm	Opal
V1-R3-00010-31PRA-2003030	30W	3000K	3600 lm	Prism
V1-R3-00010-310PA-2004530	45W	3000K	4500 lm	Opal
V1-R3-00010-31PRA-2004530	45W	3000K	5500 lm	Prism
V1-R3-00010-310PA-20030XX	30W	4000K/5000K/6500K	3200 lm	Opal
V1-R3-00010-31PRA-20030XX	30W	4000K/5000K/6500K	3900 lm	Prism
V1-R3-00010-310PA-20045XX	45W	4000K/5000K/6500K	4700 lm	Opal
V1-R3-00010-31PRA-20045XX	45W	4000K/5000K/6500K	5800 lm	Prism

XX - 40 - LT 4000K  
XX - 50 - LT 5000K  
XX - 65 - LT 6500K

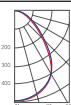
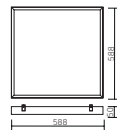

НОВАЯ  
МОДЕЛЬ

### Installation:

The lamp is installed in the grilyato ceilings with the height of the guides 30/40/50 mm

### Case:

All-metal housing made of sheet steel with white powder coating

### Diffuser:

Complete with opal or prismatic diffuser

### Specifications:

Index of color transmission Ra > 80

Temperature range from + 1 ° C to + 40 ° C

AC176-264V

Network frequency 50Hz ± 10%

LED life 50,000 hours

3 year warranty

Luminous flux ≤ 1%



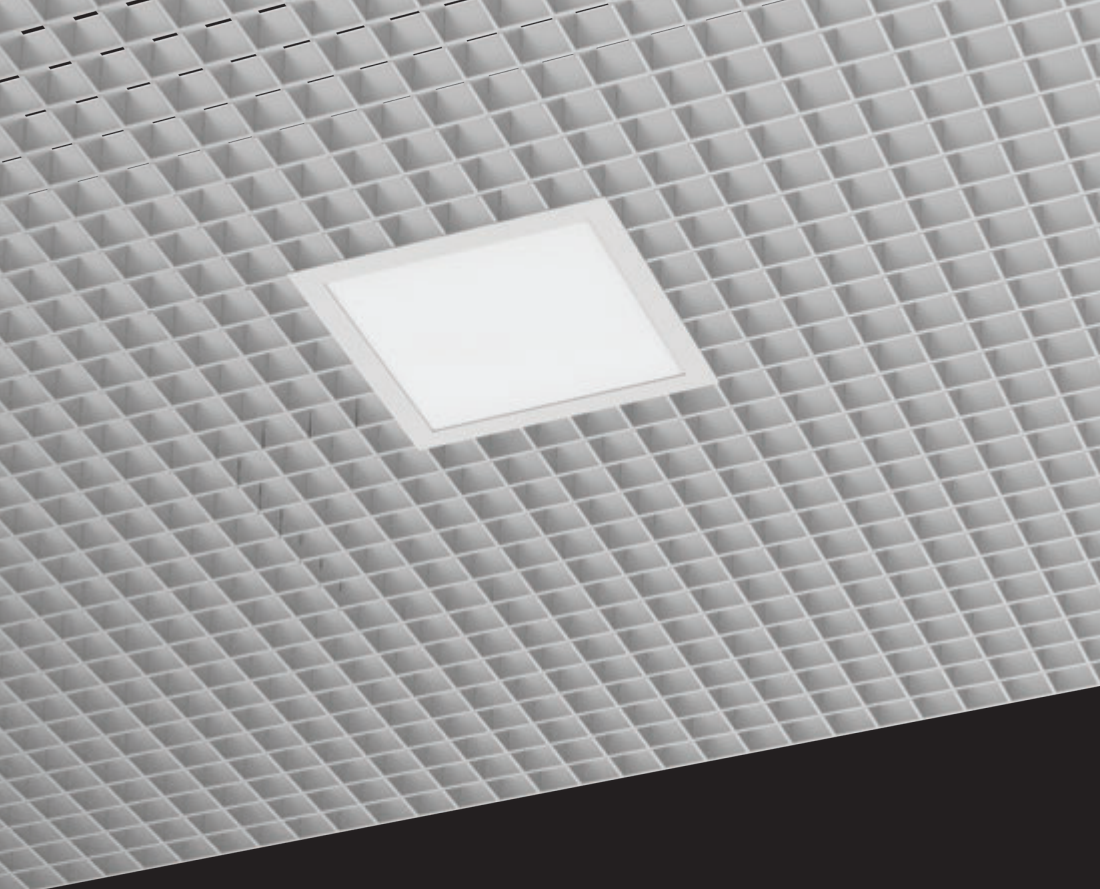

**GR490/F**  
312x312x50mm with frame

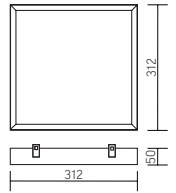

Lamp Size: 312x312x50 mm  
Mounting size: 291x291 mm  
Package size of the lamp:  
315x315x60 mm  
PF ≥0,95



○ white

Article	Power	Light temperature	Luminous flux*	Diffuser
V1-R3-00515-31PR0-2002540	25W	4000K	2500 lm	Prism
V1-R3-00515-31PR0-2003840	38W	4000K	4000 lm	Prism
V1-R3-00515-31OP0-2002540	25W	4000K	2200 lm	Opal
V1-R3-00515-31OP0-2003840	38W	4000K	3200 lm	Opal

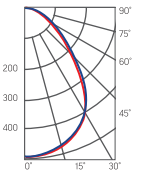

**Installation:**

The lamp is installed in the ceiling Griliato

**Case:**

All-metal housing made of sheet steel with white powder coating

**Specifications:**

Index of color transmission Ra > 82

Temperature range from + 1 ° C to + 40 ° C

AC176-264V

Network frequency 50Hz +/- 10%

LED life 50,000 hours

3 year warranty

luminous flux Kn <1%



## GR070

588×588×50mm

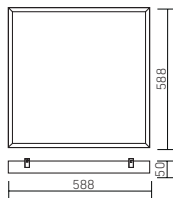

625×615×60mm

PF ≥ 0,95



○ white

Article	Power	Light temperature	Luminous flux*
V1-R3-00010-31000-2002730	27W	3000K	3400 lm
V1-R3-00010-31000-2002740	27W	4000K	3500 lm
V1-R3-00010-31000-2002750	27W	5000K	3500 lm
V1-R3-00010-31000-2002765	27W	6500K	3600 lm
V1-R3-00010-31000-2003630	36W	3000K	4400 lm
V1-R3-00010-31000-2003640	36W	4000K	4600 lm
V1-R3-00010-31000-2003650	36W	5000K	4600 lm
V1-R3-00010-31000-2003665	36W	6500K	4700 lm
V1-R3-00010-31000-2005430	54W	3000K	6400 lm
V1-R3-00010-31000-2005440	54W	4000K	6600 lm
V1-R3-00010-31000-2005450	54W	5000K	6600 lm
V1-R3-00010-31000-2005465	54W	6500K	6800 lm

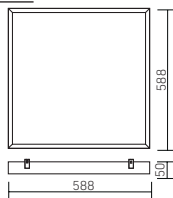
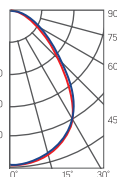

### **A** Autonomous emergency lamp permanent action

Emergency power supply unit, battery for 1 hour of autonomous operation, charge indicator, "Test" button in the set (see description on page 266)

#### Conformity:

GOST IEC 60598-2-22:2012 "Luminaries. Part 2-22. Private requirements. Luminaries for emergency lighting "SP 52. 13330. 2011" Natural and artificial lighting "(updated edition of SNiP 23.05-95)

Article	Power	Light temperature	Luminous flux*
V1-R3-00010-31A00-2003630	36W	3000K	4400 lm
V1-R3-00010-31A00-2003640	36W	4000K	4600 lm
V1-R3-00010-31A00-2003650	36W	5000K	4600 lm
V1-R3-00010-31A00-2003665	36W	6500K	4700 lm
V1-R3-00010-31A00-2005430	54W	3000K	6400 lm
V1-R3-00010-31A00-2005440	54W	4000K	6600 lm
V1-R3-00010-31A00-2005450	54W	5000K	6600 lm
V1-R3-00010-31A00-2005465	54W	6500K	6800 lm

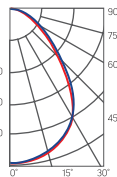

Diffuser (optional)

Pack size of diffuser

(2 pcs.): 610×610×16mm

Article	Type	Diffuser size
V2-R0-PR00-00.2.0005.25	Prism standard	582×582mm
V2-R0-OP00-03.2.0005.15	Opal	582×582mm
V2-A0-PS00-00.2.0005.20	Pin spot	582×582mm
V2-R0-CI00-00.2.0005.20	Crushed ice	582×582mm
V2-R0-MP00-02.2.0005.20	Microprism	582×582mm

\*Luminous Flux Set excluding the diffuser

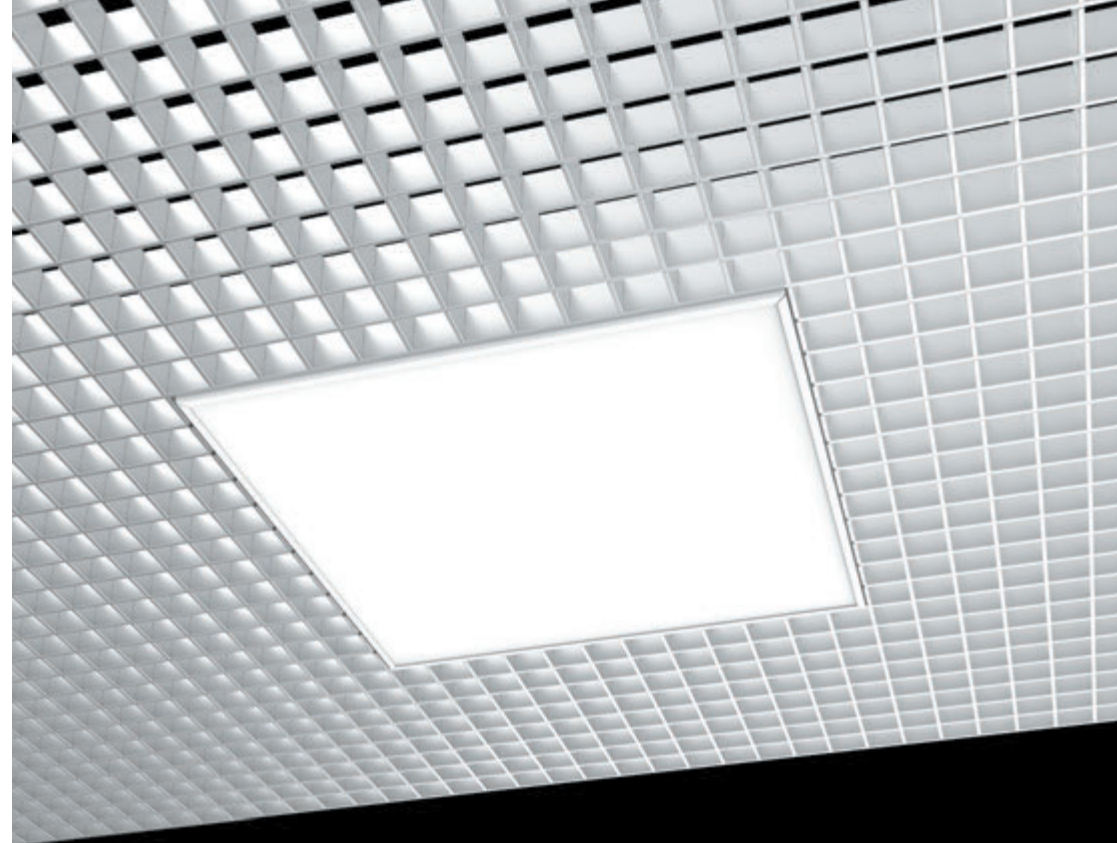

#### Installation:

Mounted on euro-hangers directly to the ceiling base through special strips fixed in the luminaire body to Grilyato-type ceilings. The mounting height of the luminaire relative to the ceiling is adjusted using slats. The luminaires are suitable for ceilings with height 30/40/50mm

#### Case:

All-metal housing made of sheet steel with white powder coating

#### Application:

Griliato ceilings (shopping centers, offices)

#### Specifications:

Index of color transmission Ra > 80

Temperature range from +1 °C to +40 °C

AC176-264V

Network frequency 50Hz ± 10%

LED life 50,000 hours

3 year warranty

Luminous flux Kn ≤ 1%



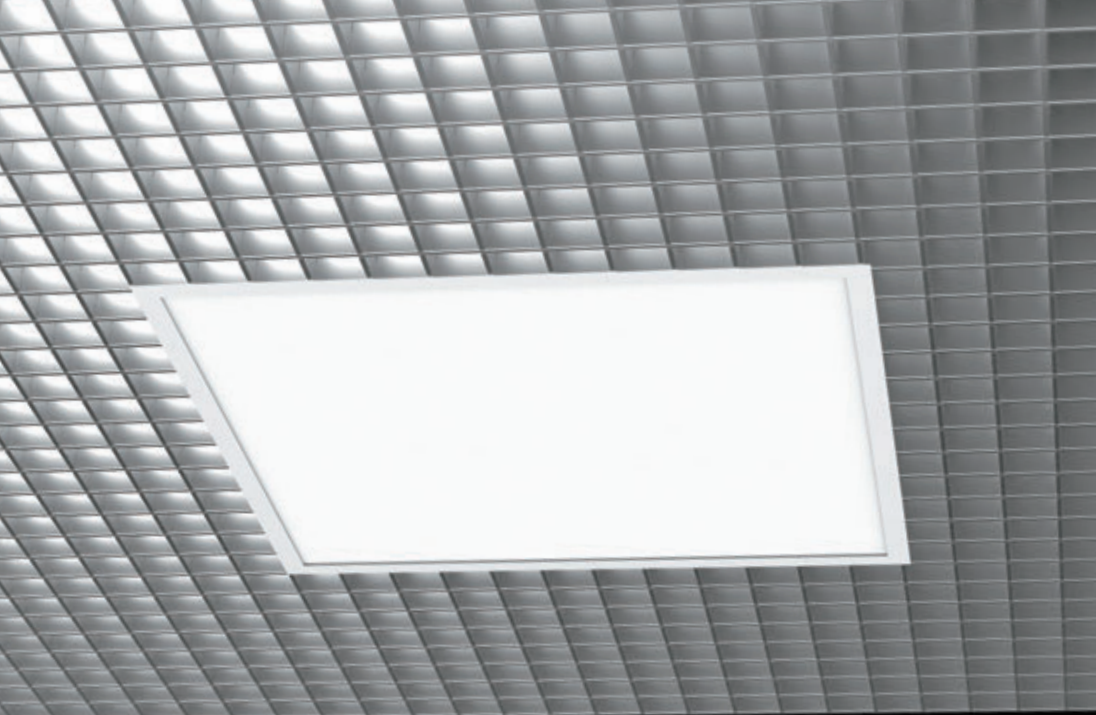

**GR070/F**  
619×619×50mm

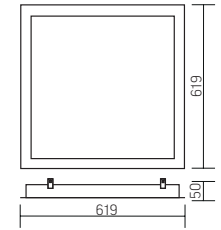

Mounting size: 588x588 mm  
625×615×60mm  
PF ≥ 0,95



Article	Power	Light temperature	Luminous flux*
V1-R3-00010-30000-2003630	36W	3000K	4400 lm
V1-R3-00010-30000-2003640	36W	4000K	4600 lm
V1-R3-00010-30000-2003650	36W	5000K	4600 lm
V1-R3-00010-30000-2003665	36W	6500K	4700 lm
V1-R3-00010-30000-2005430	54W	3000K	6400 lm
V1-R3-00010-30000-2005440	54W	4000K	6600 lm
V1-R3-00010-30000-2005450	54W	5000K	6600 lm
V1-R3-00010-30000-2005465	54W	6500K	6800 lm

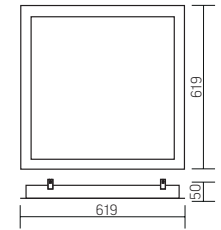
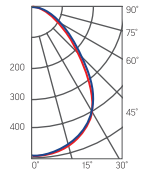

**Installation:**

Mounted on euro-hangers directly to the ceiling base through special strips fixed in the luminaire body to Griliato-type ceilings. The mounting height of the luminaire relative to the ceiling is adjusted using slats. The luminaires are suitable for ceilings with height 30/40/50mm

**Case:**

All-metal housing made of sheet steel with white powder coating. The case has a decorative frame that allows you to hide defects in the preparation of non-standard holes in the guide rails of the ceiling.

**Specifications:**

- Index of color transmission Ra > 80
- Temperature range from + 1 ° C to + 40 ° C
- AC176-264V
- Network frequency 50Hz ± 10%
- LED life 50,000 hours
- 3 year warranty
- Luminous flux Kn ≤ 1%



**Autonomous emergency lamp permanent action**

Emergency power supply unit, battery for 1 hour of autonomous operation, charge indicator, "Test" button in the set (see description on page 266)

**Conformity:**

GOST IEC 60598-2-22-2012 "Luminaires. Part 2-22. Private requirements. Luminaires for emergency lighting "SP 52. 13330. 2011" Natural and artificial lighting "(updated edition of SNiP 23.05-95)



Diffuser (optional) Pack size of diffuser (2 pcs.): 610×610×16mm

Article	Power	Light temperature	Luminous flux*
V1-R3-00010-30A00-2003630	36W	3000K	4400 lm
V1-R3-00010-30A00-2003640	36W	4000K	4600 lm
V1-R3-00010-30A00-2003650	36W	5000K	4600 lm
V1-R3-00010-30A00-2003665	36W	6500K	4700 lm
V1-R3-00010-30A00-2005430	54W	3000K	6400 lm
V1-R3-00010-30A00-2005440	54W	4000K	6600 lm
V1-R3-00010-30A00-2005450	54W	5000K	6600 lm
V1-R3-00010-30A00-2005465	54W	6500K	6800 lm

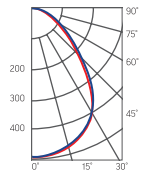

Article	Type	Diffuser size
V2-R0-PR00-00.2.0005.25	Prism standard	582×582mm
V2-R0-0P00-03.2.0005.15	Opal	582×582mm
V2-A0-PS00-00.2.0005.20	Pin spot	582×582mm
V2-R0-CI00-00.2.0005.20	Crushed ice	582×582mm
V2-R0-MP00-02.2.0005.20	Microprism	582×582mm

\* Luminous Flux Set excluding the diffuser





Shopping center "Yantarny" (Bryansk, Russia)

**GR170/F**  
610×202×50mm

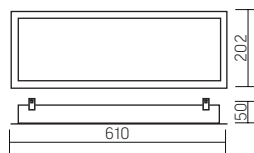

Package size of the lamp:  
588×199×62mm  
Mounting size: 588×180 mm  
PF ≥ 0,95



Article	Power	Light temperature	Luminous flux*
V1-R3-00069-30000-2001830	18W	3000K	2000 lm
V1-R3-00069-30000-2001840	18W	4000K	2100 lm
V1-R3-00069-30000-2001850	18W	5000K	2100 lm
V1-R3-00069-30000-2001865	18W	6500K	2200 lm

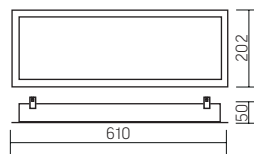
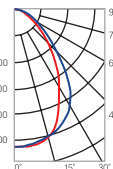

**A Autonomous emergency lamp permanent action**

Emergency power supply unit, battery for 1 hour of autonomous operation, charge indicator, "Test" button in the set (see description on page 266)

**Conformity:**  
GOST IEC 60598-2-22-2012 "Luminaries. Part 2-22.  
Private requirements. Luminaries for emergency lighting "SP 52. 13330. 2011" Natural and artificial lighting "(updated edition of SNIP 23.05-95)

Article	Power	Light temperature	Luminous flux*
V1-R3-00069-30A00-2001830	18W	3000K	2000 lm
V1-R3-00069-30A00-2001840	18W	4000K	2100 lm
V1-R3-00069-30A00-2001850	18W	5000K	2100 lm
V1-R3-00069-30A00-2001865	18W	6500K	2200 lm

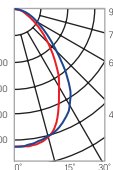

Diffuser (optional)  
Pack size of diffuser (2 pcs):  
610×190×16mm

Article	Type	Diffuser size
V2-R0-PR00-00.2.0004.25	Prism standard	582×174mm
V2-R0-OP00-03.2.0004.15	Opal	582×174mm
V2-R0-PS00-00.2.0004.20	Pin spot	582×174mm
V2-R0-CI00-00.2.0004.20	Crushed ice	582×174mm
V2-R0-MP00-02.2.0004.20	Microprism	582×174mm

\* Luminous Flux Set excluding the diffuser

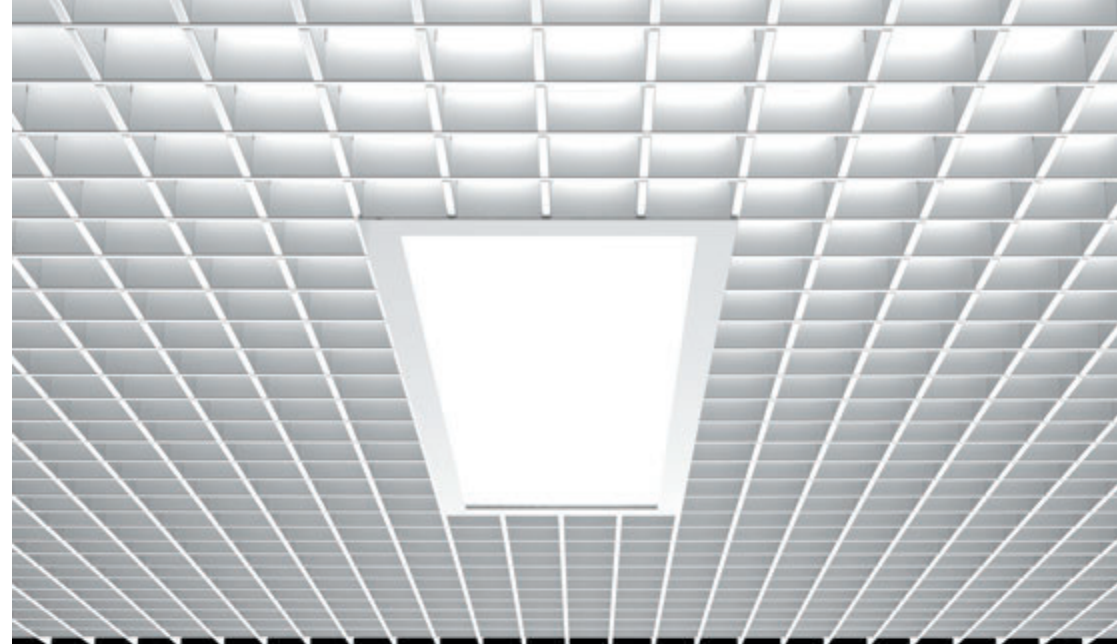

**Installation:**

Mounted on euro-hangers directly to the ceiling base through special strips fixed in the luminaire body to Grilyato-type ceilings. The mounting height of the luminaire relative to the ceiling is adjusted using slats. The luminaires are suitable for ceilings with height 30/40 / 50mm

**Case:**

All-metal housing made of sheet steel with white powder coating. The case has a decorative frame that allows you to hide defects in the preparation of non-standard holes in the guide rails of the ceiling.

**Specifications:**

Index of color transmission Ra > 80  
Temperature range from + 1 ° C to + 40 ° C  
AC176-264V  
Network frequency 50Hz ± 10%  
LED life 50,000 hours  
3 year warranty  
Luminous flux Kn ≤ 1%





**GR270/F**  
1210×202×50mm

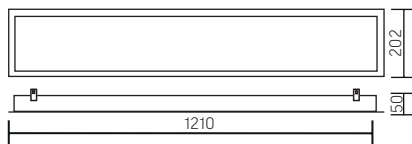

Package size of the lamp:  
1234×199×62mm  
Mounting size: 1188×180 mm  
PF ≥ 0,95



○ white

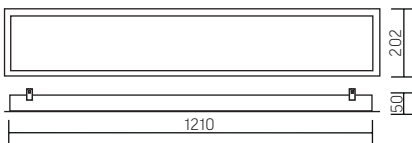

Article	Power	Light temperature	Luminous flux*
V1-R3-00042-30000-2003630	36W	3000K	4100 lm
V1-R3-00042-30000-2003640	36W	4000K	4300 lm
V1-R3-00042-30000-2003650	36W	5000K	4300 lm
V1-R3-00042-30000-2003665	36W	6500K	4300 lm
V1-R3-00042-30000-2005430	54W	3000K	6000 lm
V1-R3-00042-30000-2005440	54W	4000K	6100 lm
V1-R3-00042-30000-2005450	54W	5000K	6100 lm
V1-R3-00042-30000-2005465	54W	6500K	6200 lm

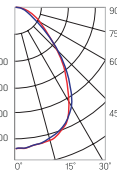

**A** Autonomous emergency lamp permanent action

Emergency power supply unit, battery for 1 hour of autonomous operation, charge indicator, "Test" button in the set (see description on page 266)

**Conformity:**  
GOST IEC 60598-2-22-2012 "Luminaires. Part 2-22. Private requirements. Luminaires for emergency lighting "SP 52. 13330. 2011" Natural and artificial lighting "(updated edition of SNIP 23.05-95)

Article	Power	Light temperature	Luminous flux*
V1-R3-00042-30A00-2003630	36W	3000K	4100 lm
V1-R3-00042-30A00-2003640	36W	4000K	4300 lm
V1-R3-00042-30A00-2003650	36W	5000K	4300 lm
V1-R3-00042-30A00-2003665	36W	6500K	4300 lm
V1-R3-00042-30A00-2005430	54W	3000K	6000 lm
V1-R3-00042-30A00-2005440	54W	4000K	6100 lm
V1-R3-00042-30A00-2005450	54W	5000K	6100 lm
V1-R3-00042-30A00-2005465	54W	6500K	6200 lm

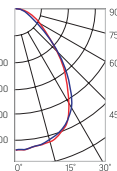

Diffuser (optional) Pack size of diffuser (2 pcs.): 1205×190×18mm

Article	Type	Diffuser size
V2-R0-PR00-00.2.0022.25	Prism standard	1182×174mm
V2-R0-OP00-03.2.0022.15	Opal	1182×174mm
V2-R0-PS00-00.2.0022.20	Pin spot	1182×174mm
V2-R0-CI00-00.2.0022.20	Crushed ice	1182×174mm
V2-R0-MP00-02.2.0022.20	Microprism	1182×174mm

\* Luminous Flux Set excluding the diffuser

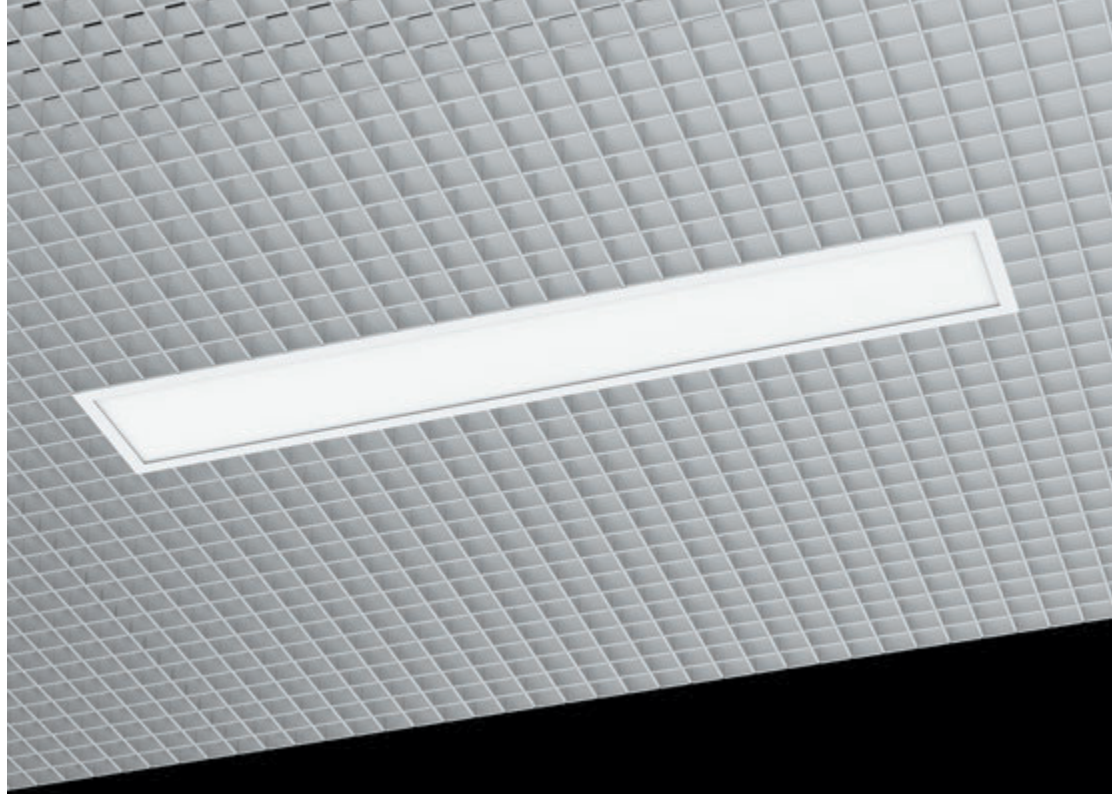

**Installation:**  
It is mounted on euro-hangers directly to the ceiling base through special strips fixed in the luminaire body to Grilyato-type ceilings. The mounting height of the luminaire relative to the ceiling is adjusted using slats. The luminaires are suitable for ceilings with height 30/40 / 50mm

**Case:**  
All-metal housing made of sheet steel with white powder coating. The case has a decorative frame that allows you to hide defects in the preparation of non-standard holes in the guide rails of the ceiling.

**Specifications:**  
Index of color transmission Ra > 80  
Temperature range from + 1 ° C to + 40 ° C  
AC176-264V  
Network frequency 50Hz ± 10%  
LED life 50,000 hours  
3 year warranty





Shopping center "Kurs" (Moscow, Russia)



**BASIC SERIES**

**A070 Basic**  
595×595×50mm

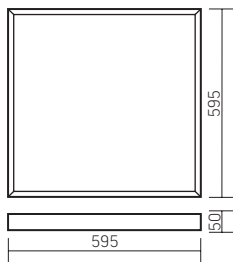

Package size of the lamp:  
627×614×62mm  
PF ≥ 0,97



○ white

Article	Power	Light temperature	Luminous flux	Diffuser
B1-A0-00070-01G02-2003540	35W	4000K	3000 lm	Opal
B1-A0-00070-01G03-2003540	35W	4000K	3400 lm	Prism
B1-A0-00070-01G02-2003550	35W	5000K	3300 lm	Opal
B1-A0-00070-01G03-2003550	35W	5000K	3600 lm	Prism
B1-A0-00070-01G02-2006040	60W	4000K	5400 lm	Opal
B1-A0-00070-01G03-2006040	60W	4000K	6000 lm	Prism
B1-A0-00070-01G02-2006050	60W	5000K	5600 lm	Opal
B1-A0-00070-01G03-2006050	60W	5000K	6200 lm	Prism

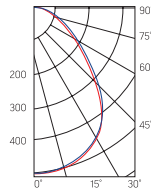

**Installation:**

Embedded in suspended ceiling systems with a T-profile width of 24 mm or mounted on a flat surface

**Case:**

All-metal housing made of sheet steel with white powder coating

**Specifications:**

Index of color transmission Ra > 80

Temperature range from + 1 ° C to + 40 ° C

AC198-242V

Network frequency 50Hz ± 10%

LED life 50,000 hours

2 year warranty

Luminous flux Kn ≤2%



**A170 Basic**  
595×180×50mm

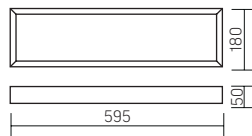

Lamp Size: 595×180×50 mm  
Package size of the lamp:  
600×180×66 mm  
PF ≥ 0,95



○ white

Article	Power	Light temperature	Luminous flux	Diffuser
B1-A0-00170-01G02-2001840	18W	4000K	1400 lm	Opal
B1-A0-00170-01G03-2001840	18W	4000K	1600 lm	Prism
B1-A0-00170-01G02-2001850	18W	5000K	1400 lm	Opal
B1-A0-00170-01G03-2001850	18W	5000K	1600 lm	Prism

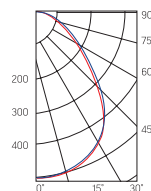

**Installation:**

Embedded in suspended ceiling systems with a T-profile width of 24 mm or mounted on a flat surface

**Case:**

All-metal housing made of sheet steel with white powder coating

**Specifications:**

Index of color transmission Ra > 80

Temperature range from + 1 ° C to + 40 ° C

AC198-242V

Network frequency 50Hz +/- 10%

LED life 50,000 hours

2 year warranty

Luminous flux Kn <2%





**A270 Basic**  
1195×180×50mm

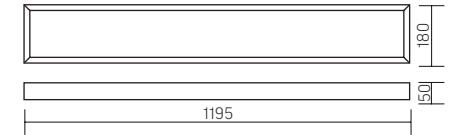

Package size of the lamp:  
1195×180×50mm  
Package size of the lamp:  
1232×199×62 mm  
PF ≥ 0,97



Article	Power	Light temperature	Luminous flux	Diffuser
B1-A0-00270-01G02-2003540	35W	4000K	2800 lm	Opal
B1-A0-00270-01G03-2003540	35W	4000K	3200 lm	Prism
B1-A0-00270-01G02-2003550	35W	5000K	2900 lm	Opal
B1-A0-00270-01PRO-2003550	35W	5000K	3300 lm	Prism
B1-A0-00270-01G02-2006040	60W	4000K	4600 lm	Opal
B1-A0-00270-01G03-2006040	60W	4000K	5200 lm	Prism
B1-A0-00270-01G02-2006050	60W	5000K	4800 lm	Opal
B1-A0-00270-01G03-2006050	60W	5000K	5400 lm	Prism

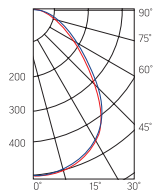

**Installation:**  
Embedded in suspended ceiling systems with a T-profile width of 24 mm or mounted on a flat surface

**Case:**  
All-metal housing made of sheet steel with white powder coating

**Specifications:**  
Index of color transmission Ra > 80  
Temperature range from + 1 ° C to + 40 ° C  
AC198-242V  
Network frequency 50Hz ± 10%  
LED life 50,000 hours  
2 year warranty  
Luminous flux Kn ≤2%



## FL Basic

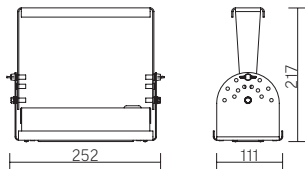

Lamp Size:  
252×111×217mm  
Package size of the lamp:  
331×268×167mm  
PF ≥ 0,99



○ metal

Article	Power	Light temperature	Luminous flux
V1-I0-70356-04L05-6503050	30W	5000K	2900lm

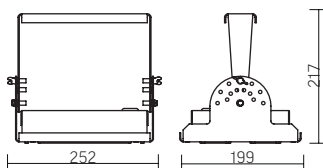
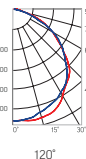

Lamp Size:  
252×199×217mm  
Package size of the lamp:  
331×268×167mm  
PF ≥ 0,99



○ metal

Article	Power	Light temperature	Luminous flux
V1-I0-70357-04L05-6506050	60W	5000K	5700lm

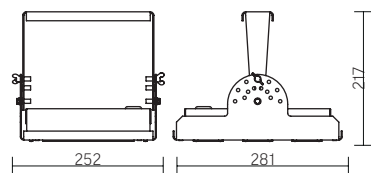
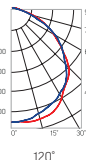

Lamp Size:  
252×281×217mm  
Package size of the lamp:  
395×310×165mm  
PF ≥ 0,99



○ metal

Article	Power	Light temperature	Luminous flux
V1-I0-70358-04L05-6509050	90W	5000K	8800lm

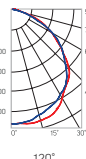

### Application:

Designed to illuminate warehouses, exhibition sites, construction sites, lighting architectural elements of buildings.

### Installation:

Fastening on walls, ceiling and floor with the ability to adjust the angle of inclination within 180°

### Case:

Painted metal body. Aluminum LED Module Cooling Radiator  
Resistant to Physical Impact and Corrosion

### LED Protection:

Polycarbonate protective cover UV resistant

### Specifications:

Index of color transmission Ra > 75  
Temperature range from -40 °C to + 45 °C  
AC200-264V, 50 Hz  
LED life 50,000 hours  
2 year warranty





### Strong Basic

674×90×68mm

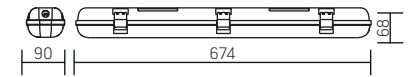

AC198-242V  
 Package size of the lamp:  
 700×100×75mm  
 PF ≥ 0,97



Article	Power	Diffuser	Light temperature	Luminous flux*
B1-I2-70215-03000-6501840	18W	Clear	4000K	1700lm
B1-I2-70215-03000-6501850	18W	Clear	5000K	1700lm
B1-I2-70215-03G02-6501840	18W	Matt	4000K	1600lm
B1-I2-70215-03G02-6501850	18W	Matt	5000K	1600lm

### Strong Basic

1242×90×68mm

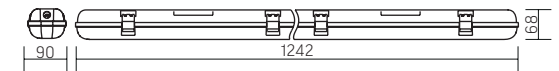

AC198-242V  
 Package size of the lamp:  
 1280×100×75mm  
 PF ≥ 0,97



Article	Power	Diffuser	Light temperature	Luminous flux*
B1-I2-70210-03000-6503540	35W	Clear	4000K	3300lm
B1-I2-70210-03000-6503550	35W	Clear	5000K	3300lm
B1-I2-70210-03G02-6503540	35W	Matt	4000K	3100lm
B1-I2-70210-03G02-6503550	35W	Matt	5000K	3100lm
B1-I2-70210-03000-6506040	60W	Clear	4000K	5700lm
B1-I2-70210-03000-6506050	60W	Clear	5000K	5700lm
B1-I2-70210-03000-6506040	60W	Matt	4000K	5100lm
B1-I2-70210-03000-6506050	60W	Matt	5000K	5100lm

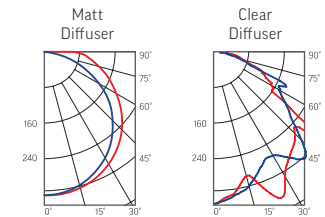

**Installation:**  
 Mount directly on a horizontal or vertical surface  
 Can be mounted on hangers

**Case:**  
 High impact self-extinguishing ABS plastic  
 It is completed with wearproof cable input

**Diffuser:**  
 Polycarbonate with UV stabilizer additives  
 Mounted to the body of the lamp on the latches

**Specifications:**  
 Index of color transmission Ra > 80  
 Temperature range from -20 ° C to + 45 ° C  
 Network frequency 50Hz ± 10%  
 LED life 50,000 hours  
 2 year warranty  
 Luminous flux Kn ≤2%





## Iron Basic

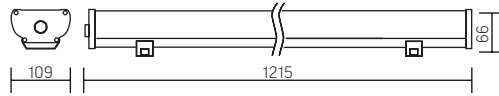

Lamp Size:  
1215x109x66mm  
Package size:  
1299x117x72mm



metal

Article	Power	Light temperature	Luminous flux
B1-IA-70072-03000-6703540	35W	4000K	3500lm
B1-IA-70072-03000-6703550	35W	5000K	3500lm
B1-IA-70072-03000-6703565	35W	6500K	3500lm

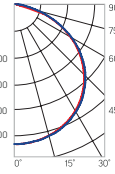

### Installation:

Mounted both on a flat surface, and on suspensions  
Easy installation and connection due to the wires removed from the lamp housing

### Case:

Aluminum anodized body  
Transparent PMMA (acrylic) diffuser, resistant to UV radiation and exposure to specific media  
Special silicone pads to ensure compliance with IP67 protection class

### Application:

Designed for general lighting in rooms with high humidity and dust, and increased reliability requirements

Specifications:

Input voltage AC198-242V

Index of color transmission Ra > 80

Power Factor  $\geq 0.97$

IP67 protection degree

Temperature range from -20 ° to + 40 ° C

2 year warranty



НОВАЯ  
МОДЕЛЬ



## TT-Basic

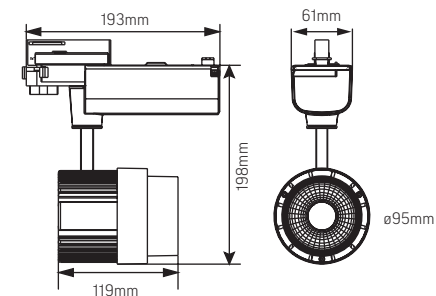

Lamp Size: 198x119x95 mm  
Package size of the lamp:  
255x233x108 mm  
PF ≥0,90



○ white

Article	Power	Light temperature	Luminous flux
V1-R0-00458-90XXX-2003040	30W	4000K	2700 lm

XXX = 000 - angle 36°  
XXX = L07 - angle 60°

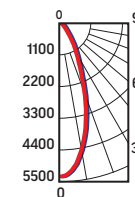

### Installation:

Built in 3 phase busline

### Case:

Aluminum

### Specifications:

Index of color transmission Ra > 80

Temperature range from + 1 ° C to + 40 ° C

AC220-240V

Network frequency 50Hz +/- 10%

LED life 50,000 hours

2 year warranty

Luminous flux Kn <5%



B

**GR070 Basic**  
588×588×50mm

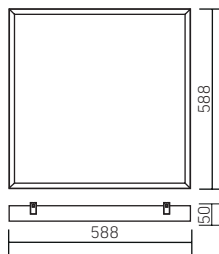

Package size of the lamp:  
625 × 615 × 60mm  
PF ≥ 0,97



Article	Power	Light temperature	Luminous flux	Diffuser
B1-R3-00010-31G02-2003540	35W	4000K	3000 lm	Opal
B1-R3-00010-31G03-2003540	35W	4000K	3400 lm	Prism
B1-R3-00010-31G02-2003550	35W	5000K	3300 lm	Opal
B1-R3-00010-31G03-2003550	35W	5000K	3600 lm	Prism
B1-R3-00010-31G02-2006040	60W	4000K	5400 lm	Opal
B1-R3-00010-31G03-2006040	60W	4000K	6000 lm	Prism
B1-R3-00010-31G02-2006050	60W	5000K	5600 lm	Opal
B1-R3-00010-31G03-2006050	60W	5000K	6200 lm	Prism

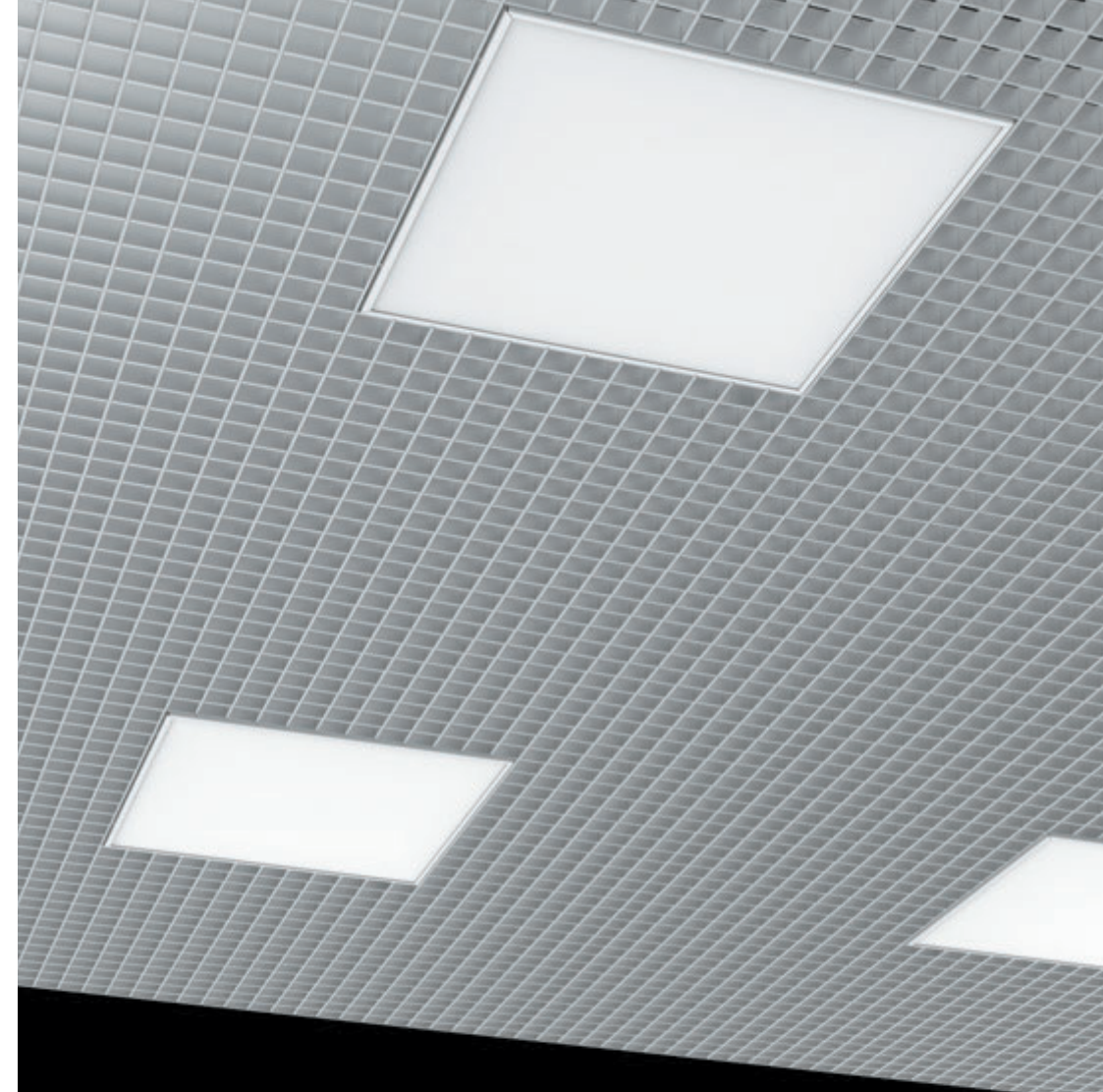
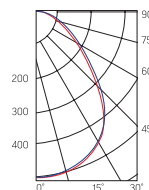

**Installation:**

Mounted in Grilyato-type ceilings on euro-hangers directly to the ceiling base through special strips fixed in the luminaire housing

**Case:**

All-metal housing made of sheet steel with white powder coating

**Specifications:**

- Index of color transmission Ra > 80
- Temperature range from + 1 ° C to + 40 ° C
- AC198-242V
- Network frequency 50Hz ± 10%
- LED life 50,000 hours
- 2 year warranty
- Luminous flux ≤2%



**Installation:**  
Clamping system  
The diameter of the hole 170mm (22W) and 200mm (30W)  
Built in plasterboard, stretch and slatted ceilings

**Body Material:**  
Heat resistant plastic

**Diffuser material:**  
Polycarbonate

**Specifications:**  
Index of color transmission Ra > 80  
Temperature range from +1 ° to +40 ° C  
AC220-240V  
Network frequency 50Hz +/- 10%  
LED life 50,000 hours  
2 year warranty  
Luminous flux Kn ≤ 5%  
Power supply inside the luminaire housing

## DL-Basic

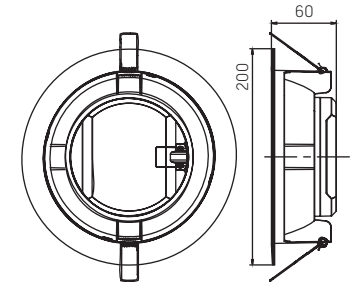

Lamp Size: 200x60mm  
Package size of the lamp:  
205x205x63mm  
PF ≥0,9



○ white

Article	Power	Light temperature	Luminous flux
V1-R0-00405-10000-2002240	22W	4000K	1500lm

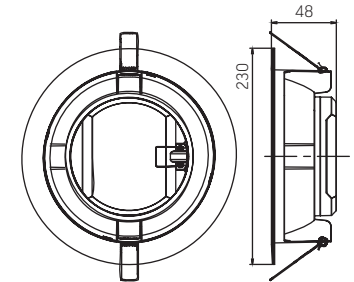
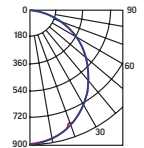

Lamp Size: 230x48mm  
Package size of the lamp:  
235x235x52mm  
PF ≥0,9



○ white

Article	Power	Light temperature	Luminous flux
V1-R0-00406-10000-2003040	30W	4000K	2400lm

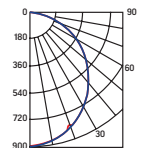

## Housing and utilities sector -Basic

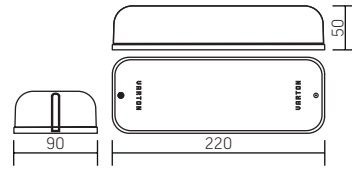

Lamp Size: 220x90x50mm  
 Package size of the lamp: 230x93x50mm  
 PF ≥0,9

Article	Power	Light temperature	Luminous flux
V1-U0-00006-21B00-6500850	8W	5000K	550lm

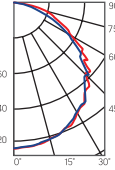

○ white



### Installation:

Surface mounted on horizontal / vertical surface

### Case Material:

High-impact heat-resistant ABS plastic

### Diffuser material:

Polycarbonate

### Specifications:

Index of color transmission Ra > 80

Temperature range from -25 ° to + 40 ° C

AC220-240V

Network frequency 50Hz +/- 10%

LED life 50,000 hours

2 year warranty

Luminous flux Kn ≤ 10%



**SENSORS AND CONTROL SYSTEMS**

# Infrared sensors

## V1-ST05AP

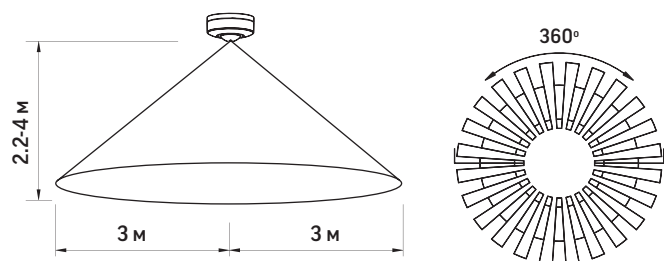

Power supply	220-240V/AC 50/60Hz
ambient light	<3-2000lux (variated)
Degree of protection	IP44
Maintaining light after leaving the detection area:	Minimum 10s±3s Maximum 15m±2m
Rated load	max. ⚡ 1200W 🔌 300W
Detection range	360°
Detection distance	max. 6m (<24°C)
operating temperature	-20~+40°C
Humidity	<93%RH
watt consumption	0.5W
Height of Fixture	2.2-4m
Detection rate	0.6-1.5m/c

## V1-ST06B

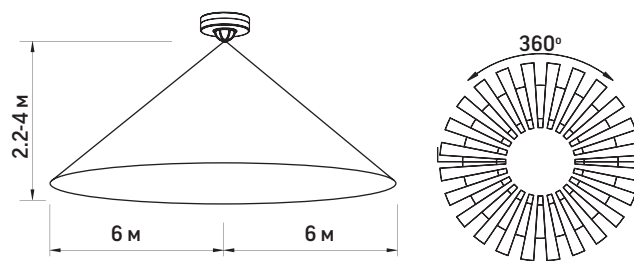

Power supply	220-240V/AC 50/60Hz
ambient light	<3-2000lux (variated)
Degree of protection:	IP20
Maintaining light after leaving the detection area:	Minimum 10s±3s Maximum 7m±2m
Rated load	max. ⚡ 1200W 🔌 300W
Detection range	360°
Detection distance	max. 3-12m (<24°C)
operating temperature	-20~+40°C
Humidity	<93%RH
watt consumption	0.5W
Height of Fixture	2.2-4m
Detection rate	0.6-1.5m/c

## V1-ST41

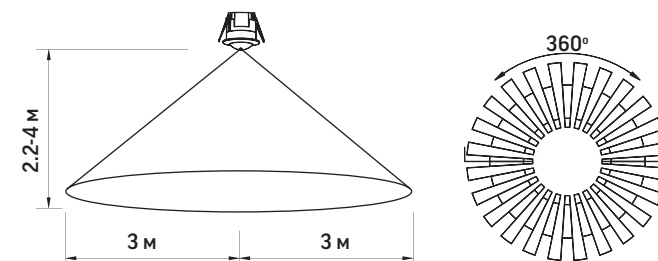

Power supply	220-240V/AC 50/60Hz
ambient light	<3-2000lux (variated)
Degree of protection:	IP20
Maintaining light after leaving the detection area:	Minimum 10s±3s Maximum 15m±2m
Rated load	Max. ⚡ 1200W 🔌 300W
Detection range	360°
Detection distance	Max. 6m (<24°C)
operating temperature	-20~+40°C
Humidity	<93%RH
watt consumption	0.5W
Height of Fixture	2.2-4m
Detection rate	0.6-1.5m/c



# Infrared sensors

## V1-ST09

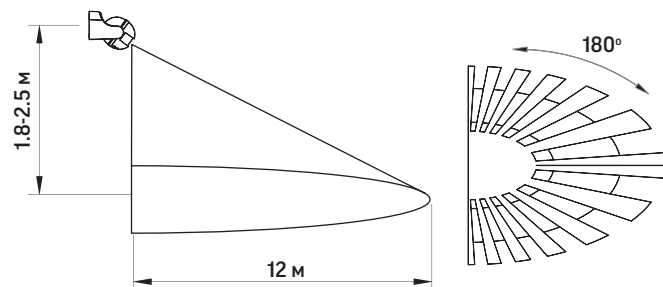

## V1-ST15

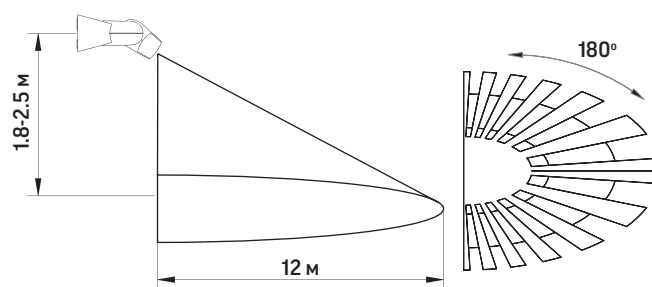

## V1-ST11

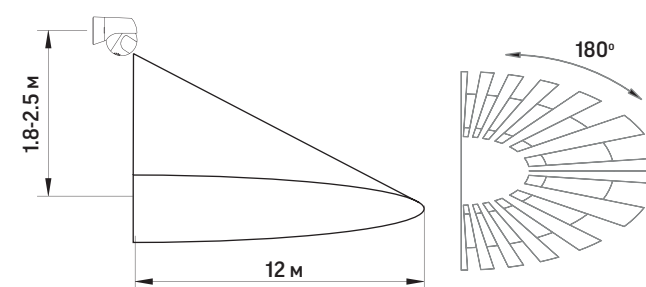

Power supply	220-240V/AC 50/60Hz
ambient light	<3-2000lux (variated)
Degree of protection	IP44
Maintaining light after leaving the detection area	Minimum 10s±3s Maximum 7m±2m
Rated load	Max.  1200W 300W
Detection range	180°
Detection distance	Max. 12m (<24°C)
operating temperature	-20~+40°C
Humidity	<93%RH
watt consumption	0.5W
Height of Fixtury	1.8-2.5m
Detection rate	0.6-1.5m/s

Power supply	220-240V/AC 50/60Hz
ambient light	<3-2000lux (variated)
Degree of protection	IP65
Maintaining light after leaving the detection area	Minimum 10s±3s Maximum 15m±2m
Rated load	Max.  1200W 300W
Detection range	180°
Detection distance	Max. 12m (<24°C)
operating temperature	-20~+40°C
Humidity	<93%RH
watt consumption	0.5W
Height of Fixtury	1.8-2.5m
Detection rate	0.6-1.5m/s

Power supply	220-240V/AC 50/60Hz
ambient light	<3-2000lux (variated)
Degree of protection	IP44
Delay	Minimal 10s±3s Maximal 15m±2m
Rated load	Max.  1200W 300W
Detection range	180°
Detection distance	Max. 12m (<24°C)
operating temperature	-20~+40°C
Humidity	<93%RH
watt consumption	0.5W
Height of Fixtury	1.8-2.5m
Detection rate	0.6-1.5m/s





# Infrared sensors

## V1-ST700C

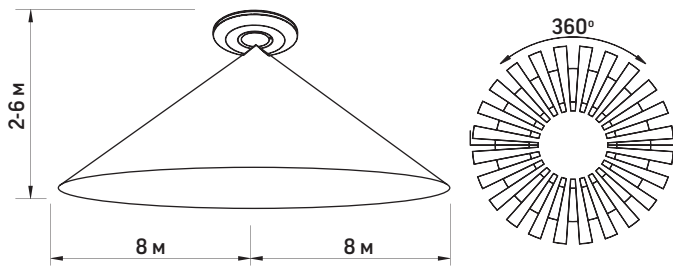

Power supply	220-240V/AC 50/60Hz
ambient light	<3-2000lux (variated)
Degree of protection	IP20
Maintaining light after leaving the detection area	Minimum 10s±3s Maximum 12m±1m
Rated load	Max. ⚡ 2000W 🔌 1000W
Detection range	360°
Detection distance	Max. 1-8m radius
High frequency system	5.8GHz continuous wave radar, ISM transmitter
Radiation power	<0.2 mW
operating temperature	-20~+50°C
Humidity	<93%RH
watt consumption	0.5W
Height of Fixture	2-6m
Detection rate	0.6-1.5m/s

## V1-ST752

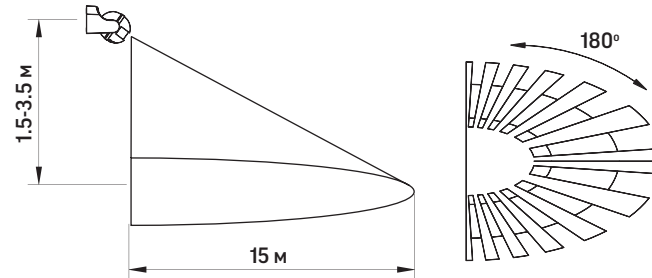

Power supply	220-240V/AC 50/60Hz
ambient light	<3-2000lux (variated)
Degree of protection	IP44
Maintaining light after leaving the detection area	Minimum 10s±3s Maximum 12m±1m
Rated load	Max. ⚡ 1200W 🔌 300W
Detection range	360°/180°
Detection distance	Max. 5-15m
High frequency system	5.8GHz continuous wave radar, ISM transmitter
Radiation power	<0.2 mW
operating temperature	-20~+50°C
watt consumption	0.9W
Height of Fixture	1.5-3.5m
Detection rate	0.6-1.5m/s

## V1-ST759B

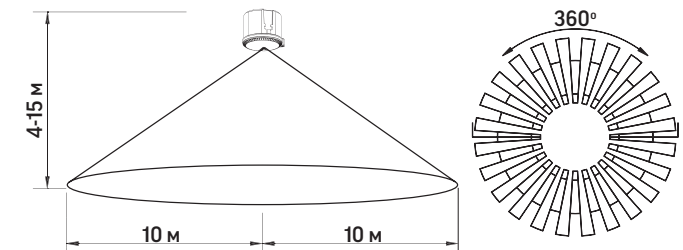

Power supply	120-277V/AC 50/60Hz
ambient light	50%, 100%
Detection range	2lux, 10lux, 50lux, 2000lux (variated)
Maintaining light after leaving the detection area	5s, 30s 90s, 3m, 5m, 10m, 20m, 30m
Low maintenance period lighting	10s, 1min, 5min, 10min, 30min, 60min, constantly, do not use dimmer
Rated load	Max. ⚡ 1200W (220-277V/AC) 800W (120V/AC) 🔌 800W (220-277V/AC) 400W (120V/AC)
Detection angle	360°
Detection distance	4-10m (variated)
High frequency system	5.8GHz continuous wave radar, ISM transmitter
Radiation power	<0.2 mW
operating temperature	-20~+50°C
watt consumption	0.9W
Detection rate	0.6-1.5m/s
Height of Fixture	1.8-2.5m
Dimming level	10%, 20%, 30%, 50%



## Technical features of lamps with microwave sensor

\*except for luminaires for Housing and utilities sector, Housing and utilities sector circle, AERO, NERO

### DEFAULT SETTINGS:

- ▶ 100% detection zone;
- ▶ When the light level is less than 50 lx and the movement is detected, the lamp turns on;
- ▶ If there is no movement for more than 90 seconds, the lamp turns off;
- ▶ At a light level of more than 50 lx lamp does not turn on

### ACTIVE ZONE OF SENSOR ACTION

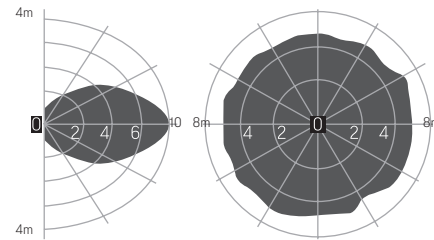

### ADDITIONAL SETTINGS:

The parameters below are adjusted using the up and down switches.

#### Detection zone

	1	2
100%	Up	Up
75%	Up	Down
50%	Down	Up
10%	Down	Down

#### Waiting time

	3	4
5 sec	Up	Up
90 sec	Up	Down
5 min	Down	Up
15 min	Down	Down

#### Illumination threshold

	5	6
Disconnect	Up	Up
50 lx	Up	Down
10 lx	Down	Up
2 lx	Down	Down

### SCHEME OF CONNECTING MULTIPLE LAMPS:

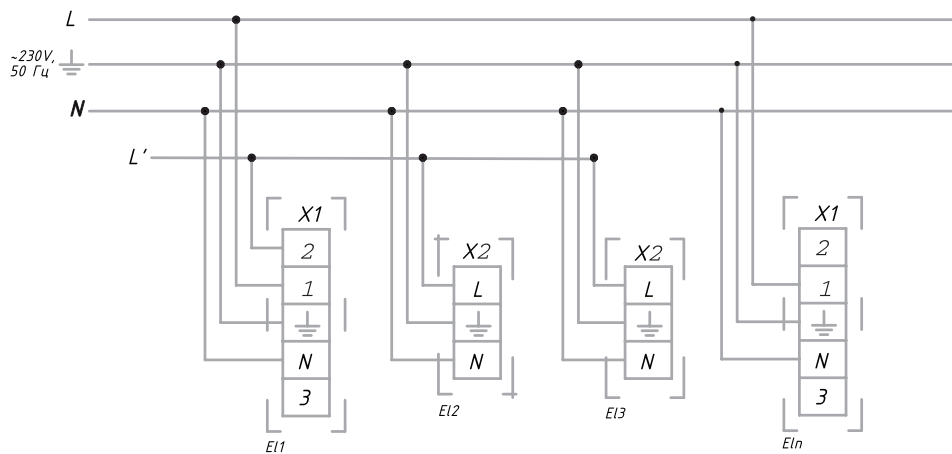

L - main phase

L' - additional phase line when connecting several lamps without a sensor (E12- E13) to luminaire with sensor (E11)



Model 203



Model 205



► Specification data of emergency power units Tridonic used in Varton luminaires

Supply voltage	220-240V
Network frequency: 50-60Hz	50-60Hz
LED module voltage:	10 - 52V (model 203) or 50 - 250V (model 205)
Emergency mode activation time	less than 0.25 sec since the detection of the emergency situations
Emergency operation time	not less than 1 hour
Ta	-5 - +55°C
Tc	+75°C
Battery life	3 years
Detection rate	0.6-1.5m/s
Time to full battery	24 hours
Battery Type	Nickel-cadmium
Battery capacity	16 Ah
Battery voltage	3.6 V (model 203) / 6.0 V (model 205)
Ta (battery)	-5 - +50°C

► LED charge indicator battery and the "Test" button are supplied in the set.

► These accessories are connected directly to the emergency power supply Tridonic unit into the connectors on the case (highlighted in red).

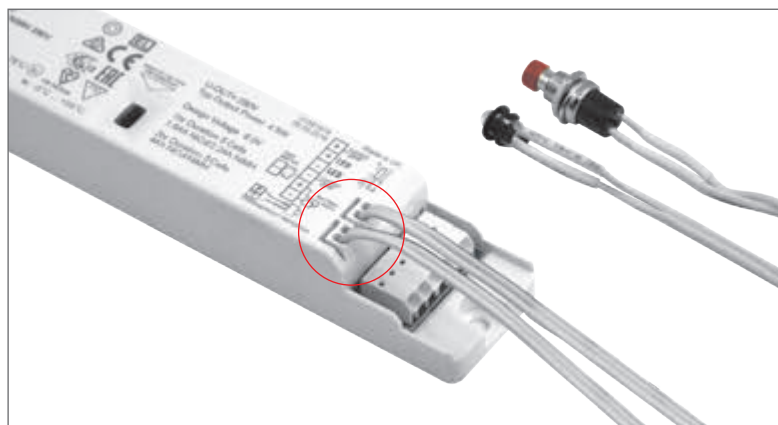

# Technical features of luminaires with emergency lighting function

## CONNECTION SCHEMES FOR LAMPS IN EMERGENCY VERSION

### ► Connection Type 1

A070/A070 IP40	S070/ S070 IP40	SL2	GR070
A070/S/A070/S IP40	S170/ S170 IP40	Ecophon Gedina D	GR070/F
A170/A170 IP40	S270/S270 IP40	MicroLook 070/350	GR070/N
A270/A270 IP40	LUX (L=1235)	Tegular 070/350	GR170/F
A300/ A300 IP40	E070/E070 IP40	Vector 070/350	GR270/F
A350/ A350 IP40	E170/ E170 IP40	Rockfon 070	
A370/A370 IP40	E350/E350 IP40		

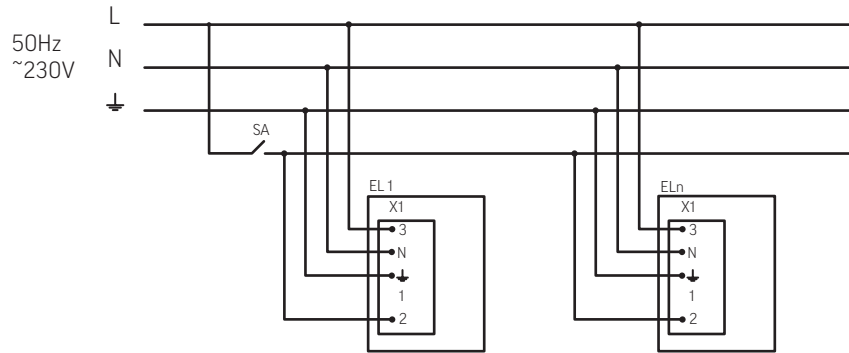

EL1-ELn - lamps, where n is the number of connected lamps

X1 - terminal strip

SA - power switch

### ► Connection Type 2

A220/A220 IP40	E270/E270 IP40	LUX (L=625)
----------------	----------------	-------------

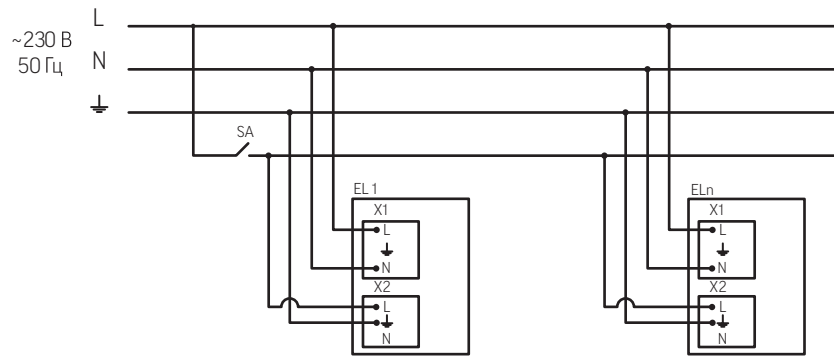

EL1-ELn - lamps, where n is the number of connected lamps

X1- terminal strip located further from the power source, X2 - terminal strip located closer to the power source

SA - power switch.

### ► Connection Type 3

C070	C270	AL170	Clip-In 350 IP54
C070/GL	C270/N	AL270	Clip-In 070 IP54
C070/N	C350	Iron	Clip-In 070 IP40
C070/NGL	C350/N	Iron Opal	Cesal 070 IP40
C170/C170/GL	A070/OT	Iron Agro	Cesal 070 IP54
C170/N			

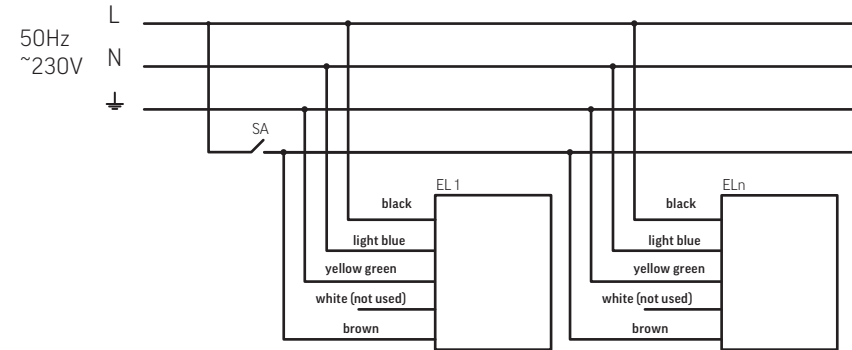

EL1-ELn - lamps, where n is the number of connected lamps

SA - power switch

### ► Connection Type 4

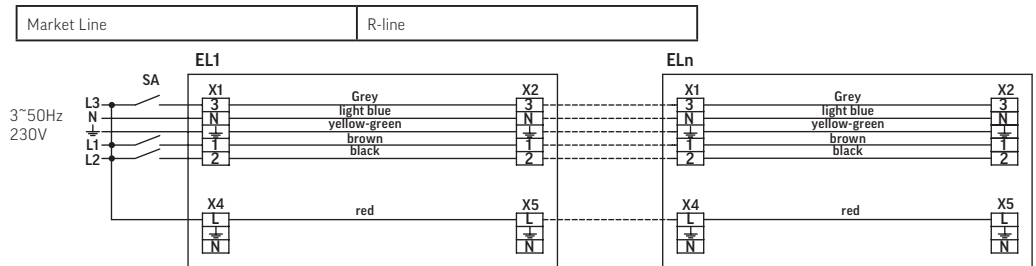

EL1-ELn - lamps, where n is the number of connected lamps

SA - power switch, X1, X2, X4, X5 - terminal strips

With any type of connection the lamp has three operation modes:

1. Operating mode

Depending on the type of connection, the phase is present:

- on pins 2 and 3 of terminal block X1 (connection type 1)

- on contacts L of terminal strips X1 and X2 (connection type 2)

- on the red and brown wire (connection type 3)

- on pin 3 of terminal strips X1 and X2 (power supply by default

entered into phase L3) and contact L of terminal blocks X4 and X5 (type

connect 4)

at the same time all LED modules of the lamp give out 100%

light flux.

2. Emergency mode

Depending on the type of connection, there is no phase:

- on pins 2 and 3 of terminal block X1 (connection type 1)

- on contact L of terminal strips X1 and X2 (connection type 2)

- on the red and brown wire (connection type 3)

- on pin 3 of terminal strips X1 and X2 (power supply by default

entered into phase L3) and contact L of terminal blocks X4 and X5 (type connections 4), while all the LED modules of the lamp provide 10% of the luminous flux of nominal.

3. Battery charging mode

Depending on the type of connection:

- the phase on pin 2 is missing, the phase on pin 3 is present on the X1

terminal block (connection type 1)

- there is no phase on pin L of terminal strip X2, a phase on pin L of

terminal strip X1 is present (connection type 2)

- there is no phase on the brown wire, a phase on the red wire is present

(connection type 3)

- the phase on pin 3 of the terminal blocks X1 and X2 (by default, power

is applied to the phase L3) is absent, the phase on pin L

X4 and X5 terminal blocks are present (connection type 4), while the

LED modules do not glow and the battery is charged.





**SOURCES OF LIGHT**



# HIGH-POWER LAMP

## Dimensions

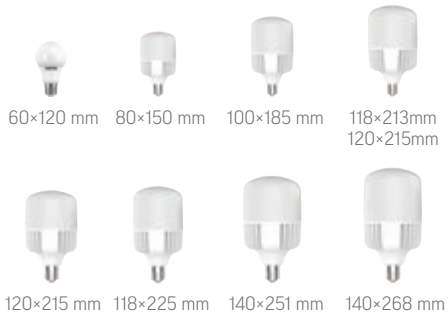

## Voltage

**230V**

## Power

**15W   50W**  
**20W   70W**  
**30W   90W**  
**40W**

## Base

**E27   E40**

## Light temperature

4000K  
Neutral white  
 6500K  
Cold white



# LOCAL LIGHTING LAMP

## Dimensions



## Voltage

**12V   24-36V   127V**

## Power

**7W   12W**

## Base

**E27**

## Light temperature

4000K  
Neutral white



**Body:**

Glass / plastic

**Specifications:**

G13 base

Index of color transmission Ra &gt; 82

Light beam angle 220 °

Pulsation level &lt;5%

Temperature range from + 1 ° C to + 40 ° C

Network frequency 50Hz ± 10%

LED life 25,000 hours

1 year warranty

**LED T8**

600×28mm

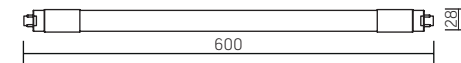

AC220-240V

**EAC**

○ white

Article	Base	Power	Light temperature	Luminous flux
VRT6000940	G13	9,5W	4000K	900lm

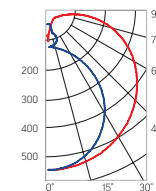

## High-Power Lamps

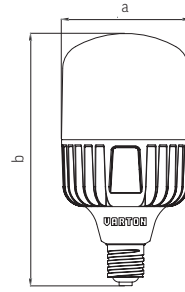

220V AC



○ white

Article	Base	Analog	Power	Light temperature	Luminous flux	Size (a×b)
V15011	E27	150W	15W	4000K	1350lm	60×120mm
V20012	E27	200W	20W	4000K	1900lm	80×150mm
V30013	E27	300W	30W	4000K	2600lm	100×185mm
V40016	E27	400W	40W	4000K	3600lm	118×213mm
V40017	E40	400W	40W	4000K	3600lm	118×225mm
V50014	E27	550W	50W	4000K	4200lm	120×215mm
V50015	E40	550W	50W	4000K	4200lm	120×215mm
V70016	E40	700W	70W	4000K	6400lm	140×251mm
V70017	E40	700W	70W	6500K	6400lm	140×251mm
V90016	E40	900W	90W	4000K	8200lm	140×268mm
V90017	E40	900W	90W	6500K	8200lm	140×268mm

### Body Material:

Aluminum / plastic

### Application:

It is used for local, industrial and warehouse lighting; it is a replacement for LON, DRV and CFL lamps

### Specifications:

E27 / E40 base

Index of color transmission Ra > 80

Temperature range from -20 ° C to + 40 ° C

Network frequency 50Hz ± 10%

LED lifetime 30,000 hours

1 year warranty





# LED lamps for local lighting (12V, 24-36V, 127V)

60x110mm / 60x125mm



## Body:

A60 lamp

## Application:

It is used for local illumination of working areas, equipment and machine tools in workshops at production sites, as well as on ships and construction sites.

## Specifications:

E27 base  
 Index of color transmission Ra > 80  
 Pulsation level <1%  
 Temperature range from +1 °C to +40 °C  
 Network frequency 50Hz ± 10%  
 LED lifetime 30,000 hours  
 1 year warranty

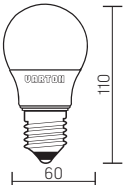
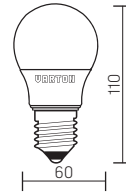
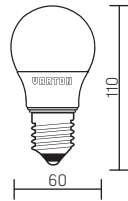

Article	Analog	Power	Light temperature	Luminous flux
902502270	70W	7W	4000K	600lm



12V AC/DC  
 Lamp size:  
 60x110mm  
 white



Article	Analog	Power	Light temperature	Luminous flux
902502265	60W	6,5W	4000K	550lm



24-36V AC/DC  
 Lamp size:  
 60x110mm  
 white



Article	Analog	Power	Light temperature	Luminous flux
902502470	70W	7W	4000K	600lm

127V AC  
 Lamp size:  
 60x110mm  
 white

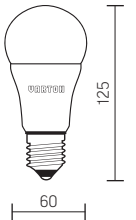
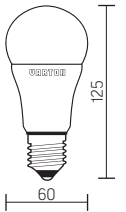
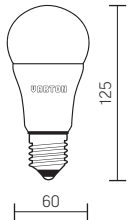

Article	Analog	Power	Light temperature	Luminous flux
902502312	100W	12W	4000K	1000lm

12V AC/DC  
 Lamp size:  
 60x125mm  
 white



Article	Analog	Power	Light temperature	Luminous flux
902502212	100W	12W	4000K	1000lm

24-36V AC/DC  
 Lamp size:  
 60x125mm  
 white



Article	Analog	Power	Light temperature	Luminous flux
902502412	100W	12W	4000K	1000lm

127V AC  
 Lamp size:  
 60x125mm  
 white



**AGRO LIGHTING**



## Iron Agro

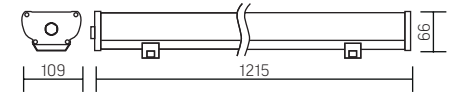

Lamp Size: 1215x109x66mm  
 AC176-264V  
 Package size of the lamp:  
 1293x117x72mm  
 PF ≥ 0,97



NEW MODEL

Article	Power	Light temperature	Luminous flux
V1-IA-70072-03000-6703640	36W	4000K	4000lm
V1-IA-70072-03000-6703650	36W	5000K	4000lm
V1-IA-70072-03000-6703665	36W	6500K	4100lm
V1-IA-70072-03000-6705440	54W	4000K	6100lm
V1-IA-70072-03000-6705450	54W	5000K	6100lm
V1-IA-70072-03000-6705465	54W	6500K	6300lm

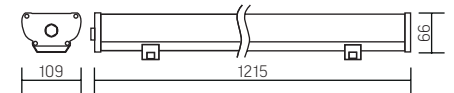
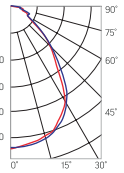

### **A** Autonomous emergency lamp permanent action

Emergency power supply unit, battery for 1 hour of autonomous operation, charge indicator, "Test" button in the set (see description on page 266)

**Conformity:**  
 GOST IEC 60598-2-22-2012 "Luminaries. Part 2-22.  
 Private requirements. Luminaries for emergency lighting "SP 52. 13330. 2011" Natural and artificial lighting "(updated edition of SNiP 23.05-95)

NEW MODEL

Article	Power	Light temperature	Luminous flux
V1-IA-70072-03A00-6703640	36W	4000K	4000lm
V1-IA-70072-03A00-6703650	36W	5000K	4000lm
V1-IA-70072-03A00-6703665	36W	6500K	4100lm
V1-IA-70072-03A00-6705440	54W	4000K	6100lm
V1-IA-70072-03A00-6705450	54W	5000K	6100lm
V1-IA-70072-03A00-6705465	54W	6500K	6300lm

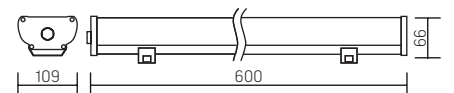
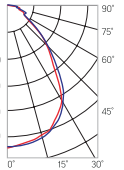

Lamp Size: 600x109x66mm  
 AC176-264V  
 Package size of the lamp:  
 646x117x72mm  
 PF ≥ 0,97



NEW MODEL

Article	Power	Light temperature	Luminous flux
V1-IA-70073-03000-6701840	18W	4000K	2100lm
V1-IA-70073-03000-6701850	18W	5000K	2100lm
V1-IA-70073-03000-6701865	18W	6500K	2200lm
V1-IA-70073-03000-6702740	27W	4000K	3000lm
V1-IA-70073-03000-6702750	27W	5000K	3000lm
V1-IA-70073-03000-6702765	27W	6500K	3100lm

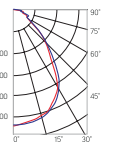

### Installation:

It is mounted both on a flat surface, and on suspensions  
 Easy installation and connection due to the wires removed from the lamp housing

### Case:

Aluminum anodized body  
 Diffuser transparent PMMA (acrylic), resistant to UV radiation and exposure to specific media in agriculture  
 Special silicone pads to ensure compliance with IP67 protection class

### Application:

For lighting livestock and poultry complexes  
 Industrial premises with high illumination requirements

### Specifications:

Index of color transmission Ra > 80  
 Temperature range from -40 °C to + 45 °C  
 LED life 50,000 hours  
 3 year warranty  
 Luminous flux Kn ≤ 1%





**PHYTO LIGHTING**

## Iron PHYTO 0.9m

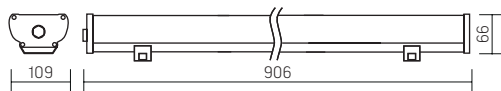

Lamp size: 906x109x66mm  
AC176-264V  
Package size of the lamp:  
965x113x70mm  
PF ≥ 0,97



○ metal

Article	Power	PPF, $\mu\text{mol} / \text{s}$
---------	-------	---------------------------------

V1-IA-70157-03000-67044RB	44	90
---------------------------	----	----

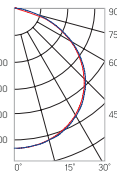
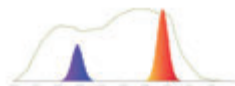

## Iron PHYTO 1.2m

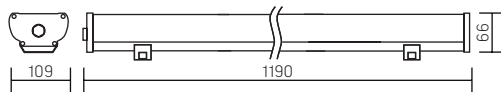

Lamp size: 1190x109x66mm  
AC176-264V  
Package size of the lamp:  
1293x117x70mm  
PF ≥ 0,97



○ metal

Article	Power	PPF, $\mu\text{mol} / \text{s}$
---------	-------	---------------------------------

V1-IA-70156-03000-67060RB	60	120
---------------------------	----	-----

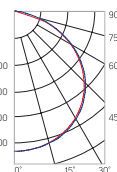
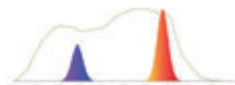

## Iron PHYTO 1.5m

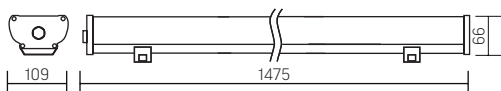

Lamp size: 1475x109x66mm  
AC176-264V  
Package size of the lamp:  
1475x119x70mm  
PF ≥ 0,97



○ metal

Article	Power	PPF, $\mu\text{mol} / \text{s}$
---------	-------	---------------------------------

V1-IA-70155-03000-67070RB	70	151
---------------------------	----	-----

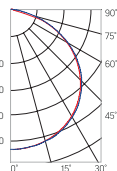

### Application:

For lighting greenhouses

### Installation:

Mounted both on a flat surface, and on suspensions.

Easy installation and connection due to the wires removed from the luminaire

### Body:

Aluminum anodized body.

Diffuser transparent PMMA (acrylic)

### Specifications:

Temperature mode:  $-40^{\circ}\text{C}$  to  $+45^{\circ}\text{C}$

LED life 50,000 hours

3 year warranty

Light flux:  $\text{Kn} \leq 1$



## Iron Lens PHYTO, 0.9ml

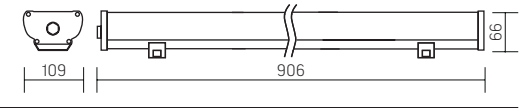

Lamp Size:  
906x109x66 mm  
AC176-264V  
Package size of the lamp:  
965x113x70mm  
PF ≥ 0,97



Article	Power	PPF, $\mu\text{mol} / \text{s}$
V1-IA-70157-03L12-67044RB	44	84

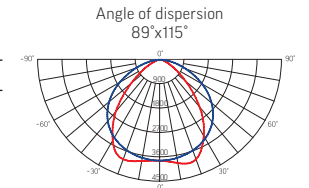
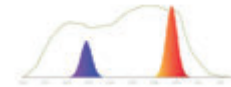

Article	Power	PPF, $\mu\text{mol} / \text{s}$
V1-IA-70157-03L13-67044RB	44	84

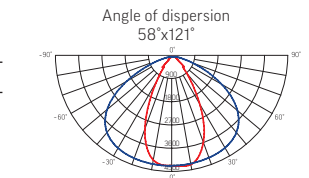
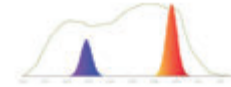

Article	Power	PPF, $\mu\text{mol} / \text{s}$
V1-IA-70157-03L14-67044RB	44	84

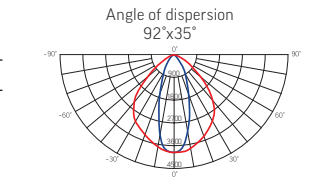
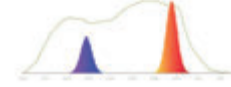

Article	Power	PPF, $\mu\text{mol} / \text{s}$
V1-IA-70157-03L15-67044RB	44	84

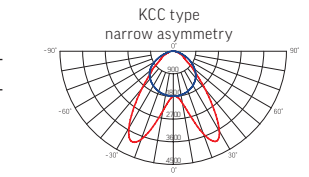
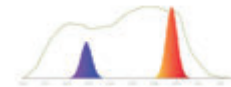

Article	Power	PPF, $\mu\text{mol} / \text{s}$
V1-IA-70157-03L16-67044RB	44	84

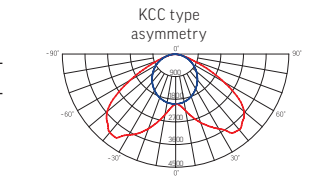

Article	Power	PPF, $\mu\text{mol} / \text{s}$
V1-IA-70157-03L17-67044RB	44	84

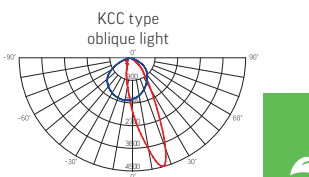

### Application:

For lighting greenhouses

### Installation:

Mounted both on a flat surface, and on suspensions.  
Easy installation and connection due to the wires removed from the luminaire

### Case:

Aluminum anodized body.  
Diffuser transparent PMMA (acrylic)

### Specifications:

Temperature mode: -40 ° C to + 45 ° C  
LED life 50,000 hours  
3 year warranty  
Light flux: Kn ≤1



## Iron Lens PHYTO, 1.2m

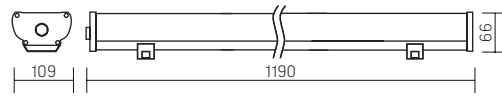

Lamp Size:  
1190x109x66mm  
AC176-264V  
Package size of the lamp:  
1293x117x70mm  
PF ≥ 0,97



Article	Power	PPF, $\mu\text{mol} / \text{s}$	Angle of dispersion
V1-IA-70156-03L12-67060RB	60	112	89°x115°
Article	Power	PPF, $\mu\text{mol} / \text{s}$	Angle of dispersion
V1-IA-70156-03L13-67060RB	60	112	58°x121°
Article	Power	PPF, $\mu\text{mol} / \text{s}$	Angle of dispersion
V1-IA-70156-03L14-67060RB	60	112	92°x35°
Article	Power	PPF, $\mu\text{mol} / \text{s}$	KCC type narrow asymmetry
V1-IA-70156-03L15-67060RB	60	112	
Article	Power	PPF, $\mu\text{mol} / \text{s}$	KCC type narrow asymmetry
V1-IA-70156-03L16-67060RB	60	112	
Article	Power	PPF, $\mu\text{mol} / \text{s}$	KCC type narrow asymmetry
V1-IA-70156-03L17-67060RB	60	112	

## Iron Lens PHYTO, 1.5m

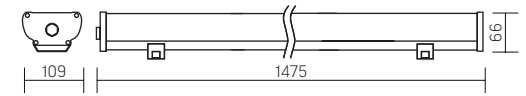

Lamp Size:  
1475x109x66mm  
AC176-264V  
Package size of the lamp:  
1475x119x70mm  
PF ≥ 0,97



Article	Power	PPF, $\mu\text{mol} / \text{s}$	Angle of dispersion
V1-IA-70155-03L12-67070RB	70	140	89°x115°
Article	Power	PPF, $\mu\text{mol} / \text{s}$	Angle of dispersion
V1-IA-70155-03L13-67070RB	70	140	58°x121°
Article	Power	PPF, $\mu\text{mol} / \text{s}$	Angle of dispersion
V1-IA-70155-03L14-67070RB	70	140	92°x35°
Article	Power	PPF, $\mu\text{mol} / \text{s}$	KCC type narrow asymmetry
V1-IA-70155-03L15-67070RB	70	140	
Article	Power	PPF, $\mu\text{mol} / \text{s}$	KCC type asymmetry
V1-IA-70155-03L16-67070RB	70	140	
Article	Power	PPF, $\mu\text{mol} / \text{s}$	KCC type oblique light
V1-IA-70155-03L17-67070RB	70	140	





**Application.**

For lighting greenhouses

**Installation:**

Fastening on walls, ceiling and floor with the ability to adjust the angle of inclination within 180 °

**Case:**

Aluminum anodized body

**Secondary optics:**

To protect the LEDs used secondary optics made of acrylic, resistant to physical and chemical influences

**Specifications:**

Photosynthetic flow: 97-514 μmol / s

Operating temperature: -40 ° C to + 45 ° C

AC100-305 V, 47-63 Hz, DC142-431 V

LED life 50,000 hours

Luminous flux ≤1%

3 year warranty

**Olymp PHYTO**

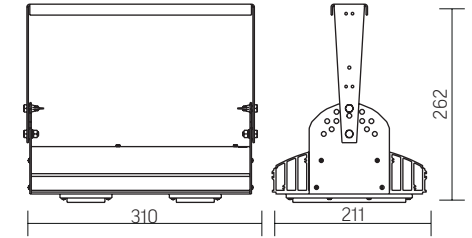

Angle of rotation – 180°  
Lamp Size:  
310×211×262mm  
Package size of the lamp:  
400×310×150mm  
PF ≥ 0,97



Article	Power	PPF, μmol/s	Angle of dispersion
V1-I2-70076-04L10-65045RB	45W	97	12°
V1-I2-70076-04L09-65045RB	45W	97	19°
V1-I2-70076-04L07-65045RB	45W	97	60°
V1-I2-70076-04L06-65045RB	45W	97	90°
V1-I2-70076-04L08-65045RB	45W	97	30°x110°
V1-I2-70076-04L05-65045RB	45W	97	120°

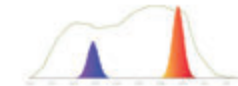
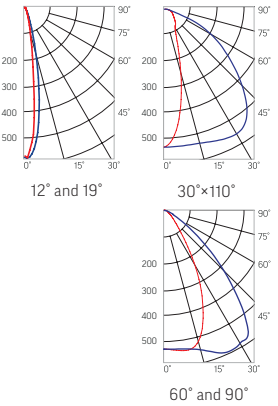

**Olymp PHYTO Premium**

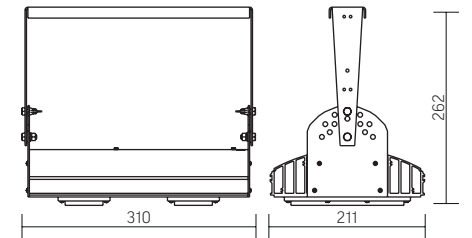

Angle of rotation – 180°  
Lamp Size:  
310×211×262mm  
Package size of the lamp:  
400×310×150mm  
PF ≥ 0,97



Article	Power	PPF, μmol/s	Angle of dispersion
V1-I2-70076-04L10-6505040	50W	103	12°
V1-I2-70076-04L09-6505040	50W	103	19°
V1-I2-70076-04L07-6505040	50W	103	60°
V1-I2-70076-04L06-6505040	50W	103	90°
V1-I2-70076-04L08-6505040	50W	103	30°x110°
V1-I2-70076-04L05-6505040	50W	103	120°

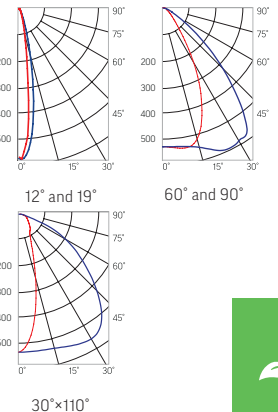



## Olymp PHYTO

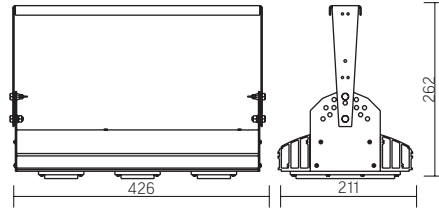

Angle of rotation – 180°  
Lamp Size:  
426×211×262mm  
Package size of the lamp:  
480×310×150mm  
PF ≥ 0,97

Article	Power	PPF, μmol/s	Angle of dispersion
V1-I2-70077-04L10-65065RB	65W	145	12°
V1-I2-70077-04L09-65065RB	65W	145	19°
V1-I2-70077-04L07-65065RB	65W	145	60°
V1-I2-70077-04L06-65065RB	65W	145	90°
V1-I2-70077-04L08-65065RB	65W	145	30°×110°
V1-I2-70077-04L05-65065RB	65W	145	120°

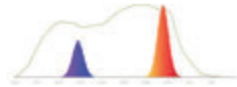
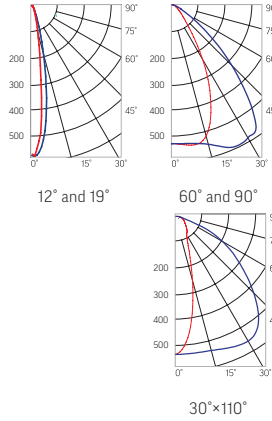

## Olymp PHYTO

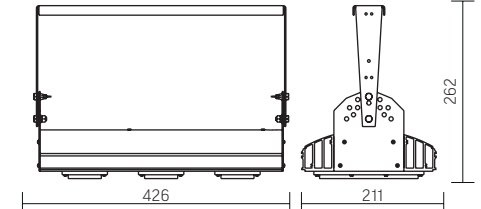

Angle of rotation – 180°  
Lamp Size:  
426×211×262mm  
Package size of the lamp:  
480×310×150mm  
PF ≥ 0,97

Article	Power	PPF, μmol/s	Angle of dispersion
V1-I2-70077-04L10-65090RB	90W	194	12°
V1-I2-70077-04L09-65090RB	90W	194	19°
V1-I2-70077-04L07-65090RB	90W	194	60°
V1-I2-70077-04L06-65090RB	90W	194	90°
V1-I2-70077-04L08-65090RB	90W	194	30°×110°
V1-I2-70077-04L05-65090RB	90W	194	120°

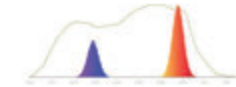
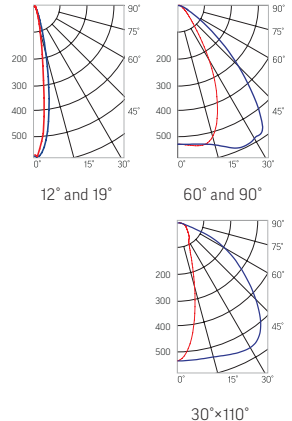

## Olymp PHYTO Premium

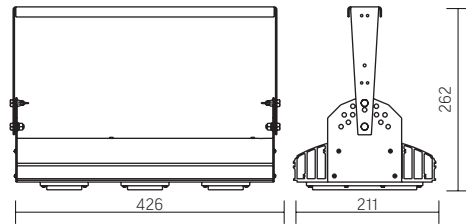

Angle of rotation – 180°  
Lamp Size:  
426×211×262mm  
Package size of the lamp:  
480×310×150mm  
PF ≥ 0,97

Article	Power	PPF, μmol/s	Angle of dispersion
V1-I2-70077-04L10-6506540	65W	145	12°
V1-I2-70077-04L09-6506540	65W	145	19°
V1-I2-70077-04L07-6506540	65W	145	60°
V1-I2-70077-04L06-6506540	65W	145	90°
V1-I2-70077-04L08-6506540	65W	145	30°×110°
V1-I2-70077-04L05-6506540	65W	145	120°

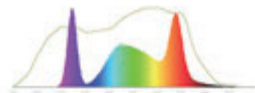
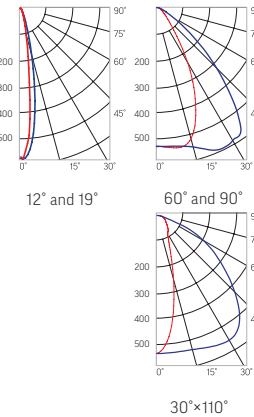

## Olymp PHYTO Premium

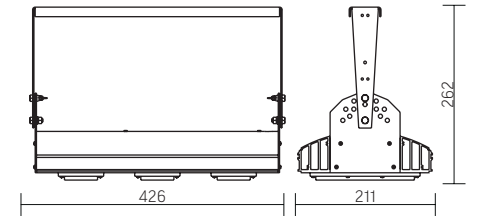

Angle of rotation – 180°  
Lamp Size:  
426 211×262mm  
Package size of the lamp:  
480×310×150mm  
PF ≥ 0,97

Article	Power	PPF, μmol/s	Angle of dispersion
V1-I2-70077-04L10-6510040	100W	206	12°
V1-I2-70077-04L09-6510040	100W	206	19°
V1-I2-70077-04L07-6510040	100W	206	60°
V1-I2-70077-04L06-6510040	100W	206	90°
V1-I2-70077-04L08-6510040	100W	206	30°×110°
V1-I2-70077-04L05-6510040	100W	206	120°

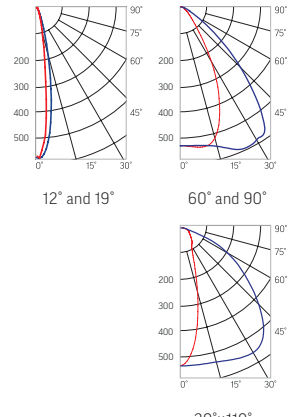

## Olymp PHYTO

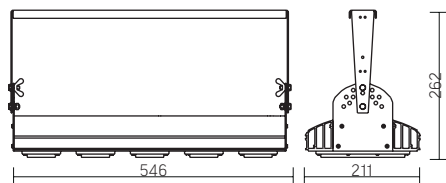

Angle of rotation – 180°  
Lamp Size:  
546×211×262mm  
Package size of the lamp:  
595×310×150mm  
PF ≥ 0,97



Article	Power	PPF, μmol/s	Angle of dispersion
V1-I2-70077-04L10-6510040	110W	242	12°
V1-I2-70077-04L09-6510040	110W	242	19°
V1-I2-70078-04L07-65110RB	110W	242	60°
V1-I2-70078-04L06-65110RB	110W	242	90°
V1-I2-70078-04L08-65110RB	110W	242	30°×110°
V1-I2-70078-04L05-65110RB	110W	242	120°

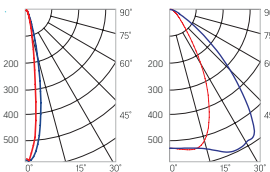

12° and 19°

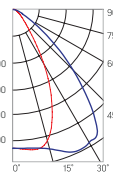

60° and 90°

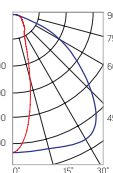

30°×110°

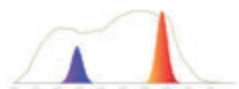

## Olymp PHYTO Premium

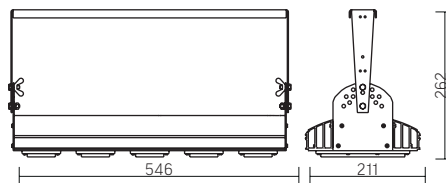

Angle of rotation – 180°  
Lamp Size:  
546×211×262mm  
Package size of the lamp:  
595×310×150mm  
PF ≥ 0,97



Article	Power	PPF, μmol/s	Angle of dispersion
V1-I2-70077-04L10-6510040	125W	257	12°
V1-I2-70077-04L09-6510040	125W	257	19°
V1-I2-70078-04L07-6512540	125W	257	60°
V1-I2-70078-04L06-6512540	125W	257	90°
V1-I2-70078-04L08-6512540	125W	257	30°×110°
V1-I2-70078-04L05-6512540	125W	257	120°

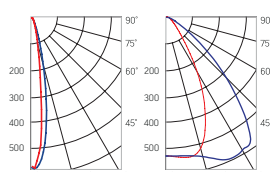

12° and 19°

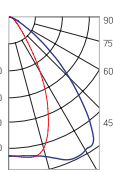

60° and 90°

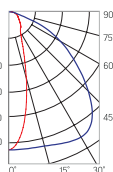

30°×110°



## Olymp PHYTO

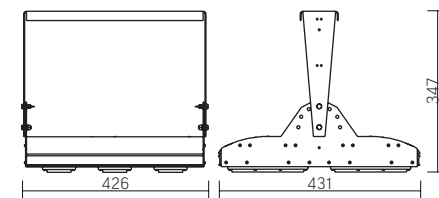
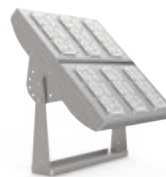

Angle of rotation – 180°  
Lamp Size:  
426×431×347mm  
Package size of the lamp:  
476×481×252mm  
PF ≥ 0,97



Article	Power	PPF, μmol/s	Angle of dispersion
V1-I2-70096-04L10-65130RB	130W	291	12°
V1-I2-70096-04L09-65130RB	130W	291	19°
V1-I2-70096-04L07-65130RB	130W	291	60°
V1-I2-70096-04L06-65130RB	130W	291	90°
V1-I2-70096-04L08-65130RB	130W	291	30°×110°
V1-I2-70096-04L05-65130RB	130W	291	120°

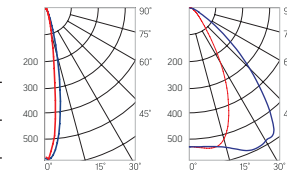

12° and 19°

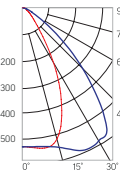

60° and 90°

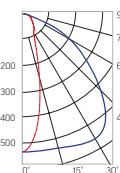

30°×110°

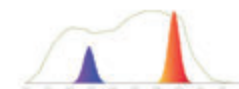

## Olymp PHYTO Premium

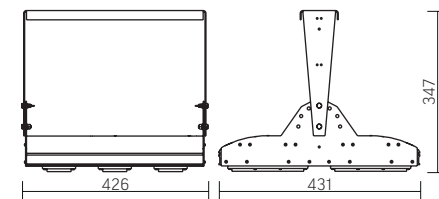
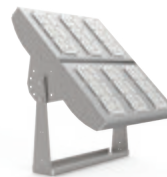

Angle of rotation – 180°  
Lamp Size:  
426×431×347mm  
Package size of the lamp:  
476×481×252mm  
PF ≥ 0,97



Article	Power	PPF, μmol/s	Angle of dispersion
V1-I2-70096-04L10-6515040	150W	308	12°
V1-I2-70096-04L09-6515040	150W	308	19°
V1-I2-70096-04L07-6515040	150W	308	60°
V1-I2-70096-04L06-6515040	150W	308	90°
V1-I2-70096-04L08-6515040	150W	308	30°×110°
V1-I2-70096-04L05-6515040	150W	308	120°

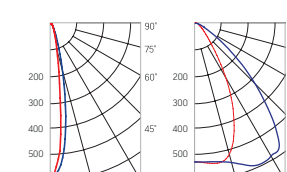

12° and 19°

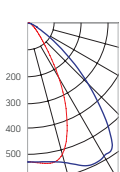

60° and 90°

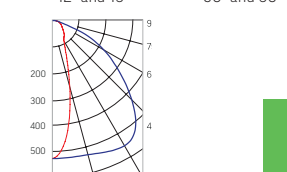

30°×110°



## Olymp PHYTO

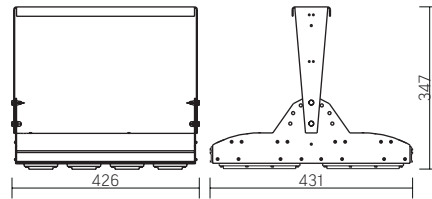

Angle of rotation – 180°  
Lamp Size:  
426×431×347mm  
Package size of the lamp:  
476×481×252mm  
PF ≥ 0,97

Article	Power	PPF, μmol/s	Angle of dispersion
V1-I2-70096-04L10-65180RB	180W	388	12°
V1-I2-70096-04L09-65180RB	180W	388	19°
V1-I2-70096-04L07-65180RB	180W	388	60°
V1-I2-70096-04L06-65180RB	180W	388	90°
V1-I2-70096-04L08-65180RB	180W	388	30°×110°
V1-I2-70096-04L05-65180RB	180W	388	120°

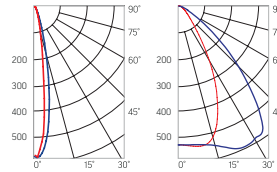

12° and 19°

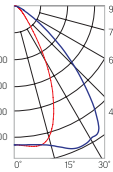

60° and 90°

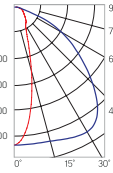

30°×110°

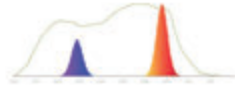

○ metal

## Olymp PHYTO Premium

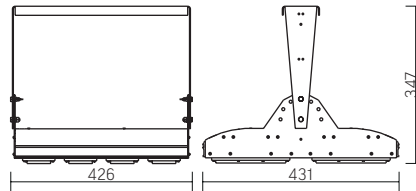

Angle of rotation – 180°  
Lamp Size:  
310×211×262mm  
Package size of the lamp:  
400×310×150mm  
PF ≥ 0,97

Article	Power	PPF, μmol/s	Angle of dispersion
V1-I2-70096-04L10-6520040	200W	411	12°
V1-I2-70096-04L09-6520040	200W	411	19°
V1-I2-70096-04L07-6520040	200W	411	60°
V1-I2-70096-04L06-6520040	200W	411	90°
V1-I2-70096-04L08-6520040	200W	411	30°×110°
V1-I2-70096-04L05-6520040	200W	411	120°

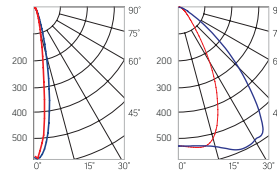

12° and 19°

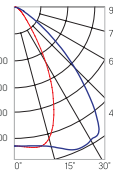

60° and 90°

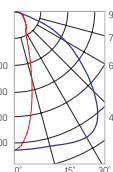

30°×110°



○ metal

## Olymp PHYTO

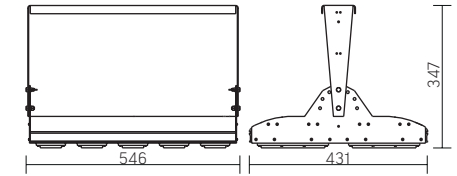

Angle of rotation – 180°  
Lamp Size:  
546×431×347mm  
Package size of the lamp:  
620×567×252mm  
PF ≥ 0,97

Article	Power	PPF, μmol/s	Angle of dispersion
V1-I2-70097-04L10-65220RB	220W	485	12°
V1-I2-70097-04L09-65220RB	220W	485	19°
V1-I2-70097-04L07-65220RB	220W	485	60°
V1-I2-70097-04L06-65220RB	220W	485	90°
V1-I2-70097-04L08-65220RB	220W	485	30°×110°
V1-I2-70097-04L05-65220RB	220W	485	120°

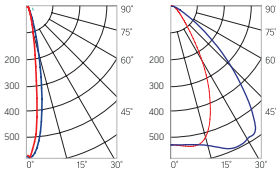

12° and 19°

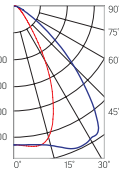

60° and 90°

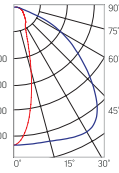

30°×110°

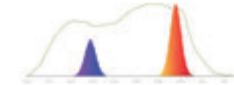

○ metal

## Olymp PHYTO Premium

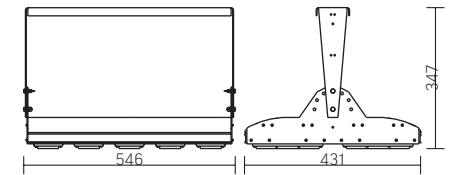

Angle of rotation – 180°  
Lamp Size:  
546×431×347mm  
Package size of the lamp:  
620×567×252mm  
PF ≥ 0,97

Article	Power	PPF, μmol/s	Angle of dispersion
V1-I2-70097-04L10-6525040	250W	514	12°
V1-I2-70097-04L09-6525040	250W	514	19°
V1-I2-70097-04L07-6525040	250W	514	60°
V1-I2-70097-04L06-6525040	250W	514	90°
V1-I2-70097-04L08-6525040	250W	514	30°×110°
V1-I2-70097-04L05-6525040	250W	514	120°

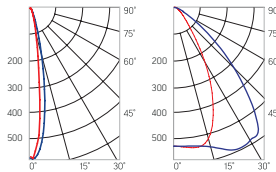

12° and 19°

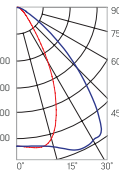

60° and 90°

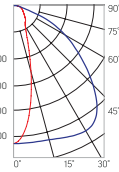

30°×110°



○ metal





## Project Opportunities

The Varton Group of Companies carries out project activities in various areas:

- ▶ development of the lighting concept;
- ▶ participation in the development of draft design;
- ▶ calculation of illumination on objects;
- ▶ participation in the preparation and implementation of the working draft;
- ▶ development of a comprehensive lighting project;
- ▶ consultation in the application of lighting.

GC "Varton" has considerable experience in the preparation and implementation of lighting projects of various levels of complexity at outdoor lighting facilities, highways and park areas, shopping and entertainment complexes, car dealerships, housing and public utilities facilities, industrial and warehouse buildings, sports and educational institutions and etc.

In the course of its activities, the Varton Group of Companies relies on the Federal Law No. 184-F3 of December 27, 2002 – On Technical Regulation (as amended on July 28, 2012, with amendments that entered into force on July 30, 2012). The projects use lighting equipment of its own production, which is subject to mandatory and voluntary certification in Russia. Products "Varton" successfully passed the environmental test and, according to experts, has a high level of safety and a certificate of "Eco-seal" for reconstructed buildings.

Lighting reorganization at the facilities is carried out in accordance with Federal Law No. 261-F3 of 11.11.2009 – On Energy Saving and Energy Efficiency Improvement and on Amendments to separate legislative acts of the Russian Federation ". GC "Varton" produces and delivers energy-saving LED equipment, the use of which reduces energy consumption at the facilities, without affecting the general characteristics of illumination and in some cases improving the quality of lighting.

Specialists of the Varton Group of Companies accompany projects at all stages of work: from preliminary studies and lighting calculations to the stage of installation supervision. The work is based on accurate calculations for a particular room. Calculations are carried out in accordance with the legal and medical standards for illumination, features of the building, its purpose and customer requirements.

Technical and software bases allow solving problems of equipping both buildings under construction and reconstructed buildings.

In both cases, computer simulations, creating layouts and 3D visualizations of objects are used with the help of which the algorithm for constructing a project becomes more clear for the contractor and the customer. When working with newly erected buildings, the client provides the necessary drawings of the premises, architectural models and floor plans. During the reconstruction of the premises, the specialists of the project department, if necessary, travel to the object for examination, calculate the illumination and draw up a list of recommendations on equipment, on the basis of which the future project is created.



1  
IP65 Strong  
Manufacturing facility



2  
A070  
Office



3  
Triumph  
Parking zone



4  
Olymp  
Warehouse



5  
Housing and utilities sector -  
Flight of stairs



6  
Iron  
Assembly area

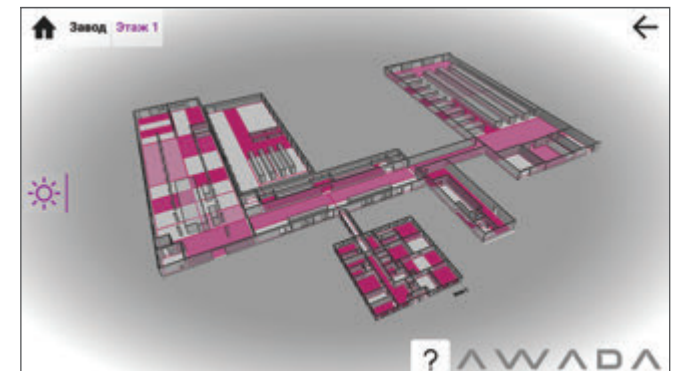
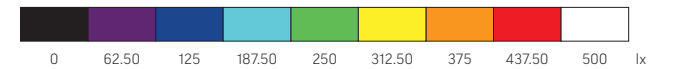
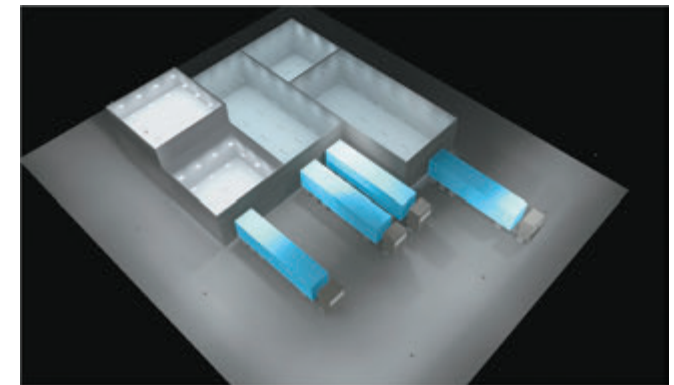
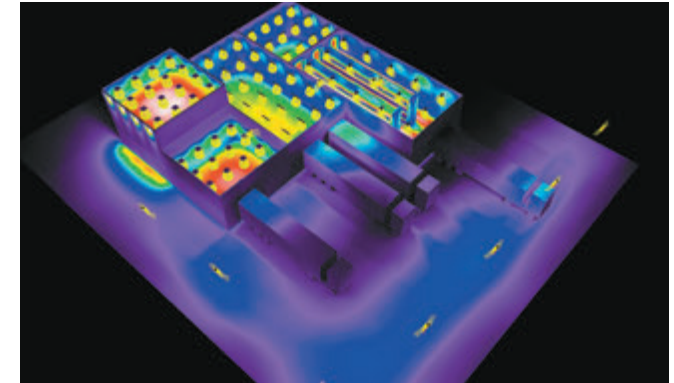
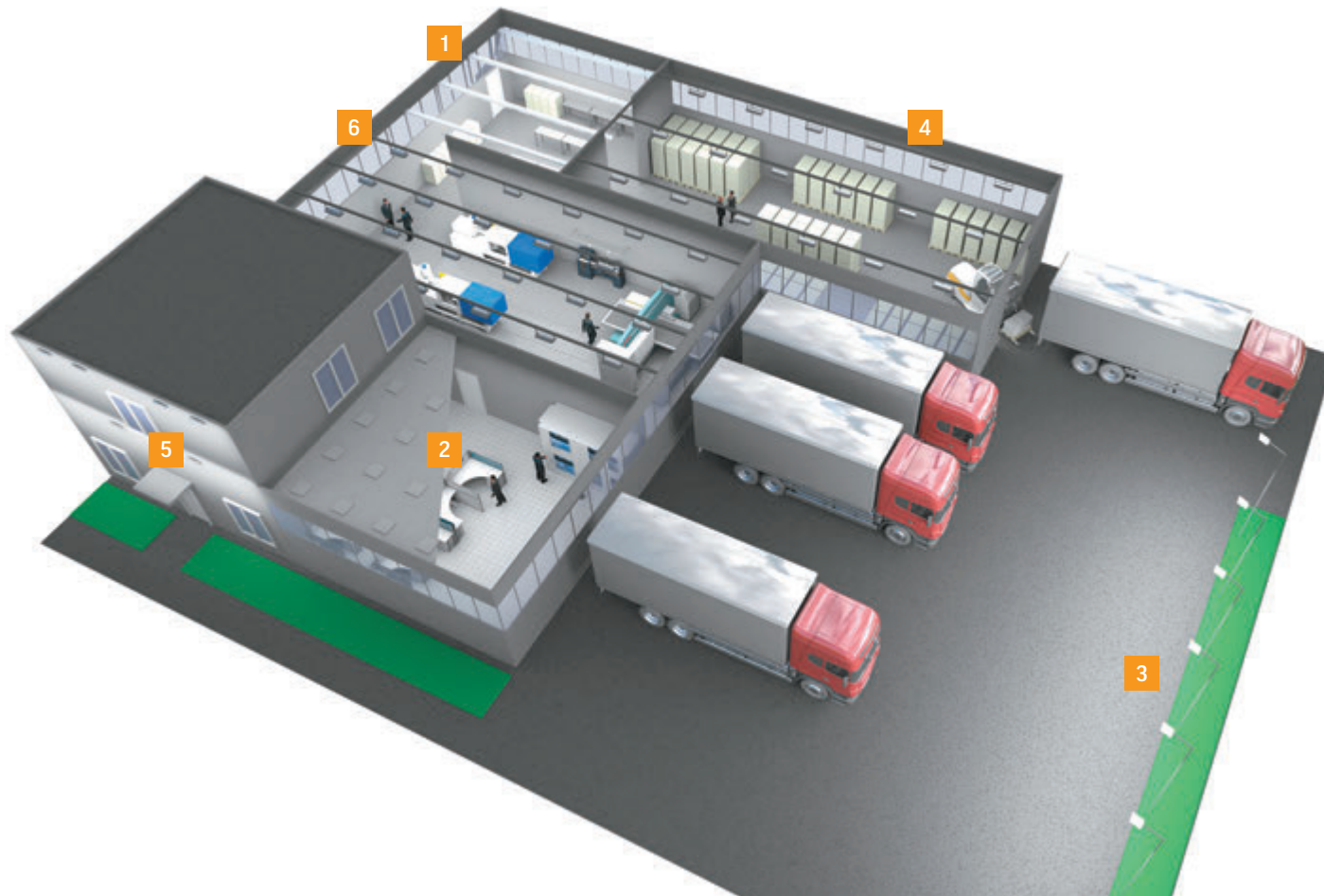

1  
IP65 Strong  
Manufacturing facility



2  
A070  
Office



3  
Triumph  
Parking zone



4  
Olymp  
Warehouse



5  
Housing and utilities  
sector - Flight of stairs



6  
Iron  
Assembly area

## Diffusers for luminaries

For luminaires equipped with different types of diffusers, the luminous flux is specified without taking into account the light transmission of the diffusers

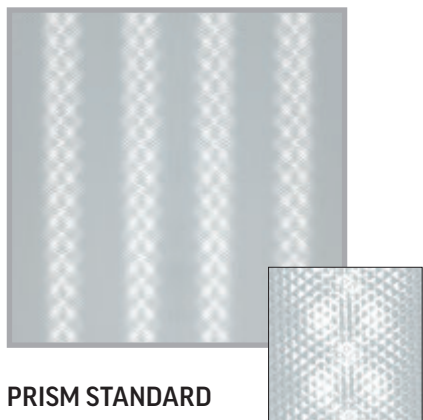

**PRISM STANDARD**

2.5mm thickness  
Light transmission 90%  
Material: polystyrene  
Scale 1:1

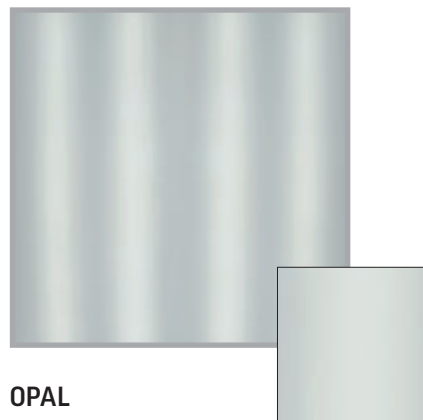

**OPAL**

1.5mm thickness  
Light transmission 76%  
Material: PMMA  
Scale 1:1

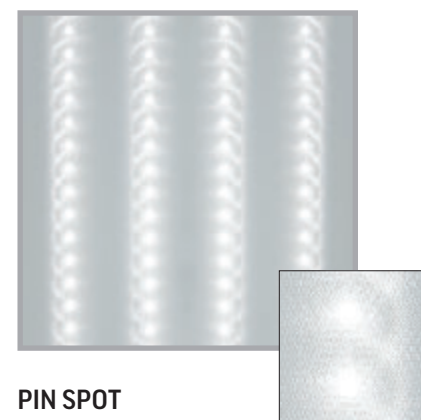

**PIN SPOT**

2.0mm thickness  
Light transmission 88%  
Material: polystyrene  
Scale 1:1

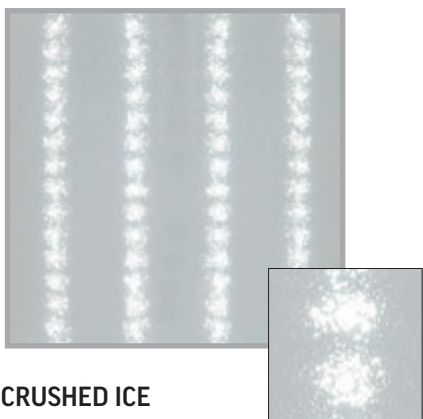

**CRUSHED ICE**

2.0mm thickness  
Light transmission 87%  
Material: polystyrene  
Scale 1:1

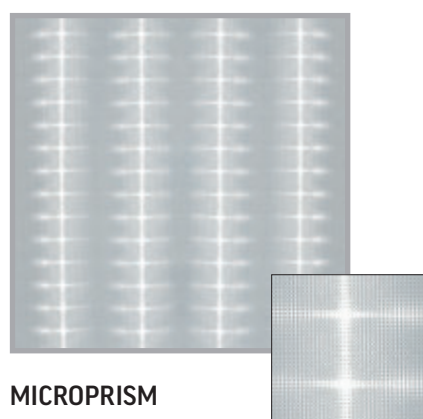

**MICROPRISM**

2.0mm thickness  
Light transmission 75%  
Material: Polycarbonate  
Scale 1:1



**FOR LAMPS IP65 STRONG**

Light transmission 78% (matt)  
Light transmission 93% (transparent)  
Material: Polycarbonate



# Tables of operation factor

Iron IP67 36W 4000K long										
Ceiling	80	80	80	70	70	70	50	50		
Walls	70	50	30	70	50	30	70	50		
Floor	20	20	20	20	20	20	20	20		
0.6	68	59	53	68	59	53	67	58		
0.8	78	68	62	77	68	62	75	67		
1	85	76	70	84	75	70	82	76		
1.25	91	82	77	90	82	76	87	80		
1.50	95	87	81	93	86	81	91	85		
2	100	93	88	99	92	87	95	90		
2.50	103	97	92	101	96	91	98	93		
3	106	100	96	104	99	95	100	96		
4	109	104	101	107	103	99	103	99		
5	111	107	104	109	105	102	104	101		

Iron IP67 36W 6500K long										
Ceiling	80	80	80	70	70	70	50	50		
Walls	70	50	30	70	50	30	70	50		
Floor	20	20	20	20	20	20	20	20		
0.6	69	60	54	69	59	54	68	59		
0.8	78	69	63	78	69	63	76	68		
1	85	77	71	84	76	71	82	77		
1.25	91	83	77	90	82	76	88	81		
1.50	95	88	82	94	87	82	91	85		
2	101	94	89	99	93	88	96	91		
2.50	103	97	92	102	96	92	98	93		
3	106	101	96	104	99	95	100	96		
4	109	105	101	107	103	99	103	100		
5	111	107	104	109	105	102	104	102		

Iron IP67 54W 3000K long										
Ceiling	80	80	80	70	70	70	50	50		
Walls	70	50	30	70	50	30	70	50		
Floor	20	20	20	20	20	20	20	20		
0.6	69	59	53	68	59	53	67	58		
0.8	78	68	62	77	68	62	75	67		
1	85	76	70	84	76	70	82	76		
1.25	91	83	77	90	82	77	87	81		
1.50	95	87	82	94	86	81	91	85		
2	100	94	88	99	92	88	96	90		
2.50	103	97	92	101	96	91	98	93		
3	106	100	96	104	99	95	100	96		
4	109	105	101	107	103	99	103	99		
5	111	107	104	109	105	102	104	102		

Iron Agro IP67 36W 3000K long										
Ceiling	80	80	80	70	70	70	50	50		
Walls	70	50	30	70	50	30	70	50		
Floor	20	20	20	20	20	20	20	20		
0.6	59	47	40	58	47	40	57	47		
0.8	69	58	51	68	57	50	66	57		
1	78	67	60	77	66	60	74	68		
1.25	85	75	68	84	74	68	81	73		
1.50	90	81	74	88	80	73	85	78		
2	97	89	83	95	88	82	92	85		
2.50	100	93	88	98	92	87	95	89		
3	104	97	92	102	96	91	98	93		
4	107	102	98	105	101	97	101	97		
5	110	105	102	107	103	100	103	100		

Iron Agro IP67 54W 6500K long										
Ceiling	80	80	80	70	70	70	50	50		
Walls	70	50	30	70	50	30	70	50		
Floor	20	20	20	20	20	20	20	20		
0.6	58	47	40	58	47	40	56	46		
0.8	69	57	50	68	57	50	66	56		
1	77	67	59	76	66	59	74	67		
1.25	85	74	68	83	74	67	81	72		
1.50	90	80	73	88	79	73	85	77		
2	96	88	82	95	87	81	91	85		
2.50	100	93	87	98	92	86	94	89		
3	103	97	92	101	96	91	97	93		
4	107	102	98	105	100	96	101	97		
5	110	105	101	107	103	100	103	100		

Iron Agro IP67 18W 4000K short										
Ceiling	80	80	80	70	70	70	50	50		
Walls	70	50	30	70	50	30	70	50		
Floor	20	20	20	20	20	20	20	20		
0.6	59	47	41	58	47	40	57	47		
0.8	69	58	51	68	57	50	66	57		
1	78	67	60	77	67	60	74	68		
1.25	85	75	68	84	74	68	81	73		
1.50	90	81	74	88	80	74	85	78		
2	97	89	83	95	88	82	92	85		
2.50	100	93	88	98	92	87	95	89		
3	104	97	92	102	96	91	98	93		
4	108	102	98	105	101	97	101	97		
5	110	105	102	107	103	100	103	100		

Iron IP67 54W 4000K long										
Ceiling	80	80	80	70	70	70	50	50		
Walls	70	50	30	70	50	30	70	50		
Floor	20	20	20	20	20	20	20	20		
0.6	68	58	52	67	58	52	66	58		
0.8	77	68	62	76	67	62	75	67		
1	84	75	69	83	75	69	81	76		
1.25	91	82	76	89	81	76	87	80		
1.50	95	87	81	93	86	81	90	84		
2	100	93	88	98	92	87	95	90		
2.50	103	97	92	101	95	91	98	93		
3	106	100	96	104	99	95	100	96		
4	109	104	100	107	103	99	103	99		
5	111	107	104	108	105	102	104	101		

Iron IP67 54W 6500K long										
Ceiling	80	80	80	70	70	70	50	50		
Walls	70	50	30	70	50	30	70	50		
Floor	20	20	20	20	20	20	20	20		
0.6	68	59	53	68	58	53	67	58		
0.8	78	68	62	77	68	62	75	67		
1	85	76	70	84	75	70	82	76		
1.25	91	82	77	90	82	76	87	80		
1.50	95	87	82	93	86	81	91	85		
2	100	93	88	99	92	87	95	90		
2.50	103	97	92	101	96	91	98	93		
3	106	100	96	104	99	95	100	96		
4	109	104	101	107	103	99	103	99		
5	111	107	104	109	105	102	104	101		

Iron IP67 18W 3000K short										
Ceiling	80	80	80	70	70	70	50	50		
Walls	70	50	30	70	50	30	70	50		
Floor	20	20	20	20	20	20	20	20		
0.6	69	59	53	68	59	53	67	58		
0.8	78	68	63	77	68	63	76	68		
1	85	76	70	84	76	70	82	77		
1.25	91	83	77	90	82	77	87	81		
1.50	95	87	82	94	87	81	91	85		
2	100	94	89	99	93	88	96	90		
2.50	103	97	92	102	96	92	98	93		
3	106	101	96	104	99	95	100	96		
4	109	105	101	107	103	99	103	100		
5	111	107	104	109	105	102	104	102		

Iron Agro IP67 27W 6500K short										
Ceiling	80	80	80	70	70	70	50	50		
Walls	70	50	30	70	50	30	70	50		
Floor	20	20	20	20	20	20	20	20		
0.6	59	47	40	58	47	40	57	46		
0.8	69	58	50	68	57	50	66	56		
1	78	67	60	76	66	60	74	68		
1.25	85	75	68	83	74	68	81	73		
1.50	90	80	74	88	80	73	85	78		
2	97	89	83	95	87	82	91	85		
2.50	100	93	87	98	92	87	95	89		
3	104	97	92	102	96	91	98	93		
4	107	102	98	105	100	97	101	97		
5	110	105	102	107	103	100	103	100		

Iron Lens 18W 6500K										
Ceiling	80	80	80	70	70	70	50	50		
Walls	70	50	30	70	50	30	70	50		
Floor	20	20	20	20	20	20	20	20		
0.6	81	74	69	81	74	69	80	73		
0.8	89	82	78	88	82	78	87	81		
1	94	88	83	94	87	83	92	87		
1.25	99	93	89	98	92	88	96	91		
1.50	102	97	92	101	96	92	99	94		
2	106	101	97	104	100	96	101	98		
2.50	108	103	100	106	102	99	103	100		
3	110	106	103	108	104	101	105	102		
4	112	109	106	110	107	105	106	104		
5	114	111	109	112	109	107	108	106		

Iron Lens 36W 6500K										
Ceiling	80	80	80	70	70	70	50	50		
Walls	70	50	30	70	50	30	70	50		
Floor	20	20	20	20	20					

# Tables of operation factor

A070 / A070 IP40 27W 3000K									
Ceiling	80	80	80	70	70	50	50		
Walls	70	50	30	70	50	30	70	50	
Floor	20	20	20	20	20	20	20	20	
0,6	58	47	40	57	46	39	56	46	
0,8	68	57	49	67	56	49	65	56	
1	77	66	59	76	65	58	73	67	
1,25	84	74	67	83	73	66	80	72	
1,50	89	79	73	87	79	72	84	77	
2	96	88	81	94	86	81	91	84	
2,50	100	92	86	98	91	86	94	88	
3	103	97	91	101	95	90	97	92	
4	107	102	97	105	100	96	100	96	
5	109	105	101	107	103	99	102	99	

A070 / A070 IP40 27W 4000K									
Ceiling	80	80	80	70	70	50	50		
Walls	70	50	30	70	50	30	70	50	
Floor	20	20	20	20	20	20	20	20	
0,6	58	46	39	57	46	39	56	46	
0,8	68	57	49	67	56	49	65	55	
1	77	66	59	76	65	58	73	67	
1,25	84	74	67	82	73	66	80	71	
1,50	89	79	72	87	78	72	84	77	
2	96	88	81	94	86	81	91	84	
2,50	100	92	86	98	91	85	94	88	
3	103	96	91	101	95	90	97	92	
4	107	102	97	105	100	96	100	96	
5	109	105	101	107	103	99	102	99	

A070 / A070 IP40 27W 6500K									
Ceiling	80	80	80	70	70	50	50		
Walls	70	50	30	70	50	30	70	50	
Floor	20	20	20	20	20	20	20	20	
0,6	58	46	39	57	46	39	56	45	
0,8	68	56	49	67	56	49	65	55	
1	76	65	58	75	65	58	73	66	
1,25	84	73	66	82	73	66	80	71	
1,50	89	79	72	87	78	72	84	76	
2	96	87	81	94	86	80	90	84	
2,50	100	92	86	98	91	85	94	88	
3	103	96	91	101	95	90	97	92	
4	107	101	97	105	100	96	100	96	
5	109	105	101	107	103	99	102	99	

A070 / A070 IP40 54W 3000K									
Ceiling	80	80	80	70	70	50	50		
Walls	70	50	30	70	50	30	70	50	
Floor	20	20	20	20	20	20	20	20	
0,6	58	47	40	58	47	40	56	46	
0,8	69	57	50	68	57	50	66	56	
1	77	66	59	76	66	59	74	67	
1,25	84	74	67	83	74	67	80	72	
1,50	89	80	73	88	79	73	85	77	
2	96	88	82	94	87	81	91	85	
2,50	100	93	87	98	91	86	94	89	
3	103	97	91	101	95	90	97	92	
4	107	102	97	105	100	96	101	97	
5	109	105	101	107	103	99	102	99	

A070 / A070 IP40 54W 4000K									
Ceiling	80	80	80	70	70	50	50		
Walls	70	50	30	70	50	30	70	50	
Floor	20	20	20	20	20	20	20	20	
0,6	58	47	40	58	47	40	56	45	
0,8	69	57	50	68	57	50	66	56	
1	77	66	59	76	66	59	74	67	
1,25	84	74	67	83	74	67	80	72	
1,50	89	80	73	88	79	73	85	77	
2	96	88	82	94	87	81	91	85	
2,50	100	93	87	98	91	86	94	89	
3	103	97	91	101	95	90	97	92	
4	107	102	97	105	100	96	101	97	
5	109	105	101	107	103	99	102	99	

A070 / A070 IP40 54W 6500K									
Ceiling	80	80	80	70	70	50	50		
Walls	70	50	30	70	50	30	70	50	
Floor	20	20	20	20	20	20	20	20	
0,6	58	46	39	57	46	39	56	46	
0,8	68	57	50	67	56	49	65	56	
1	77	66	59	76	65	59	74	67	
1,25	84	74	67	83	73	67	80	72	
1,50	89	80	73	88	79	72	85	77	
2	96	88	82	94	87	81	91	84	
2,50	100	92	86	98	91	86	94	88	
3	103	97	91	101	95	90	97	92	
4	107	102	97	105	100	96	100	96	
5	109	105	101	107	103	99	102	99	

A070 / A070 IP40 36W 2700K									
	80	80	80	70	70	50	50		
	70	50	30	70	50	30	70	50	
	20	20	20	20	20	20	20	20	
0,6	58	47	40	57	46	40	56	46	
0,8	68	57	50	67	56	49	66	56	
1	77	66	59	76	65	59	74	67	
1,25	84	74	67	83	73	67	80	72	
1,50	89	80	73	87	79	72	84	77	
2	96	88	82	94	87	81	91	84	
2,50	100	92	86	98	91	86	94	88	
3	103	97	91	101	95	90	97	92	
4	107	102	97	105	100	96	100	96	
5	109	105	101	107	103	99	102	99	

A070 / A070 IP40 36W 4000K									
	80	80	80	70	70	50	50		
	70	50	30	70	50	30	70	50	
	20	20	20	20	20	20	20	20	
0,6	58	46	39	57	46	39	56	46	
0,8	68	57	49	67	56	49	65	55	
1	77	66	59	76	65	58	73	67	
1,25	84	74	67	83	73	66	80	72	
1,50	89	79	73	87	78	72	84	77	
2	96	88	81	94	86	81	91	84	
2,50	100	92	86	98	91	86	94	88	
3	103	96	91	101	95	90	97	92	
4	107	102	97	105	100	96	100	96	
5	109	105	101	107	103	99	102	99	

A070 / A070 IP40 36W 6500K									
	80	80	80	70	70	50	50		
	70	50	30	70	50	30	70	50	
	20	20	20	20	20	20	20	20	
0,6	58	46	39	57	46	39	56	45	
0,8	68	56	49	67	56	49	65	55	
1	77	66	58	75	65	58	73	66	
1,25	84	73	66	82	73	66	80	71	
1,50	89	79	72	87	78	72	84	76	
2	96	87	81	94	86	80	90	84	
2,50	100	92	86	98	91	85	94	88	
3	103	96	91	101	95	90	97	92	
4	107	101	97	105	100	96	100	96	
5	109	105	101	107	103	99	102	99	

AKЦИЯ 25W 6500K									
Ceiling	80	80	80	70	70	50	50		
Walls	70	50	30	70	50	30	70	50	
Floor	20	20	20	20	20	20	20	20	
0,6	66	56	49	65	55	49	64	55	
0,8	76	66	59	75	65	59	73	64	
1	83	74	68	82	73	68	80	74	
1,25	90	81	75	88	80	75	86	79	
1,50	94	86	80	93	85	80	90	83	
2	100	93	87	98	92	87	95	89	
2,50	103	96	91	101	95	90	97	92	
3	105	100	95	103	98	94	100	95	
4	109	104	100	106	102	99	102	99	
5	111	107	103	108	105	102	104	101	

A270 / A270 IP40 36W 3000K									
Ceiling	80	80	80	70	70	50	50		
Walls	70	50	30	70	50	30	70	50	
Floor	20	20	20	20	20	20	20	20	
0,6	61	50	44	61	50	44	59	50	
0,8	71	61	54	70	60	54	69	59	
1	80	70	63	79	69	63	77	70	
1,25	87	77	71	85	77	70	83	75	
1,50	92	83	76	90	82	76	87	80	
2	98	90	85	96	89	84	93	87	
2,50	101	94	89	99	93	88	96	90	
3	104	98	93	102	97	92	98	94	
4	108	103	99	106	101	97	102	98	
5	110	106	102	108	104	101	103	100	

A270 / A270 IP40 36W 4000K									
Ceiling	80	80	80	70	70	50	50		
Walls	70	50	30	70	50	30	70	50	
Floor	20	20	20	20	20	20	20	20	
0,6	61	50	44	60	50	43	59	49	
0,8	71	61	54	70	60	54	69	59	
1	80	70	63	79	69	63	77	70	
1,25	87	77	71	85	76	70	83	75	
1,50	91	83	76	90	82	76	87	80	
2	98	90	84	96	89	84	93	87	
2,50	101	94	89	99	93	88	96	90	
3	104	98	93	102	97	92	98	94	
4	108	10							

# Tables of operation factor

A220 / A220 IP40 18W 3000K										
Ceiling	80	80	80	70	70	70	50	50		
Walls	70	50	30	70	50	30	70	50		
Floor	20	20	20	20	20	20	20	20	20	20
0.6	66	56	49	65	55	49	64	55		
0.8	76	66	59	75	65	59	73	64		
1	83	74	68	82	73	68	80	74		
1.25	90	81	75	88	80	75	86	79		
1.50	94	86	80	93	85	80	90	83		
2	100	93	87	98	92	87	95	89		
2.50	103	97	92	101	95	91	97	93		
3	106	100	95	104	99	94	100	96		
4	109	104	100	107	102	99	103	99		
5	111	107	104	108	105	102	104	101		

A220 / A220 IP40 18W 4000K										
Ceiling	80	80	80	70	70	70	50	50		
Walls	70	50	30	70	50	30	70	50		
Floor	20	20	20	20	20	20	20	20	20	20
0.6	65	55	49	64	55	49	63	54		
0.8	75	65	58	74	64	58	72	64		
1	83	73	67	82	73	67	80	74		
1.25	89	80	74	88	80	74	85	78		
1.50	94	85	80	92	85	79	89	83		
2	99	92	87	98	91	86	94	89		
2.50	103	96	91	101	95	90	97	92		
3	105	100	95	103	98	94	100	95		
4	109	104	95	103	98	94	100	95		
5	111	107	103	108	105	102	104	101		

A220 / A220 IP40 18W 6500K										
Ceiling	80	80	80	70	70	70	50	50		
Walls	70	50	30	70	50	30	70	50		
Floor	20	20	20	20	20	20	20	20	20	20
0.6	65	55	49	65	55	49	64	54		
0.8	75	65	59	74	65	59	73	64		
1	83	74	67	82	73	67	80	74		
1.25	89	81	75	88	80	74	86	79		
1.50	94	86	80	92	85	79	90	83		
2	100	93	87	98	91	86	95	89		
2.50	103	96	91	101	95	90	97	92		
3	105	100	95	103	98	94	100	95		
4	109	104	100	107	102	99	102	99		
5	111	107	103	108	105	102	104	101		

A350 / A350 IP40 36W 6500K										
Ceiling	80	80	80	70	70	70	50	50		
Walls	70	50	30	70	50	30	70	50		
Floor	20	20	20	20	20	20	20	20	20	20
0.6	58	46	39	57	46	39	56	46		
0.8	68	57	50	67	56	49	66	56		
1	77	66	59	76	66	59	74	67		
1.25	85	74	68	83	74	67	80	72		
1.50	90	80	73	88	79	73	85	77		
2	96	88	82	95	87	81	91	85		
2.50	100	93	87	98	91	86	94	89		
3	103	97	92	101	95	91	97	93		
4	107	102	97	105	100	96	101	97		
5	109	105	101	107	103	100	103	99		

A350 / A350 IP40 54W 4000K										
Ceiling	80	80	80	70	70	70	50	50		
Walls	70	50	30	70	50	30	70	50		
Floor	20	20	20	20	20	20	20	20	20	20
0.6	58	47	40	57	46	40	56	46		
0.8	68	57	50	67	57	50	66	56		
1	77	66	59	76	66	59	74	67		
1.25	84	74	67	83	74	67	80	72		
1.50	89	80	73	88	79	73	85	77		
2	96	88	82	95	87	81	91	85		
2.50	100	93	87	98	91	86	94	89		
3	103	97	92	101	95	91	97	93		
4	107	102	98	105	100	96	101	97		
5	109	105	101	107	103	100	103	99		

A350 / A350 IP40 54W 6500K										
Ceiling	80	80	80	70	70	70	50	50		
Walls	70	50	30	70	50	30	70	50		
Floor	20	20	20	20	20	20	20	20	20	20
0.6	58	46	39	57	46	39	56	45		
0.8	68	56	49	67	56	49	65	55		
1	77	66	59	76	65	58	73	67		
1.25	84	74	67	83	73	67	80	72		
1.50	89	80	73	88	79	72	85	77		
2	96	88	82	94	87	81	91	84		
2.50	100	92	87	98	91	86	94	88		
3	103	97	91	101	95	90	97	92		
4	107	102	97	105	100	96	101	97		
5	109	105	101	107	103	99	103	99		

A220 / A220 IP40 36W 4000K										
Ceiling	80	80	80	70	70	70	50	50		
Walls	70	50	30	70	50	30	70	50		
Floor	20	20	20	20	20	20	20	20	20	20
0.6	65	55	48	64	54	48	63	54		
0.8	75	65	58	74	64	58	72	64		
1	83	73	67	82	73	67	79	74		
1.25	89	80	74	88	80	74	85	78		
1.50	94	85	79	92	84	79	89	83		
2	99	92	87	98	91	86	94	89		
2.50	103	96	91	101	95	90	97	92		
3	105	100	95	103	98	94	99	95		
4	109	104	100	106	102	99	102	99		
5	111	107	103	108	105	102	104	101		

A220 / A220 IP40 36W 6500K										
Ceiling	80	80	80	70	70	70	50	50		
Walls	70	50	30	70	50	30	70	50		
Floor	20	20	20	20	20	20	20	20	20	20
0.6	65	54	48	64	54	48	63	54		
0.8	74	64	58	74	64	58	72	63		
1	82	73	66	81	72	66	79	73		
1.25	89	80	74	88	79	73	85	78		
1.50	93	85	79	92	84	79	89	82		
2	99	92	87	97	91	86	94	89		
2.50	102	96	91	100	95	90	97	92		
3	105	99	95	103	98	94	99	95		
4	109	104	100	106	102	99	102	99		
5	111	107	103	108	105	102	104	101		

A370 / A370 IP40 18W 3000K										
Ceiling	80	80	80	70	70	70	50	50		
Walls	70	50	30	70	50	30	70	50		
Floor	20	20	20	20	20	20	20	20	20	20
0.6	59	48	41	58	47	41	57	47		
0.8	69	58	51	68	58	51	67	57		
1	78	68	61	77	67	60	75	68		
1.25	85	76	69	84	75	68	81	73		
1.50	90	81	75	89	80	74	86	79		
2	97	89	83	95	88	82	92	86		
2.50	101	94	88	99	92	87	95	90		
3	104	98	93	102	96	91	98	93		
4	108	102	98	105	101	97	101	97		
5	110	105	102	107	103	100	103	100		

G070 27W 3000K										
Ceiling	80	80	80	70	70	70	50	50		
Walls	70	50	30	70	50	30	70	50		
Floor	20	20	20	20	20	20	20	20	20	20
0.6	58	47	40	58	47	40	56	46		
0.8	69	57	50	68	57	50	66	56		
1	77	66	59	76	66	59	74	67		
1.25	84	74	67	83	74	67	80	72		
1.50	89	80	73	88	79	73	85	77		
2	96	88	82	94	87	81	91	85		
2.50	100	93	87	98	91	86	94	89		
3	103	97	92	101	95	91	97	92		
4	107	102	97	105	100	96	101	97		
5	109	105	101	107	103	100	103	99		

G070 27W 4000K										
Ceiling	80	80	80	70	70	70	50	50		
Walls	70	50	30	70	50	30	70	50		
Floor	20	20	20	20	20	20	20	20	20	20
0.6	58	47	40	58	47	40	56	46		
0.8	69	57	50	68	57	50	66	56		
1	77	66	59	76	66	59	74	67		
1.25	84	74	67	83	74	67	80	72		
1.50	89	80	73	88	79	73	85	77		
2	96	88	82	94	87	81	91	85		
2.50	100	93	87	98	91	86	94	89		
3	103	97	92	101	95	91	97	92		
4	107	102	97	105	100	96	101	97		
5	109	105	101	107	103	100	103	99		

G070 27W 6500K										
Ceiling	80	80	80	70	70	70	50	50		
Walls	70	50	30	70</						

# Tables of operation factor

A070/OT 36W 6500K										
Ceiling	80	80	80	70	70	70	50	50		
Walls	70	50	30	70	50	30	70	50		
Floor	20	20	20	20	20	20	20	20	20	20
0.6	62	52	45	62	51	45	61	51		
0.8	73	62	55	72	62	55	70	61		
1	81	71	64	80	70	64	78	72		
1.25	88	78	72	86	78	72	84	76		
1.50	92	84	78	91	83	77	88	81		
2	98	91	85	97	90	85	93	88		
2.50	102	95	90	100	94	89	96	91		
3	105	99	94	103	97	93	99	94		
4	108	103	99	106	101	98	102	98		
5	110	106	102	108	104	101	103	100		

A300 / A300 IP40 72W 3000K										
Ceiling	80	80	80	70	70	70	50	50		
Walls	70	50	30	70	50	30	70	50		
Floor	20	20	20	20	20	20	20	20	20	20
0.6	58	46	39	57	46	39	56	45		
0.8	68	56	49	67	56	49	65	55		
1	77	66	58	75	65	58	73	66		
1.25	84	73	66	82	73	66	80	71		
1.50	89	79	72	87	78	72	84	76		
2	96	87	81	94	86	80	90	84		
2.50	100	92	86	98	91	85	94	88		
3	103	96	91	101	95	90	97	92		
4	107	101	97	105	100	96	100	96		
5	109	105	101	107	103	99	102	99		

A300 / A300 IP40 72W 4000K										
Ceiling	80	80	80	70	70	70	50	50		
Walls	70	50	30	70	50	30	70	50		
Floor	20	20	20	20	20	20	20	20	20	20
0.6	58	46	39	57	46	39	56	45		
0.8	68	56	49	67	56	49	65	55		
1	76	65	58	75	65	58	73	66		
1.25	84	73	66	82	73	66	80	71		
1.50	89	79	72	87	78	72	84	76		
2	96	87	81	94	86	80	90	84		
2.50	100	92	86	98	91	85	94	88		
3	103	96	91	101	95	90	97	92		
4	107	101	97	105	100	95	100	96		
5	109	105	101	107	103	99	102	99		

ARMSTRONG. CLIP-IN IP54 4000K										
Ceiling	80	80	80	70	70	70	50	50		
Walls	70	50	30	70	50	30	70	50		
Floor	20	20	20	20	20	20	20	20	20	20
0.6	58	46	39	57	46	39	56	45		
0.8	68	57	49	67	56	49	65	55		
1	77	66	59	76	65	58	73	67		
1.25	84	74	67	83	73	66	80	72		
1.50	89	79	73	87	78	72	84	77		
2	96	88	81	94	86	81	91	84		
2.50	100	92	86	98	91	86	94	88		
3	103	96	91	101	95	90	97	92		
4	107	102	97	105	100	96	100	96		
5	109	105	101	107	103	99	102	99		

EARMSTRONG. CLIP-IN IP40 6500K										
Ceiling	80	80	80	70	70	70	50	50		
Walls	70	50	30	70	50	30	70	50		
Floor	20	20	20	20	20	20	20	20	20	20
0.6	58	46	39	57	46	39	56	45		
0.8	68	56	49	67	56	49	65	55		
1	77	66	58	75	65	58	73	66		
1.25	84	73	66	82	73	66	80	71		
1.50	89	79	72	87	78	72	84	76		
2	96	87	81	94	86	80	90	84		
2.50	100	92	86	98	91	85	94	88		
3	103	96	91	101	95	90	97	92		
4	107	101	97	105	100	96	100	96		
5	109	105	101	107	103	99	102	99		

ARMSTRONG. CLIP-IN IP54 6500K										
Ceiling	80	80	80	70	70	70	50	50		
Walls	70	50	30	70	50	30	70	50		
Floor	20	20	20	20	20	20	20	20	20	20
0.6	58	46	39	57	46	39	56	45		
0.8	68	56	49	67	56	49	65	55		
1	77	66	58	75	65	58	73	66		
1.25	84	73	66	82	73	66	80	71		
1.50	89	79	72	87	78	72	84	76		
2	96	87	81	94	86	80	90	84		
2.50	100	92	86	98	91	85	94	88		
3	103	96	91	101	95	90	97	92		
4	107	101	97	105	100	96	100	96		
5	109	105	101	107	103	99	102	99		

A300 / A300 IP40 72W 6500K										
Ceiling	80	80	80	70	70	70	50	50		
Walls	70	50	30	70	50	30	70	50		
Floor	20	20	20	20	20	20	20	20	20	20
0.6	57	46	39	57	46	39	55	45		
0.8	68	56	49	67	56	49	65	55		
1	76	65	58	75	65	58	73	66		
1.25	84	73	66	82	72	66	79	71		
1.50	89	79	72	87	78	71	84	76		
2	96	87	81	94	86	80	90	84		
2.50	99	92	86	97	90	85	94	88		
3	103	96	91	101	95	90	97	92		
4	107	101	97	104	100	95	100	96		
5	109	104	101	107	103	99	102	99		

ECOPHON 36W 4000K										
Ceiling	80	80	80	70	70	70	50	50		
Walls	70	50	30	70	50	30	70	50		
Floor	20	20	20	20	20	20	20	20	20	20
0.6	58	46	39	57	46	39	56	46		
0.8	68	57	49	67	56	49	65	55		
1	77	66	59	76	65	58	73	67		
1.25	84	74	67	83	73	66	80	72		
1.50	89	79	73	87	78	72	84	77		
2	96	88	81	94	86	81	91	84		
2.50	100	92	86	98	91	86	94	88		
3	103	96	91	101	95	90	97	92		
4	107	102	97	105	100	96	100	96		
5	109	105	101	107	103	99	102	99		

ECOPHON 36W 6500K										
Ceiling	80	80	80	70	70	70	50	50		
Walls	70	50	30	70	50	30	70	50		
Floor	20	20	20	20	20	20	20	20	20	20
0.6	58	46	39	57	46	39	56	45		
0.8	68	56	49	67	56	49	65	55		
1	77	66	58	75	65	58	73	66		
1.25	84	73	66	82	73	66	80	71		
1.50	89	79	72	87	78	72	84	76		
2	96	87	81	94	86	80	90	84		
2.50	100	92	86	98	91	85	94	88		
3	103	96	91	101	95	90	97	92		
4	107	101	97	105	100	96	100	96		
5	109	105	101	107	103	99	102	99		

ARMSTRONG. CLIP-IN IP54 6500K										
Ceiling	80	80	80	70	70	70	50	50		
Walls	70	50	30	70	50	30	70	50		
Floor	20	20	20	20	20	20	20	20	20	20
0.6	58	46	39	57	46	39	56	45		
0.8	68	56	49	67	56	49	65	55		
1	77	66	58	75	65	58	73	66		
1.25	84	73	66	82	73	66	80	71		
1.50	89	79	72	87	78	72	84	76		
2	96	87	81	94	86	80	90	84		
2.50	100	92	86	98	91	85	94	88		
3	103	96	91	101	95	90	97	92		
4	107	101	97	105	100	96	100	96		
5	109	105	101	107	103	99	102	99		

TEGULAR 36W 4000K										
Ceiling	80	80	80	70	70	70	50	50		
Walls	70	50	30	70	50	30	70	50		
Floor	20	20	20	20	20	20	20	20	20	20
0.6	58	46	39	57	46	39	56	46		
0.8	68	57	49	67	56	49	65	55		
1	77	66	59	76	65	58	73	67		
1.25	84	74	67	83	73	66	80	72		
1.50	89	79	73	87	78	72	84	77		
2	96	88	81	94	86	81	91	84		
2.50	100	92	86	98	91	86	94	88		
3	103	96	91	101	95	90	97	92		
4	107	102	97	105	100	96	100	96		
5	109	105	101	107	103	99	102	99		

TEGULAR 36W 6500K										
Ceiling	80	80	80	70	70	70	50	50		
Walls	70	50	30	70	50	30	70	50		
Floor	20	20	20							

# Tables of operation factor

C270 / C270N 36W 3000K										
Ceiling	80	80	80	70	70	50	50			
Walls	70	50	30	70	50	30	70	50		
Floor	20	20	20	20	20	20	20	20	20	20
0.6	61	50	43	60	49	43	59	49		
0.8	71	60	53	70	59	53	68	59		
1	79	69	62	78	68	61	76	69		
1.25	86	76	69	84	75	69	82	74		
1.50	91	81	75	89	81	74	86	79		
2	97	89	83	95	88	82	92	86		
2.50	101	93	88	99	92	87	95	90		
3	104	97	92	102	96	91	98	93		
4	107	102	98	105	101	97	101	97		
5	110	105	102	107	103	100	103	100		

C270 / C270N 36W 4000K										
Ceiling	80	80	80	70	70	50	50			
Walls	70	50	30	70	50	30	70	50		
Floor	20	20	20	20	20	20	20	20	20	20
0.6	61	49	43	60	49	43	59	49		
0.8	71	60	53	70	59	52	68	58		
1	79	68	61	78	68	61	75	69		
1.25	86	76	69	84	75	69	82	74		
1.50	90	81	75	89	80	74	86	79		
2	97	89	83	95	88	82	92	86		
2.50	101	93	88	99	92	87	95	89		
3	104	97	92	102	96	91	98	93		
4	107	102	98	105	101	96	101	97		
5	110	105	102	107	103	100	103	100		

C270 / C270N 36W 6500K										
Ceiling	80	80	80	70	70	50	50			
Walls	70	50	30	70	50	30	70	50		
Floor	20	20	20	20	20	20	20	20	20	20
0.6	61	50	43	60	49	43	59	49		
0.8	71	60	53	70	59	53	68	58		
1	79	68	62	78	68	61	76	69		
1.25	86	76	69	84	75	69	82	74		
1.50	91	81	75	89	80	74	86	79		
2	97	89	83	95	88	82	92	86		
2.50	101	93	88	99	92	87	95	89		
3	104	97	92	102	96	91	98	93		
4	107	102	98	105	100	97	101	97		
5	110	105	102	107	103	100	103	100		

S270 36W 6500K										
Ceiling	80	80	80	70	70	50	50			
Walls	70	50	30	70	50	30	70	50		
Floor	20	20	20	20	20	20	20	20	20	20
0.6	61	50	43	60	50	43	59	49		
0.8	71	60	53	70	60	53	68	59		
1	80	69	63	78	69	62	76	70		
1.25	87	77	70	85	76	70	83	75		
1.50	91	82	76	90	81	75	87	80		
2	98	90	84	96	89	83	93	87		
2.50	101	94	89	99	93	88	96	90		
3	104	98	93	102	97	92	98	94		
4	108	103	99	106	101	97	101	98		
5	110	106	102	108	104	100	103	100		

S270 54W 4000K										
Ceiling	80	80	80	70	70	50	50			
Walls	70	50	30	70	50	30	70	50		
Floor	20	20	20	20	20	20	20	20	20	20
0.6	60	49	42	59	49	42	58	48		
0.8	71	60	53	70	59	52	68	58		
1	79	69	62	78	68	62	76	69		
1.25	86	77	70	85	76	70	82	74		
1.50	91	82	76	89	81	75	87	79		
2	98	90	84	96	87	83	92	87		
2.50	101	94	89	99	93	88	95	90		
3	104	98	93	102	97	92	98	94		
4	108	103	99	105	101	97	101	98		
5	110	106	102	108	104	100	103	100		

S270 54W 6500K										
Ceiling	80	80	80	70	70	50	50			
Walls	70	50	30	70	50	30	70	50		
Floor	20	20	20	20	20	20	20	20	20	20
0.6	60	49	42	59	49	42	58	48		
0.8	70	59	52	69	59	52	68	58		
1	79	69	62	78	68	62	76	69		
1.25	86	76	70	85	76	70	82	74		
1.50	91	82	75	89	81	75	86	79		
2	97	90	84	96	89	83	92	86		
2.50	101	94	89	99	93	88	95	90		
3	104	98	93	102	96	92	98	94		
4	108	103	98	105	101	97	101	98		
5	110	106	102	107	104	100	103	100		

E070 / E070 IP40 36W 4000K										
Ceiling	80	80	80	70	70	50	50			
Walls	70	50	30	70	50	30	70	50		
Floor	20	20	20	20	20	20	20	20	20	20
0.6	58	46	39	57	46	39	56	46		
0.8	68	57	49	67	56	49	65	55		
1	77	66	59	76	65	58	73	67		
1.25	84	74	67	82	73	66	80	71		
1.50	89	79	72	87	78	72	84	77		
2	96	88	81	94	86	81	91	84		
2.50	100	92	86	98	91	85	94	88		
3	103	96	91	101	95	90	97	92		
4	107	102	97	105	100	96	100	96		
5	109	105	101	107	103	99	102	99		

E220 18W 4000K										
Ceiling	80	80	80	70	70	50	50			
Walls	70	50	30	70	50	30	70	50		
Floor	20	20	20	20	20	20	20	20	20	20
0.6	57	45	38	56	45	38	55	44		
0.8	67	55	48	66	55	48	64	54		
1	76	65	57	75	64	57	72	65		
1.25	83	72	65	82	72	65	79	70		
1.50	88	78	71	86	77	71	83	76		
2	95	87	80	93	85	79	90	83		
2.50	99	91	85	97	90	85	93	87		
3	103	96	90	100	94	89	96	91		
4	107	101	96	104	99	95	100	96		
5	109	104	100	107	102	99	102	99		

E270 / E270 IP40 36W 4000K										
Ceiling	80	80	80	70	70	50	50			
Walls	70	50	30	70	50	30	70	50		
Floor	20	20	20	20	20	20	20	20	20	20
0.6	61	50	44	61	50	44	59	50		
0.8	71	60	54	70	60	53	69	59		
1	80	69	62	78	69	62	76	70		
1.25	86	77	70	85	76	70	82	75		
1.50	91	82	76	90	81	75	87	79		
2	97	90	84	96	89	83	92	86		
2.50	101	94	88	99	93	88	95	90		
3	104	98	93	102	96	92	98	93		
4	108	103	98	105	101	97	101	98		
5	110	106	102	108	104	100	103	100		

LUX 18W 3000K										
Ceiling	80	80	80	70	70	50	50			
Walls	70	50	30	70	50	30	70	50		
Floor	20	20	20	20	20	20	20	20	20	20
0.6	61	50	43	60	49	43	59	49		
0.8	71	60	53	70	60	53	68	59		
1	80	70	63	79	69	63	76	70		
1.25	87	77	71	85	77	70	83	75		
1.50	92	83	76	90	82	76	87	80		
2	98	90	85	96	89	84	93	87		
2.50	101	95	89	100	93	88	96	91		
3	105	99	94	102	97	93	99	94		
4	108	103	99	106	101	98	102	98		
5	110	106	102	108	104	100	103	100		

LUX 18W 4000K										
Ceiling	80	80	80	70	70	50	50			
Walls	70	50	30	70	50	30	70	50		
Floor	20	20	20	20	20	20	20	20	20	20
0.6	61	50	43	60	49	43	59	49		
0.8	71	60	53	70	60	53	68	59		
1	80	69	63	79	69	62	76	70		
1.25	87	77	71	85	76	70	83	75		
1.50	92	83	76	90	82	76	87	80		
2	98	90	85	96	89	84	93	87		
2.50	101	95	89	99	93	88	96	91		
3	104	98	94	102	97	93	99	94		
4	108	103	9							

# Tables of operation factor

ЖКХ 10W 4000K круглый									
Ceiling	80	80	80	70	70	70	50	50	50
Walls	70	50	30	70	50	30	70	50	50
Floor	20	20	20	20	20	20	20	20	20
0.6	55	43	36	55	43	36	53	43	43
0.8	65	53	45	64	52	45	62	52	52
1	73	61	54	72	61	53	70	62	62
1.25	80	69	61	79	68	61	76	67	67
1.50	85	75	67	84	74	66	80	72	72
2	92	83	76	90	82	75	87	79	79
2.50	96	88	81	94	86	80	90	84	84
3	100	92	86	98	91	85	93	88	88
4	104	98	92	102	96	91	97	92	92
5	107	101	96	104	99	95	100	95	95

Market-Line 36W 4000K									
Ceiling	80	80	80	70	70	70	50	50	50
Walls	70	50	30	70	50	30	70	50	50
Floor	20	20	20	20	20	20	20	20	20
0.6	65	55	49	64	54	48	63	54	54
0.8	75	65	58	74	64	58	72	64	64
1	83	73	67	82	73	67	80	74	74
1.25	89	80	74	88	80	74	85	78	78
1.50	94	85	79	92	84	79	89	83	83
2	99	92	87	98	91	86	94	89	89
2.50	102	96	91	101	95	90	97	92	92
3	105	99	95	103	98	94	99	95	95
4	109	104	100	106	102	98	102	99	99
5	110	106	103	108	104	101	104	101	101

Market-Line 36W 6500K									
Ceiling	80	80	80	70	70	70	50	50	50
Walls	70	50	30	70	50	30	70	50	50
Floor	20	20	20	20	20	20	20	20	20
0.6	65	55	48	64	54	48	63	54	54
0.8	75	65	58	74	64	58	72	63	63
1	83	73	67	82	73	67	79	74	74
1.25	89	80	74	88	80	74	85	78	78
1.50	94	85	79	92	84	79	89	83	83
2	99	92	87	98	91	86	94	89	89
2.50	102	96	91	101	95	90	97	92	92
3	105	99	95	103	98	94	99	95	95
4	108	104	100	106	102	98	102	99	99
5	110	106	103	108	104	101	104	101	101

GR070 36W 4000K									
Ceiling	80	80	80	70	70	70	50	50	50
Walls	70	50	30	70	50	30	70	50	50
Floor	20	20	20	20	20	20	20	20	20
0.6	58	46	39	57	46	39	56	46	46
0.8	68	57	49	67	56	49	65	55	55
1	77	66	59	76	65	58	73	67	67
1.25	84	74	67	82	73	66	80	71	71
1.50	89	79	72	87	78	72	84	77	77
2	96	88	81	94	86	81	91	84	84
2.50	100	92	86	98	91	85	94	88	88
3	103	96	91	101	95	90	97	92	92
4	107	102	97	105	100	96	100	96	96
5	109	105	101	107	103	99	102	99	99

GR070 36W 6500K									
Ceiling	80	80	80	70	70	70	50	50	50
Walls	70	50	30	70	50	30	70	50	50
Floor	20	20	20	20	20	20	20	20	20
0.6	58	46	39	57	46	39	56	45	45
0.8	68	56	49	67	56	49	65	55	55
1	76	65	58	75	65	58	73	66	66
1.25	84	73	66	82	73	66	80	71	71
1.50	89	79	72	87	78	72	84	76	76
2	96	87	81	94	86	80	90	84	84
2.50	100	92	86	98	91	85	94	88	88
3	103	96	91	101	95	90	97	92	92
4	107	101	97	104	100	96	100	96	96
5	109	105	101	107	103	99	102	99	99

GR070 54W 4000K									
Ceiling	80	80	80	70	70	70	50	50	50
Walls	70	50	30	70	50	30	70	50	50
Floor	20	20	20	20	20	20	20	20	20
0.6	58	47	40	58	47	40	57	46	46
0.8	69	57	50	68	57	50	66	56	56
1	77	67	60	76	66	59	74	67	67
1.25	85	74	68	83	74	67	81	72	72
1.50	90	80	73	88	79	73	85	77	77
2	96	88	82	94	87	81	91	85	85
2.50	100	93	87	98	91	86	94	89	89
3	103	97	92	101	95	90	97	92	92
4	107	102	97	105	100	96	101	97	97
5	109	105	101	107	103	99	102	99	99

Market-Line 54W 4000K									
Ceiling	80	80	80	70	70	70	50	50	50
Walls	70	50	30	70	50	30	70	50	50
Floor	20	20	20	20	20	20	20	20	20
0.6	65	55	48	64	54	48	63	54	54
0.8	75	64	58	74	64	58	72	63	63
1	82	73	67	81	72	66	79	73	73
1.25	89	80	74	88	79	74	85	78	78
1.50	93	85	79	92	84	79	89	82	82
2	99	92	87	97	91	86	94	89	89
2.50	102	96	91	100	94	90	97	92	92
3	105	99	95	103	98	94	99	95	95
4	108	104	100	106	102	98	102	99	99
5	110	106	103	108	104	101	104	101	101

Market-Line 54W 4000K									
Ceiling	80	80	80	70	70	70	50	50	50
Walls	70	50	30	70	50	30	70	50	50
Floor	20	20	20	20	20	20	20	20	20
0.6	65	54	48	64	54	48	63	53	53
0.8	75	64	58	73	64	58	72	63	63
1	82	73	66	81	72	66	79	73	73
1.25	89	80	74	88	79	73	85	78	78
1.50	93	85	79	92	84	79	89	82	82
2	99	92	86	97	91	86	94	89	89
2.50	102	96	91	100	94	90	97	92	92
3	105	99	95	103	98	94	99	95	95
4	108	104	100	106	102	98	102	99	99
5	110	106	103	108	104	101	104	101	101

T-Line 36W 3000K									
Ceiling	80	80	80	70	70	70	50	50	50
Walls	70	50	30	70	50	30	70	50	50
Floor	20	20	20	20	20	20	20	20	20
0.6	62	51	45	61	51	45	60	51	51
0.8	72	62	55	71	61	55	70	60	60
1	81	71	64	79	70	64	77	71	71
1.25	87	78	72	86	77	71	83	76	76
1.50	92	83	77	90	82	77	88	81	81
2	98	91	85	96	90	84	93	87	87
2.50	102	95	89	100	93	89	96	91	91
3	105	99	94	103	97	93	99	94	94
4	108	103	99	106	101	98	102	98	98
5	110	106	102	108	104	101	103	100	100

GR070 54W 6500K									
Ceiling	80	80	80	70	70	70	50	50	50
Walls	70	50	30	70	50	30	70	50	50
Floor	20	20	20	20	20	20	20	20	20
0.6	58	46	39	57	46	39	56	45	45
0.8	68	57	49	67	56	49	65	55	55
1	77	66	59	76	65	58	73	67	67
1.25	84	74	67	83	73	66	80	72	72
1.50	89	79	73	87	79	72	84	77	77
2	96	88	81	94	86	81	91	84	84
2.50	100	92	86	98	91	86	94	88	88
3	103	96	91	101	95	90	97	92	92
4	107	101	97	105	100	96	100	96	96
5	109	105	101	107	103	99	102	99	99

GR060/N 36W 3000K									
Ceiling	80	80	80	70	70	70	50	50	50
Walls	70	50	30	70	50	30	70	50	50
Floor	20	20	20	20	20	20	20	20	20
0.6	58	47	40	58	47	40	56	46	46
0.8	69	57	50	68	57	50	66	56	56
1	77	66	59	76	66	59	74	67	67
1.25	84	74	67	83	74	67	80	72	72
1.50	89	80	73	88	79	73	85	77	77
2	96	88	82	94	87	81	91	85	85
2.50	100	93	87	98	91	86	94	89	89
3	103	97	92	101	95	90	97	92	92
4	107	102	97	105	100	96	101	97	97
5	109	105	101	107	103	99	103	99	99

GR060/N 36W 4000K									
Ceiling	80	80	80	70	70	70	50	50	50
Walls	70	50	30	70	50	30	70	50	50
Floor	20	20	20	20	20	20	20	20	20
0.6	58	47	40	57	46	40	56	46	46
0.8	69	57	50	67	57	50	66	56	56
1	77	66	59	76	6				

# Tables of operation factor

DL CIRCLE 13W 3000K								
Ceiling	80	80	80	70	70	70	50	50
Walls	70	50	30	70	50	30	70	50
Floor	20	20	20	20	20	20	20	20
0.6	60	49	42	59	49	42	58	48
0.8	70	59	52	69	58	52	67	58
1	78	68	61	77	67	60	75	68
1.25	85	75	68	84	75	68	81	73
1.50	90	81	74	88	80	74	85	78
2	97	89	82	95	87	82	91	85
2.50	100	93	87	98	92	86	94	89
3	103	97	92	101	95	91	97	93
4	107	102	98	105	100	96	101	97
5	109	105	101	107	103	100	103	99

DL CIRCLE 20W 3000K								
Ceiling	80	80	80	70	70	70	50	50
Walls	70	50	30	70	50	30	70	50
Floor	20	20	20	20	20	20	20	20
0.6	60	49	42	59	49	42	58	48
0.8	70	59	52	69	58	52	67	58
1	78	68	61	77	67	60	75	68
1.25	85	75	68	84	75	68	81	73
1.50	90	81	74	88	80	74	85	78
2	97	88	82	95	87	82	91	85
2.50	100	93	87	98	92	86	94	89
3	103	97	92	101	95	91	97	93
4	107	102	97	105	100	96	101	97
5	109	105	101	107	103	100	103	99

DL CIRCLE 30W 3000K								
Ceiling	80	80	80	70	70	70	50	50
Walls	70	50	30	70	50	30	70	50
Floor	20	20	20	20	20	20	20	20
0.6	60	49	42	59	48	42	58	48
0.8	70	59	52	69	58	51	67	57
1	78	67	60	77	67	60	75	68
1.25	85	75	68	84	74	68	81	73
1.50	90	80	74	88	80	73	85	78
2	96	88	82	95	87	81	91	85
2.50	100	93	87	98	91	86	94	89
3	103	97	92	101	95	91	97	92
4	107	102	97	105	100	96	101	97
5	109	105	101	107	103	99	103	99

STRONG IP65 18W 4000K long								
Ceiling	80	80	80	70	70	70	50	50
Walls	70	50	30	70	50	30	70	50
Floor	20	20	20	20	20	20	20	20
0.6	57	45	38	56	45	38	55	45
0.8	67	55	48	66	55	48	64	54
1	76	64	57	74	64	57	72	65
1.25	83	72	65	81	72	65	79	70
1.50	88	78	71	86	77	70	83	75
2	95	86	80	93	85	79	90	83
2.50	99	91	85	97	90	84	93	87
3	102	95	90	100	94	89	96	91
4	106	101	96	104	99	95	100	95
5	109	104	100	106	102	98	102	98

STRONG IP65 18W 6500K long								
Ceiling	80	80	80	70	70	70	50	50
Walls	70	50	30	70	50	30	70	50
Floor	20	20	20	20	20	20	20	20
0.6	57	45	38	56	45	38	55	44
0.8	67	55	48	66	55	47	64	54
1	75	64	57	74	64	57	72	65
1.25	83	72	65	81	71	64	78	70
1.50	88	78	71	86	77	70	83	75
2	95	86	80	93	85	79	89	83
2.50	99	91	85	97	90	84	93	87
3	102	95	90	100	94	89	96	91
4	106	100	96	104	99	94	100	95
5	109	104	100	106	102	98	102	98

STRONG IP65 36W 4000K long								
Ceiling	80	80	80	70	70	70	50	50
Walls	70	50	30	70	50	30	70	50
Floor	20	20	20	20	20	20	20	20
0.6	57	45	38	56	45	38	55	44
0.8	67	55	48	66	55	48	64	54
1	76	64	57	74	64	57	72	65
1.25	83	72	65	81	72	65	79	70
1.50	88	78	71	86	77	70	83	75
2	95	86	80	93	85	79	90	83
2.50	99	91	85	97	90	84	93	87
3	102	95	90	100	94	89	96	91
4	106	101	96	104	99	95	100	95
5	109	104	100	106	102	98	102	98

DL CIRCLE 13W 4000K								
Ceiling	80	80	80	70	70	70	50	50
Walls	70	50	30	70	50	30	70	50
Floor	20	20	20	20	20	20	20	20
0.6	60	49	42	59	49	42	58	48
0.8	70	59	52	69	59	52	67	58
1	78	68	61	77	67	61	75	68
1.25	85	75	69	84	75	68	81	73
1.50	90	81	74	88	80	74	86	78
2	97	89	83	95	87	82	91	85
2.50	100	93	87	98	92	86	95	89
3	103	97	92	101	96	91	97	93
4	107	102	98	105	100	96	101	97
5	110	105	101	107	103	100	103	99

DL CIRCLE 20W 4000K								
Ceiling	80	80	80	70	70	70	50	50
Walls	70	50	30	70	50	30	70	50
Floor	20	20	20	20	20	20	20	20
0.6	60	49	42	59	48	42	58	48
0.8	70	59	51	69	58	51	67	57
1	78	67	60	77	67	60	75	68
1.25	85	75	68	84	74	68	81	73
1.50	90	80	74	88	80	73	85	78
2	96	88	82	95	87	81	91	85
2.50	100	93	87	98	91	86	94	89
3	103	97	92	101	95	90	97	92
4	107	102	97	105	100	96	101	97
5	109	105	101	107	103	99	103	99

DL CIRCLE 30W 4000K								
Ceiling	80	80	80	70	70	70	50	50
Walls	70	50	30	70	50	30	70	50
Floor	20	20	20	20	20	20	20	20
0.6	59	48	41	59	48	41	57	47
0.8	69	58	51	68	58	51	67	57
1	78	67	60	77	66	60	74	68
1.25	85	75	68	83	74	67	81	72
1.50	90	80	73	88	79	73	85	77
2	96	88	82	94	87	81	91	85
2.50	100	92	87	98	91	86	94	88
3	103	97	91	101	95	90	97	92
4	107	102	97	105	100	96	100	96
5	109	105	101	107	103	99	102	99

STRONG IP65 36W 6500K long								
Ceiling	80	80	80	70	70	70	50	50
Walls	70	50	30	70	50	30	70	50
Floor	20	20	20	20	20	20	20	20
0.6	57	45	38	56	45	38	55	44
0.8	67	55	47	66	54	47	64	54
1	75	64	57	74	63	56	72	65
1.25	83	72	65	81	71	64	78	70
1.50	88	78	70	86	77	70	83	75
2	95	86	79	93	85	79	89	82
2.50	99	91	85	97	89	84	93	87
3	102	95	90	100	94	89	96	91
4	106	100	96	104	99	94	99	95
5	109	104	100	106	102	98	102	98

STRONG IP65 54W 4000K long								
Ceiling	80	80	80	70	70	70	50	50
Walls	70	50	30	70	50	30	70	50
Floor	20	20	20	20	20	20	20	20
0.6	57	45	38	56	45	38	55	44
0.8	67	55	48	66	55	48	64	54
1	76	64	57	74	63	56	72	65
1.25	83	72	65	81	71	65	79	70
1.50	88	78	71	86	77	70	83	75
2	95	86	80	93	85	79	89	83
2.50	99	91	85	97	90	84	93	87
3	102	95	90	100	94	89	96	91
4	106	101	96	104	99	94	100	95
5	109	104	100	106	102	98	102	98

STRONG IP65 54W 6500K long								
Ceiling	80	80	80	70	70	70	50	50
Walls	70	50	30	70	50	30	70	50
Floor	20	20	20	20	20	20	20	20
0.6	57	45	38	56	45	38	55	44
0.8	67	55	47	66	55	47	64	54
1	75	64	57	74	63	56	72	65
1.25	83	72	65	81	71	64	78	70
1.50	88	78	70	86	77	70	83	75
2	95	86	79	93	85	79	89	82
2.50	99	91	85	97	89	84	93	87
3	102	95	90	100	94	89	96	91
4	106	100	96	104	99	94	99	95
5	109	104	100	106	102	98	102	98

DL SQUARE 13W 3000K								
Ceiling	80	80	80	70	70	70	50	50
Walls	70	50	30	70	50	30	70	50
Floor	20	20	20	20	20	20	20	20
0.6	61	50	43	60	49	43	59	49
0.8	71	60	53	70	59	53	68	59
1	79	68	62	78	68	61	76	69
1.25	86	76	69	84	75	69		

